

The 67th Annual Meeting of the International Society of Electrochemistry

Electrochemistry: from Sense to Sustainability

21-26 August, 2016

The Hague, The Netherlands

CONTENTS LIST

Organizing Committee	v
Symposium Organizers	vi-vii
Tutorial Lectures	viii
Plenary Lectures	ix
Prize Winners	x-xii
ISE Society Meetings	xiii
Poster Sessions	xii
General Information	inside front cover
Registration Hours during the Meeting	inside front cover
On Site Registration Fees	inside front cover
Lunches	inside front cover
Coffee Breaks	inside front cover
Internet Service	inside front cover
Accompanying Persons	inside front cover
Publications	xiv
Social Program: Receptions, Excursions and Banquet	xiv
Oral Presentation Program	
Monday, 22 August – Friday, 26 August	1
Poster Presentation Program - All Symposia	81
Author Index	178
ISE Society Information	204
Poster Plan Session 1 - Monday (Symposia 1, 2, 5, 6, 11)	215
Poster Plan Session 2 - Tuesday (Symposia 3, 4, 7, 10)	216
Poster Plan Session 3 - Wednesday (Symposia 8, 9, 12, 13, 14, 15, 16, 17, 18, 20)	217
Week Schedule	218
Symposium Schedule and Floor Plan	back cover

International Society of Electrochemistry, chemin du Closelet 2, 1006 Lausanne, Switzerland

Copyright © 2016

First published on the website <http://annual67.ise-online.org> 12 July 2016

All rights reserved. No part of this work may be reproduced, stored in a retrieval system or transmitted in any form or by any means, electronic, mechanical, photocopying, recording or otherwise, without prior written permission of the Publisher. No responsibility is assumed by the Publisher for any injury and/or damage to persons or property as a matter of product liability, negligence or otherwise, or from any use or operation of any methods, products, instructions or ideas contained in the material herein.

Printed in the Netherlands

Exhibitor booths

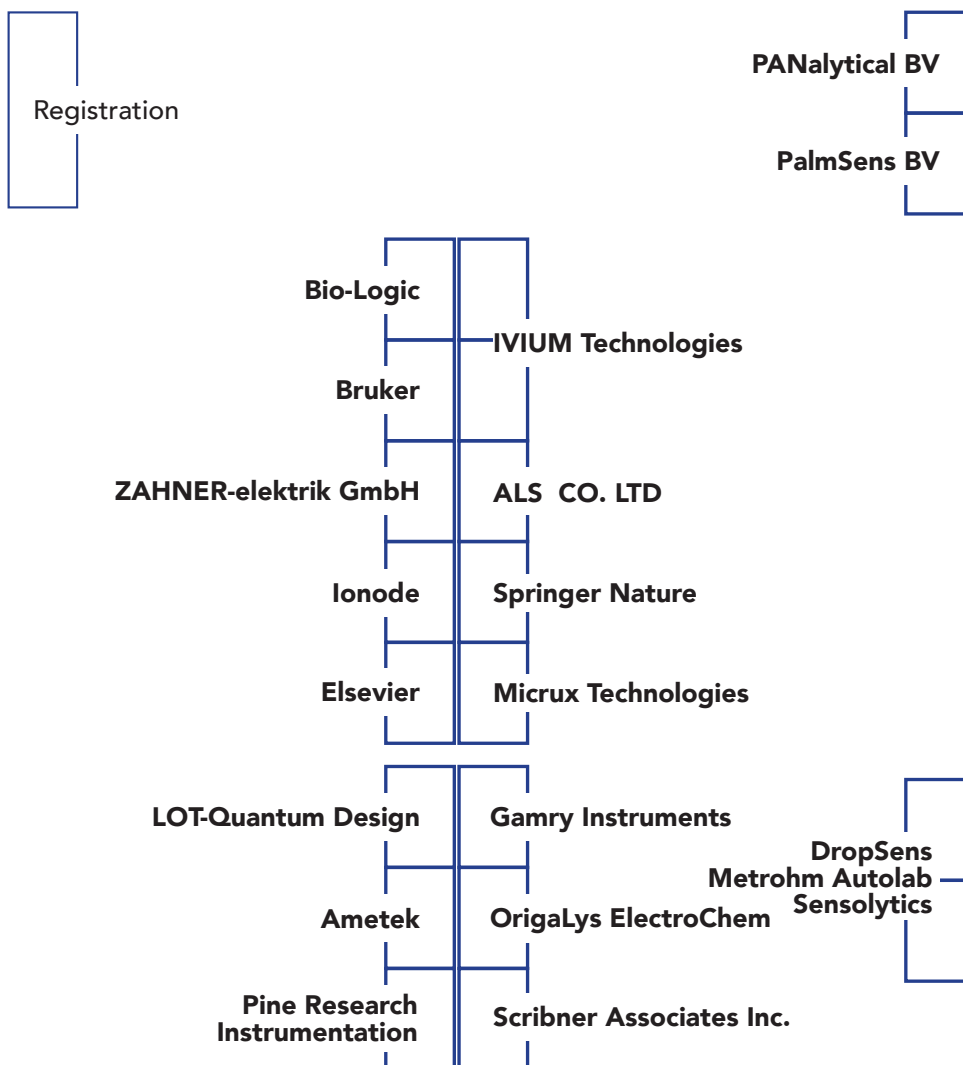

Exhibition Hours

Monday:	09:30-20:00
Tuesday:	09:30-18:30
Wednesday:	09:30-12:00
Thursday:	09:30-18:30
Friday:	09:30-12:00

Exhibitors



Elsevier



Gamry Instruments



DropSens



IVIUM Technologies



ALS Co. Ltd



Metrohm Autolab



Pine Research Instrumentation



Bio-Logic



Springer Nature



OrigaLys ElectroChem

Micrux Technologies



PalmSens BV



Ametek



Zahner-elektrik GmbH



LOT-QuantumDesign



Scribner Associates Inc.



PANalytical BV



Sensolytics



Bruker



Ionode

Sponsors



Den Haag

The Hague



Metrohm



BIP IMM CNRS



IJ Cambria Scientific Ltd



Pine Research Instrumentation

Symposium Support



PEC Corp



WETSUS



Helmholtz-Institute Ulm

Welcome Address

On behalf of the Organizing Committee, the Executive Committee of ISE, and the symposium organizers, we warmly welcome you to the city of The Hague and look forward to your participation in the 67th Annual Meeting of the International Society of Electrochemistry from 21st to 26th of August, 2016.

After Amsterdam (1958), Eindhoven (1973) and Maastricht (1987), the 2016 ISE Annual Meeting is the fourth Annual Meeting to be held in The Netherlands. The Hague (“Den Haag” or “’s-Gravenhage” in Dutch) is the third largest city in The Netherlands and has been the seat of the government of the Dutch Republic, and later of the Kingdom of the Netherlands, since 1588. Also the Dutch royal family currently resides in The Hague. The Hague was home to the world’s first peace conference in 1899 and has been an international city of peace and justice ever since. Today The Hague is a pleasant, green, and cosmopolitan city with an attractive historical city center, many parks, and the only Dutch city with a beach (“Scheveningen”). The Hague is home to many world-class museums, such the Mauritshuis (with famous paintings of Vermeer, Rembrandt, Rubens, and many other Dutch and Flemish masters), the Gemeentemuseum (with a unique collection of Mondriaan paintings), the Escher Museum, and the extraordinary Panorama Mesdag, a single painting museum with a panoramic view of Scheveningen in 1881 (Vincent Van Gogh said about the painting that “the only thing wrong about this painting is that there is nothing wrong about it”).

The Hague and the surrounding region of Holland have strong scientific and intellectual traditions. The Hague was home to the physicists and mathematicians Christiaan and Constantijn Huygens (both buried in the Sint Jacob church in the city center), Baruch Spinoza, and René Descartes. Nearby Leiden University (15 km to the North-East) is the oldest university in The Netherlands with a growing university campus in The Hague. As far as the history of electrochemistry is concerned, water electrolysis was first performed in Holland (in Haarlem in 1789), and the dimensionally stable anode was invented in an old Dutch gin distillery in Schiedam (near Rotterdam).

We sincerely hope that you will enjoy the cultural, culinary, touristic and scientific highlights that The Hague, The Netherlands, and the 2016 ISE Annual Meeting have to offer. The scientific theme of this year’s meeting “Electrochemistry: from Sense to Sustainability” underscores the breadth and importance of our field, and we believe that the scientific program, with five plenary lectures and twenty different symposia, offers you an exciting and timely panoramic view of the fundamental and applied opportunities and challenges of electrochemistry and electrochemical engineering. Most of all, we hope that the Annual Meeting in The Hague provides you with a pleasant setting to meet old and new friends and colleagues, to exchange scientific views and ideas, and to make new research plans.

Welkom in Den Haag!

Maarten Van Brussel and Marc Koper,
Co-chairs ISE Annual Meeting 2016

Organizing Committee

Christian Amatore, *France*

Maarten Biesheuvel, *the Netherlands*

Bernard Dam, *the Netherlands*

Justin Gooding, *Australia*

Annick Hubin, *Belgium*

Marc Koper, *the Netherlands (Co-Chair)*

Yunny Meas, *Mexico*

Peter Notten, *the Netherlands*

Mark E. Orazem, *USA*

Maarten Van Brussel, *the Netherlands (Co-Chair)*

Symposium Organizers

- Symposium 1: New Horizons in Analytical Electrochemistry**
Thomas Doneux (Coordinator), Université Libre de Bruxelles, Belgium
Annemie Adriaens, Universiteit Gent, Belgium
Priscilla Baker, University of Western Cape, South Africa
Fethi Bedioui, Chimie ParisTech, France
- Symposium 2: Nanostructured Materials in Electroanalytical Chemistry**
Daniel Mandler (Coordinator), Hebrew University of Jerusalem, Israel
Alison Downard, University of Canterbury, New Zealand
Stanley Lai, Twente University, the Netherlands
Liza Rassaei, Delft University of Technology, the Netherlands
- Symposium 3: New Approaches for Interfacing Electrochemistry and Biological Systems**
Elena Ferapontova (Coordinator), Aarhus University, Denmark
Renata Bilewicz, University of Warsaw, Poland
Karolien de Wael, University of Antwerp, Belgium
Serge Lemay, Twente University, the Netherlands
Fred Lisdat, Technical University of Wildau, Germany
- Symposium 4: Electrochemical Approaches in Diseases and Human Health**
Woonsup Shin (Coordinator), Sogang University, Korea
Fethi Bedioui, Chimie ParisTech, France
Marilia O. F. Goulart, Universidade Federal de Alagoas, Brazil
Susan M. Lunte, University of Kansas, USA
Lanqun Mao, Chinese Academy of Sciences, China
- Symposium 5: Current Progress in Microbial Electrochemical Technologies**
Xochitl Dominguez-Benetton (Coordinator), Flemish Inst Technological Research, Belgium
Bert Hamelers, Wetsus, the Netherlands
Korneel Rabaey, Universiteit Gent, Belgium
Uwe Schröder, TU Braunschweig, Germany
- Symposium 6: Novel Materials and Devices for Energy Storage: Batteries for Tomorrow's World**
Stefano Passerini (Coordinator), Helmholtz Institute UM/KIT, Germany
Erik Kelder, Delft University of Technology, the Netherlands
Robert Kosteki, Lawrence Berkeley National Lab, USA
Fokko Mulder, Delft University of Technology, the Netherlands
Peter Notten, Eindhoven University of Technology, the Netherlands
Marnix Wagemaker, Delft University of Technology, the Netherlands
- Symposium 7: Novel Materials and Devices for Energy Conversion and Storage: Fuel Cells, Electrolysers, Regenerative Fuel Cells and Flow Batteries**
Matthias Arenz (Coordinator), University of Copenhagen, Denmark
Andreas Friedrich, German Aerospace Center, Germany
Anne Hauch, Technical University of Denmark, Denmark
Robert Savinell, Case Western Reserve University, USA
- Symposium 8: Novel Materials and Devices for Energy Storage: Capacitors**
Elzbieta Frackowiak (Coordinator), Poznan University of Technology, Poland
Peter Coenen, VITO, Belgium
Wataru Sugimoto, Shinshu University, Japan
- Symposium 9: Capacitive Electrodes for Environmental Technology**
Maarten Biesheuvel (Coordinator), Wetsus and Wageningen University, the Netherlands
Chong Zheng Na, University of Notre Dame, USA
Matthew Suss, Technion Israel Institute of Technology, Israel
Linda Zou, University of South Australia, Australia
- Symposium 10: Electroactive, Functionalized and Nanostructured Materials and Composites: Modern Trends in Synthesis and Applications**
Magdalena Skompska (Coordinator), University of Warsaw, Poland
Marilia O.F. Goulart, Universidade Federal de Alagoas, Brazil
Arjan Hovestad, TNO, the Netherlands
Francesco Paolucci, Università di Bologna, Italy
Philippe Vereecken, IMEC, Belgium
Mikhail Vorotyntsev, M.V. Lomonosov Moscow State University, Russia

Symposium 11: Electrochemical Engineering for Improvement of Process Sustainability

Juan Peralta (Coordinator), Universidad de Guanajuato, Mexico
François Lapicque, Université de Lorraine, France
Guido Mul, Twente University, the Netherlands
Manuel Rodrigo, Universidad de Castilla-la-Mancha, Spain

Symposium 12: EC Power Sources: Principles of Materials, Design and Operation

Deborah Jones (Coordinator), Université de Montpellier, France
Peter Bouwman, HyET, the Netherlands
Eril Kjeang, Simon Fraser University, Canada
François Lapicque, Université de Lorraine, France

Symposium 13: Corrosion: The Electrochemistry of Corrosion and Approaches to Corrosion Protection

Mary P. Ryan (Coordinator), Imperial College London, UK
Nick Birbilis, Monash University, Australia
Shinji Fujimoto, Osaka University, Japan
Santiago Garcia, Delft University of Technology, the Netherlands
Wouter Hamer, Shell, the Netherlands
Herman Terryn, Vrije Universiteit Brussel, Belgium

Symposium 14: Combined Electro and Electrophoretic Deposition for Advanced Materials Synthesis

Aldo R. Boccaccini (Coordinator), University of Erlangen-Nuremberg, Germany
Begona Ferrari, CSIS Madrid, Spain
Arjan Mol, Delft University of Technology, the Netherlands
Marcel J. Rost, Leiden University, the Netherlands
Mary P. Ryan, Imperial College London, UK
Giovanni Zangari, University of Virginia, USA

Symposium 15: New Molecules - Synthesis, Fundamental Electron Transfer Properties and their Relationship with Molecular Action

Carlos Frontana (Coordinator), CIDETEQ, Mexico
Daniel Bélanger, University of Quebec, Canada
Dennis Hetterscheid, Leiden University, the Netherlands

Symposium 16: Physical and Interfacial Electrochemistry: Progress in Spectroscopy, Imaging and Theoretical Analysis

Gregory Jerkiewicz (Coordinator), Queen's University, Canada
Nuria Garcia-Araez, University of Southampton, UK
Annick Hubin, Vrije Universiteit Brussel, Belgium
Ryosuke Jinnouchi, Toyota R&D Labs, Japan
Masatoshi Osawa, Hokkaido University, Japan
Zhong-Qun Tian, Xiamen University, China

Symposium 17: "Attention: Theory Only"

Michael Eikerling (Coordinator), Simon Fraser University, Canada
Federico Calle-Vallejo, Leiden University, the Netherlands

Symposium 18: Electrochemistry, Photoelectrochemistry and Bioelectrochemistry of Artificial Photosynthesis: Recent Advances in CO₂ Conversion to Products

Deepak Pant (Coordinator), VITO, Belgium
Monica Baroso, Utrecht University, the Netherlands
Gabriele Centi, University of Messina, Italy
Brian Seger, DTU Lyngby, Denmark
Wilson Smith, Delft University, the Netherlands

Symposium 19: Electrochemistry in Action

Marc Koper (Coordinator), Leiden University, the Netherlands
Plamen Atanassov, University of New Mexico, USA
Maarten Van Brussel, Metrohm Autolab, the Netherlands

Symposium 20: General Session

Susana Cordoba de Torresi (Coordinator), University of Sao Paulo, Brazil
Claudine Buess-Herman, Université libre de Bruxelles, Belgium
Tom Breugelmans, University of Antwerp, Belgium
Yunny Meas, CIDETEQ, Mexico

Tutorial Lectures

Sunday, 21 August 2016

Location: World Forum Convention Center

Tutorial 1

Room : Yangtze 1

14:00 to 17:00

Nanoscale Electrochemical Imaging

Patrick Unwin, *Warwick University, UK*

Marcel Rost, *Leiden University, the Netherlands*

Tutorial 2

Room : Yangtze 2

14:00 to 17:00

Electrochemical Instrumentation

Tamas Pajkossy, *Hungarian Academy of Sciences, Hungary*

Soma Vesztegom, *Eötvös Lorand University, Hungary*

Tutorial 3

Room : Kilimanjaro

14:00 to 17:00

Water Desalination by Capacitive Deionization: Introduction & Basic Concepts

Maarten Biesheuvel, *Wetsus, the Netherlands*

Matthew Suss, *Technion Israel Institute of Technology, Israel*

15:30 to 15:45

Coffee break

Plenary Lectures

Location: King Willem Alexander

Monday, 22 August 2016



08:15 to 09:15

George Whitesides

(Harvard University, Cambridge, USA)

Paper, Electrochemistry, and Diagnostics for the Developing World

Tuesday, 23 August 2016



08:15 to 09:15

Linda Nazar

(University of Waterloo, Canada)

New Vistas in Electrochemical Energy Storage

Wednesday, 24 August 2016



08:15 to 09:15

Anders Nilsson

(University of Stockholm, Sweden)

Operando X-ray Studies of Electrocatalysis

Thursday, 25 August 2016



08:15 to 09:15

Serge Lemay

(Twente University, the Netherlands)

Electrochemical Nanofluidics: from Nanogaps to Nanocapacitors

Friday, 26 August 2016

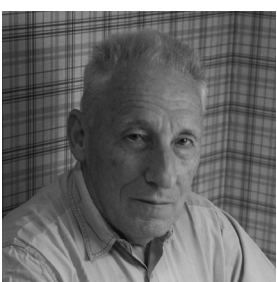

08:15 to 09:15

Yuri Pleskov

(A.N. Frumkin Institute of Physical Chemistry and Electrochemistry, Russia)

Alexander Frumkin and the Electrochemistry of Diamond in My Life

ISE Prize Winners 2015

Frumkin Memorial Medal



Yuri Pleskov, *A.N. Frumkin Institute of Physical Chemistry and Electrochemistry, Russia*

08:15 to 09:15, Friday, 26 August 2016, Plenary Lecture, King Willem Alexander

Alexander Frumkin and the Electrochemistry of Diamond in My Life

The Frumkin Memorial Medal is awarded to Yuri Pleskov for sustained seminal contributions across physical electrochemistry, notably for his work on the electrochemistry of semi-conductors, on photoelectrochemistry, on electron emission into electrolytes, and on the electrochemistry of synthetic diamond.

Prix Jacques Tacussel



Dan Bizzotto, *University of British Columbia, Canada*

Monday 22 August 2016 - 09:30-10:10 Symposium 16, Room Kilimanjaro

Studying lipid and thiol monolayer modified electrode surfaces using in-situ fluorescence microscopy

The Prix Jacques Tacussel is awarded to Dan Bizzotto in recognition to his contribution to the development of *in situ* electrochemical fluorescence microscopy and its application to molecular and biomolecular adsorption.

Katsumi Niki Prize for Bioelectrochemistry

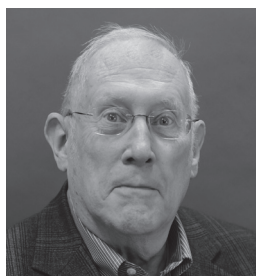

George S. Wilson, *University of Kansas, USA*

Wednesday 24 August 2016 - 09:30-09:50, Symposium 3, Room Yangtze 1

Bioelectrochemistry: The Nature of the Electrode-Biological Interface

The Katsumi Niki Prize for Bioelectrochemistry is awarded to George Wilson for his key role in understanding electron transfer processes of redox-active proteins on electrodes, protein immobilization on conducting surfaces and the effect of electrode surface on the protein structure and functions.

Tajima Prize



Yong-Sheng Hu, *Chinese Academy of Sciences, China*

Wednesday 24 August 2016 - 10:10-10:50, Symposium 6, Room Oceania

Prototype Na-Ion Batteries for Grid-Scale Energy Storage

The Tajima Prize is awarded to Yong-sheng Hu for his outstanding researches on rechargeable batteries, especially his recent pioneering studies on sodium-ion batteries.

Jaroslav Heyrovsky Prize for Molecular Electrochemistry



Daniel Little, *University of California, USA*

Monday 22 August 2016 - 09:30-10:10, Symposium 15, Room Everest

Recent Advances in Electroorganic Synthesis: Redox Mediators; Reusable Electrolytic Reaction Media; Redox Reactions Using a Simple Flow Apparatus

The Jaroslav Heyrovsky Prize for Molecular Electrochemistry is awarded to R. Daniel Little for his outstanding contributions in the field of organic electrosynthesis with the use of innovative electrocatalysts, the introduction of reusable electrolytes, which will facilitate up-scaling and flow-electrolysis and his mechanistic studies.

ISE Prize Winners 2015

Alexander Kuznetsov Prize for Theoretical Electrochemistry



Martin Z. Bazant, *Massachusetts Institute of Technology, USA*

Monday 22 August 2016 - 16:40-17:20, Symposium 17, Room Yangtze 2

Theory of Electrochemical Interfaces at High Voltage

The Aleksander Kuznetsov Prize for Theoretical Electrochemistry is awarded to Martin Bazant for his seminal studies at the forefront of the theory of electrokinetic phenomena in electrochemistry and electrochemical engineering.

Hans-Jürgen Engell Prize



Marcel Risch, *Massachusetts Institute of Technology, USA*

Thursday 25 August 2016 - 16:40-17:00, Symposium 7, King Willem Alexander

Electrocatalytic Redox Processes of Transition Metal Oxides in Aqueous Media probed by Operando X-Ray Absorption Spectroscopy

The Hans-Jürgen Engell Prize is awarded to Marcel Risch for his contributions in the development of earth-abundant catalyst materials for water oxidation and oxygen reduction.

ISE Prize for Applied Electrochemistry



Prabeer Barpanda, *Materials Research Center, Indian Institute of Science, Bangalore, India*

Wednesday 24 August 2016 - 09:50-10:10, Symposium 6, Room Oceania

Insights on New Phosphate Compounds for Na-ion Batteries

The ISE Prize for Applied Electrochemistry is awarded to Prabeer Barpanda in recognition of his contributions to the development of materials and their application in lithium-ion and sodium-ion batteries and super capacitors.

ISE Prize for Environmental Electrochemistry



Kangwoo Cho, *Korea Institute of Science and Technology, Korea*

Friday 26 August 2016 - 11:50-12:10, Symposium 20, Room Amazon

Wastewater Electrolysis Cell: Application of Environmental Electrochemistry for Water-Energy Nexus

The ISE Prize for Environmental Electrochemistry is awarded to Kangwoo Cho in recognition of his creative contributions to advances in the underlying technology of the electrochemical treatment of raw human wastewater.

Early Career Analytical Electrochemistry Prize of ISE Division 1



Bryan McCloskey, *University of California, USA*

Tuesday 23 August 2016 - 14:00-14:40, Symposium 1, Room Mississippi

Ion Solvation Effects in the Nonaqueous Li-O₂ Electrochemistry

The Early Career Analytical Electrochemistry Prize of ISE Division 1 is awarded to Bryan McCloskey in recognition of his contributions to understanding the fundamental chemistry of lithium-air batteries.

Electrochimica Acta Travel Awards for Young Electrochemists 2016

Maria Cuartero, Switzerland
Vlastimil Vyskocil, Czech Republic
Dejun Chen, USA

ISE Travel Awards for Young Electrochemists 2016

Lourdes Mónica Bravo Anaya, Mexico
Reza Younesi, Sweden
Ken Sakaushi, Japan
Meng Nan Chong, Malaysia
Jane Stockmann, France
Maria Escudero-Escribano, Denmark
Ulmas Zhumaev, Germany

Poster presentation session 1 - Monday

Symposia: s1, s2, 5, s6, s11

Poster set-up Monday: 08:30-10:30 *See poster locations map on page 215*

Poster Presentation: Monday, 22 August 2016: 11:00-12:30

(Lobby-Ground Floor)

Poster take-down Monday: 18:00-19:00

Poster presentation session 2 - Tuesday

Symposia: s3, s4, s7, s10

Poster set-up Tuesday: 08:30-10:30 *See poster locations map on page 216*

Poster Presentation: Tuesday, 23 August 2016: 11:00-12:30

(Lobby-Ground Floor)

Poster take-down Tuesday: 18:00-19:00

Poster presentation session 3 - Wednesday

Symposia: s8, s9, s12, s13, s14, s15, s16, s17, s18, s20

Poster set-up Wednesday: 08:30-10:30 *See poster locations map on page 217*

Poster Presentation: Wednesday, 24 August 2016: 11:00-12:30

(Lobby-Ground Floor)

Poster take-down Thursday: 14:00-16:00

ISE Society Meetings

Sunday, 21 August 2016

Opening Ceremony

17:20 to 19:00 › King Willem Alexander

Monday, 22 August 2016

Division Officers Luncheon Meeting

12:40 to 13:40 › Oceania

Regional Representatives Luncheon Meeting

12:40 to 13:40 › Oceania Foyer

Tuesday, 23 August 2016

Council Meeting

12:40 to 13:40 › Europe

Thursday, 25 August 2016

General Assembly

11:10 to 12:10 › King Willem Alexander

Division Meetings

12:40 to 13:40

Division 1 Analytical Electrochemistry › Yangtze 1

Division 2 Bioelectrochemistry › Yangtze 2

Division 3 Electrochemical Energy Conversion and Storage › Amazon

Division 4 Electrochemical Materials Science › Mississippi

Division 5 Electrochemical Process Engineering and Technology › Europe

Division 6 Molecular Electrochemistry › Oceania

Division 7 Physical Electrochemistry › Oceania Foyer

Friday, 26 August 2016

Closing Ceremony

12:15 to 12:30 › King Willem Alexander

See room locations on back cover

General Information

Publications

A special issue of the Society's journal, *Electrochimica Acta*, is planned based on selected original contributions made at the conference. Selection will be made by an international editorial Committee comprising the following Editors* and Guest Editors, one for each of the Symposia in which the meeting is articulated:

Symposium 1 Thomas Doneux, Symposium 2 Daniel Mandler, Symposium 3 Elena Ferapontova*, Symposium 4 Marilia O.F. Goulart, Symposium 5 Uwe Schroeder, Symposium 6 Stefano Passerini, Symposium 7 Matthias Arenz, Symposium 8 Wataru Sugimoto, Symposium 9 Matthew Suss, Symposium 10 Magdalena Skompska, Symposium 11 Francois Lapique, Symposium 12 Deborah Jones, Symposium 13 Nick Birbilis*, Symposium 14 Giovanni Zangari, Symposium 15 Daniel Bélanger, Symposium 16 Zhong-Qun Tian, Symposium 17 Michael Eikerling, Symposium 18 Deepak Pant

The Special Issues Editor, Sergio Trasatti, will co-ordinate the action of the editorial Committee and will be directly responsible for the review procedure. The Special Issue is planned to accommodate up to 180 papers.

Submission only on invitation of one of the Guest Editors

Submission time span: 27 August 2016 - 18 December 2016

Social Program

RECEPTIONS

Welcome Reception

Sunday, 21 August 2016, 19:00-20:00

After the Opening Ceremony on ground floor of World Forum Convention Center

Monday Reception

Monday, 22 August 2016, 18:40-20:00 on ground floor of World Forum Convention Center

Thursday Banquet

Thursday, 25 August 2016, 19:00

At the GRAND HOTEL AMRATH KURHAUS THE HAGUE

Gevers Deynootplein 30

2586 CK DEN HAAG SCHEVENINGEN

Price per person: EURO 115.-, Places are limited. All tickets for the banquet must be pre-booked and are non-refundable.

Transportation: via Tram 1 or Bus 21

EXCURSIONS

Wednesday, 24 August

Excursions (pre-, post- as well as Wednesday afternoon 24 August 2016 will be organized by Dutch Matters.

Please contact them directly <http://ise.dutch-matters.com>

Please note all excursions are based on a minimum number of 20 participants. All excursions will start and end at the World Forum The Hague.

HALF A DAY EXCURSION ROTTERDAM

Price : EURO 62,50 per person

Including coach and English speaking guide & specialized Architect guides during the excursion, and entrance of Kinderdijk.

HALF A DAY EXCURSION DELFT

Price : EURO 53,50 per person

Including coach and English speaking guide during the excursion, and entrance of the Porcelyne Fles and the Nieuwe Kerk.

HALF A DAY EXCURSION AMSTERDAM

Price : EURO 95,00 per person

Including coach and English speaking guide during the excursion and 1 hour boat trip and entrance of the Grachtenhuis.

HALF A DAY EXCURSION ZEELAND - NEELTJE JANS

Price : EURO 120,00 per person

Including coach and English speaking guide during the excursion, and entrance of the Neeltje Jans and a speech of a specialized architect.

Oral presentation program



Monday, 22 August 2016

ROOMS:	Mississippi	Yangtze 1	Oceania	King Willem Alexander	Oceania Foyer	Europe	Amazon	Everest	Kilimanjaro	Yangtze 2
SYMPOSIUM	Symposium 1	Symposium 3	Symposium 6	Symposium 7	Symposium 8	Symposium 11	Symposium 13	Symposium 15	Symposium 16	Symposium 17
08:15 - 09:15	Plenary Lecture: George Whitesides (King Willem Alexander)									
09:30 - 09:50	Conor Hogan	Jens Ulstrup	Martin Wilkening	Fabio Dionigi	Katsuhiko Naoi	Ann Cornell	E. Ramirez-Alvarez	R. Daniel Little	Dan Bizzotto	A.A. Komyshv
09:50 - 10:10	E. Witkowska Nery		Rosa Robert	Ioannis Spanos		P. Gran. Mendoza	Polina Volovitch			
10:10 - 10:30	Annick Hubin	Christophe Léger	Yue Ma	Arno Bergmann	François Béguin	Jacques Wijenberg	Xiaolong Zhang	T. Jane Stockmann	Zhong-Qun Tian	Michael Urbakh
10:30 - 10:50		Marcos Pita	Michal Struzik	Ilan Stephens	Jan Ronsmans	Adriano Gomes	Xia Zhao	Dominique Lorcy	J. Rodriguez Lopez	Priyamvada Goyal
10:50 - 11:10	Coffee Break &									
11:10 - 11:30										
11:30 - 11:50										
11:50 - 12:10										
12:10 - 12:30										
12:40 - 13:40	Lunch									
	Division Officers Meeting									
	Regional Repres. Meeting									
	Lunch									
14:00 - 14:20	Liza Rassaei	Michael Hill	Brett Lucht	Marion Chandesris	G. Zheng Chen	Martin Paidar	H. Kazmierczak	Patrick Unwin	J. M. Feilu Martinez	Jan Rossmel
14:20 - 14:40	Jin Cui			Magali Cochet	Masashi Ishikawa		V. Shkirskiy		Daniel Hanß	Minoru Otani
14:40 - 15:00	Kosuke Ino	Juan M. Artes	Fabian Jeschull	Renate Hiesgen	Andrea Balducci	Martin Prokop	Rolandas Verbickas	Alvaro Colina	Ludwig Kibler	Jean.-S. Filhol
15:00 - 15:20	Huijie Zhang	David Waideck	Y. Emre Durmus	Viktor Hacker	Nicolas Jäckel	Antoine Allanore	Jaideep Kulkarni	Martina Cizkova	M. Escu.-Escribano	Ryosuke Jimmouchi
15:20 - 15:40	Alexander Kuhn	L. M. Bravo Anaya	Daniel Buchholz	Simon Thiele	Roberto M. Torresi	Vincent Feynerol	H. O. Curkovic	Biprajit Sarkar	Dejun Chen	Eckhard Spohr
15:40 - 16:00	Serena Arnaboldi	R. Miranda-Castro	Christoph Bondue	Jaeyoung Lee	Gaëtan Buwat	Miguel Sandoval	Qinghong Fang	Xiaowei Li	A. Cristina Garcia	Heine Hansen
16:00 - 16:20	Vera Eßmann	Olga Swiech	Gleb Yushin		Mara Serrapede	Theo Tzedakis		Alan Liska	Thomas Doneux	Fritz Scholz
16:20 - 16:40	Coffee Break									
16:40 - 17:00	I-Ming Hsing	Mathieu Etienne	Emanuel Peled	Luis Castanheira	Vitor L. Martins	Thomas Turek		Andrew Doherty	Andrew Gewirth	Martin Z. Bazant
17:00 - 17:20		Włodzimierz Kutner	Robert Dominko	A. Zerafjanin	Francesca Soavi	Onofrio Scialdone	S. Virtanen			
17:20 - 17:40	Benoît Piro	Vlastimil Vyskocil	Gints Kucinskis	Veronica Celorrio	Guangyue Liao	Elisa Sechi	Mario Aparicio	Mauricio Isaacs	Guy Denuaut	Andrei Kulikovskiy
17:40 - 18:00	Gilbert Nöll	Yinglin Zhou	Dominic Bresser	Oscar Diaz-Morales	Eduarne Redondo	Ioanna Kalaitzidou	Sebastian Feihl	Abdirisak A. Isse	Yan-Xia Chen	Hartmut Löwen
18:00 - 18:20	Hjalmar Permentier	I. Alvarez-Martos	Nobuko Yoshimoto	Mario Bärtsch	Hai Yen Tran	Paul Kenis	Yan Chen	Haidong Li	Enrique Herrero	D. Jan Bonthuis
18:20 - 18:40	Hong-Yuan Chen	Stanislav Trashin	Moustafa Sanad	Li Wang	P. Babuchowska	Tsuyoshi Hoshino	Enrico Marsili	Ismael Diez-Perez	Kohei Uosaki	J. M. Garcia Lastra
18:40 - 20:00	Reception									

POSTER SESSION 1 (s1, s2, 5, s6, s11)

Monday, 22 August 2016, Morning

Plenary Lecture

Room : King Willem Alexander

Chaired by: J. Justin Gooding

08:15 to 09:15

George Whitesides (Harvard University, Cambridge, USA)

[Paper, Electrochemistry, and Diagnostics for the Developing World](#)

01 New Horizons in Analytical Electrochemistry

Room : Mississippi

Chaired by: Alexander Kuhn

09:30 to 09:50 INVITED

Conor Hogan (Dept. of Chemistry & Physics, La Trobe University, Melbourne, Australia), Kiran Bano, Seng Loke, Darrell Elton

[Android Voltammetry: Use of a mobile device as an instrument for voltammetric analysis](#)

09:50 to 10:10

Emilia Witkowska Nery (Department of Electrode Processes, Institute of Physical Chemistry, Polish Academy of Sciences, Warsaw, Poland), Lauro Kubota

[Paper-based electronic tongue systems and biosensors](#)

10:10 to 10:50 KEYNOTE

Annick Hubin (Electrochemical and Surface Engineering, Vrije Universiteit Brussel, Brussel, Belgium), Lucia Fernandez Macia, Rik Pintelon

[New Approaches for Reliable Parameter Estimation for Electrochemical Systems](#)

10:50 to 11:10

Coffee Break

s03 New Approaches for Interfacing Electrochemistry and Biological Systems

Room : Yangtze 1

Chaired by: Isabel Alvarez-Martos and Christophe Léger

09:30 to 10:10 KEYNOTE

Jens Ulstrup (Department of Chemistry, Technical University of Denmark, Kgs. Lyngby, Denmark), Qijin Chi, Michael J. Ford, Arnab Halder, Noel S. Hush, Jeffrey R. Reimers, Jingdong Zhang

[The Au-S bond and SAM-protein contact in long-range electron transfer of pure and biomimetic metalloproteins via functionalized alkanethiol linkers](#)

10:10 to 10:30

Christophe Léger (Bioénergétique et Ingénierie des Protéines, CNRS/AMU, Marseille, France), Adam Kubas, Christophe Orain, David de Sancho, Laure Saujet, Matteo Sensi, Charles Gauquelin, Isabelle Meynial-Salles, Philippe Soucaille, Hervé Bottin, Carole Baffert, Vincent Fourmond, Robert Best, Jochen Blumberger,

[Studying the Reaction of FeFe Hydrogenases with O₂ using Direct Electrochemistry, Molecular Dynamics, DFT and Site-Directed Mutagenesis](#)

10:30 to 10:50

Marcos Pita (Biocatalysis, Instituto de Catálisis - CSIC, Madrid, Spain), Oscar Gutierrez-Sanz, Paolo Natale, Ileana Marquez, Marta C. Marques, Sonia Zacarias, Ines A.C. Pereira, Ivan Lopez-Montero, Antonio L. De Lacey, Marisela Velez

[H₂-fueled ATP Synthesis on an Electrode: Mimicking Cellular Respiration](#)

10:50 to 11:10

Coffee Break

s06 Novel Materials and Devices for Energy Storage: Batteries for Tomorrow's World

Room : Oceania

Chaired by: Stefano Passerini and Martin Wilkening

09:30 to 09:50 INVITED

Martin Wilkening (Institute for Chemistry and Technology of Materials, Graz University of Technology, Graz, Austria)

[Li Ion Dynamics in Solids as Seen by Time-Domain NMR](#)

09:50 to 10:10

Rosa Robert (Electrochemistry Laboratory, Paul Scherrer Institut, Villigen PSI, Switzerland), Petr Novák

[Li-ion \(de-\)insertion mechanism of a LiNi_{0.8}Co_{0.15}Al_{0.05}O₂ electrode: insights into the first charge activation mechanism and its impact on the irreversible charge "loss"](#)

10:10 to 10:30

Yue Ma (Structural Chemistry, Uppsala University, Uppsala, Sweden), Kristina Edström

[Surface Modification Strategies of High Capacity Anodes towards Exceptional Robust Cycling](#)

10:30 to 10:50 INVITED

Michal Struzik (Electrochemical Materials, Department of Materials, ETH Zurich, Zurich, Switzerland), Iñigo Garbayo, Reto Pfenninger, Semih Afyon, Michael Rawlence, Jennifer L. M. Rupp

[All Solid State Li-Garnet-Based Battery Materials and Devices](#)

10:50 to 11:10

[Coffee Break](#)

s07 Novel Materials and Devices for Energy Conversion and Storage: Fuel Cells, Electrolysers, Regenerative Fuel Cells and Flow Batteries

Room : King Willem Alexander

Chaired by: Piotr Zelenay

09:30 to 09:50

Fabio Dionigi (Department of Chemical Engineering, Technische Universität Berlin, Berlin, Germany), Thomas Merzdorf, Hannes Sarodnik, Arno Bergmann, Jakub Drnec, Peter Strasser

[In Operando X-ray Based Structural Investigation of NiFe Layered Double Hydroxide during the Oxygen Evolution Reaction](#)

09:50 to 10:10

Ioannis Spanos (Heterogeneous Reactions, Max Planck Institute for Chemical Energy Conversion, Muelheim an der Ruhr, Germany), Alexander Auer, Chinmoy Ranjan, Robert Schloegl

[Electrochemical flow cell for the assessment of OER catalyst stability and activity](#)

10:10 to 10:30

Arno Bergmann (Department of Chemistry, Technische Universität Berlin, Berlin, Germany), Elias Martinez-Moreno, Detre Teschner, Petko Chernev, Manuel Gliech, Jorge Ferreira de Araujo, Tobias Reier, Holger Dau, Peter Strasser

[On the Catalytically Active State of Co oxide Electrocatalysts for Oxygen Evolution Reaction in Neutral Electrolyte and Their Structure-Activity Correlations](#)

10:30 to 10:50 INVITED

Ifan Stephens (Physics, Technical University of Denmark, Kongens Lyngby, Denmark)

[Oxygen evolution in acid media on model catalysts based on precious and non-precious metal oxides](#)

10:50 to 11:10

Coffee Break

s08 Novel Materials and Devices for Energy Storage: Capacitors

Room : Oceania Foyer

Chaired by: Elzbieta Frackowiak and John R. Miller

09:30 to 10:10 KEYNOTE

Katsuhiko Naoi (Advanced Capacitor Research Center, Tokyo University of Agriculture & Technology, Koganei, Japan), Wako Naoi

[Hybrid Supercapacitors: Their Evolution to Second and Third Generations](#)

10:10 to 10:30 INVITED

François Béguin (Institute of Chemistry and Technical Electrochemistry, Poznan University of Technology, Poznan, Poland), Pawel Jezowski, Elise Deunf, Olivier Crosnier, Philippe Poizot, Thierry Brousse

[Simplified lithium-ion capacitor with porous carbon and sacrificial lithiated material in the positive electrode](#)

10:30 to 10:50 INVITED

Jan Ronsmans (Emerging Technologies, JSR Micro, Leuven, Belgium)

[Advances in Lithium Ion Capacitors](#)

10:50 to 11:10

Coffee Break

s11 Electrochemical Engineering for Improvement of Process Sustainability

Room : Europe

Chaired by: *Henry Bergmann*

09:30 to 09:50 INVITED

Ann Cornell (Applied Electrochemistry, KTH Royal Institute of Technology, Stockholm, Sweden), Nina Simic

[The Role of Chromate in Chlorate Electrolysis](#)

09:50 to 10:10

P. Granados Mendoza (Chemical Engineering and Chemistry, Technische Universiteit Eindhoven, Eindhoven, Netherlands), S. Moshtarikhah, Thijs de Groot, J.T.F. Keurentjes, J.C. Schouten, J. van der Schaaf

[Process intensification of the chlor-alkali electrolysis by using a rotor-stator spinning disc membrane electrolyzer](#)

10:10 to 10:30

Jacques Wijenberg (Research & Development, IJmuiden Technology Centre, Tata Steel, IJmuiden, Netherlands), Arnoud de Voofs, Marc Koper

[Oxidation Reactions in Trivalent Chromium Electrolytes at a Catalytic Mixed Metal Oxide or Platinum Coating](#)

10:30 to 10:50

Adriano Gomes (Department of Chemistry and Molecular Biology, University of Gothenburg, Gothenburg, Sweden), Annicka Sellin, Nina Simic, Mats Wildlock, Elisabet Ahlberg

[Electrochemical Studies of Deposited Cr \(III\) Oxide Specie: Water Reduction Selectivity and Kinetics](#)

10:50 to 11:10

Coffee Break

s13 Corrosion: The Electrochemistry of Corrosion and Approaches to Corrosion Protection

Room : Amazon

Chaired by: *Santiago Garcia*

09:30 to 09:50

Elizeth Ramírez-Álvarez (Physics, Technical University of Munich, Munich, Germany), Konrad Schönleber, Katharina Krischer

[New insights into the mechanism of the stationary and oscillatory electrocorrosion of Si](#)

09:50 to 10:10

Polina Volovitch (Institut de Recherche de Chimie Paris, Chimie ParisTech, Paris, France), Alina Maltseva, Caroline de Faria Barros, Viacheslav Shkirskiy, Grégory Lefèvre

[Effect of pH on growth and barrier properties of brucite film on Mg](#)

10:10 to 10:30

Xiaolong Zhang (Corrosion, Endures BV, Den Helder, Netherlands), Nanni Noel, Gabriele Ferrari, Martijn Hoogeland

[Effect of Inclusions on Localized Corrosion of Chain Steel in Seawater](#)

10:30 to 10:50

Xia Zhao (Key Laboratory of Marine Environmental Corrosion and Bio-fou, Institute of Oceanology, Chinese Academy of Science, Qingdao, China), Baorong Hou

[MoS₂/Epoxy composite coating and its anticorrosion performance on carbon steel](#)

10:50 to 11:10

Coffee Break

s15 New Molecules - Synthesis, Fundamental Electron Transfer Properties and their Relationship with Molecular Action

Room : Everest

Chaired by: Patrick Unwin

09:30 to 10:10 KEYNOTE

JAROSLAV HEYROVSKY PRIZE FOR MOLECULAR ELECTROCHEMISTRY

R. Daniel Little (Chemistry and Biochemistry, University of California Santa Barbara, Santa Barbara, USA)

[Recent Advances in Electroorganic Synthesis: Redox Mediators; Reusable Electrolytic Reaction Media: Redox Reactions Using a Simple Flow Apparatus](#)

10:10 to 10:30

T. Jane Stockmann (ITODYS, Université Paris Diderot, Paris, France), Jean-Marc Noël, Ali Abou-Hassan, Catherine Combellas, Frederic Kanoufi

[Facilitated Lewis acid transfer by phospholipids at a water|CHCl₃ interface towards biomimetic and energy applications](#)

10:30 to 10:50 INVITED

Dominique Lorcy (Institut de Sciences Chimiques de Rennes, University of Rennes 1, Rennes, France)

[Sulfur Rich \$\pi\$ -Electron Acceptors: Design and Electronic Properties](#)

10:50 to 11:10

[Coffee Break](#)

s16 Physical and Interfacial Electrochemistry: Progress in Spectroscopy, Imaging and Theoretical Analysis

Room : Kilimanjaro

Chaired by: Philip Bartlett

09:30 to 10:10 KEYNOTE - **PRIX JACQUES TACUSSEL**

Dan Bizzotto (Chemistry, The University of British Columbia, Vancouver, Canada), Zhinan Landis Yu, Jannu Casanova-Moreno, Amanda Musgrove

[Studying lipid and thiol monolayer modified electrode surfaces using in-situ fluorescence microscopy](#)

10:10 to 10:30

Zhong-Qun Tian (State Key Laboratory of Physical Chemistry of Solid Surfaces, Xiamen University, Xiamen, China), Yu Wang, Xiao-Bing Ding, Xiao-Yu Cao

[A Physicochemical Approach to Fabricate 2D/1D Molecule Assemblies Assisted by Combined Photo- and Electro-Chemical Methods](#)

10:30 to 10:50

Joquin Rodriguez Lopez (Department of Chemistry, University of Illinois at Urbana-Champaign, Urbana, USA), Zachary Barton, Mark Burgess, Jingshu Hui, Jiarui Zhang, Kenneth Hernandez-Burgos

[In Situ Mapping of Ionic Reactivity in Metal, Graphene and Polymeric Battery Electrodes Using Versatile Electrochemical Probes](#)

10:50 to 11:10

Coffee Break

s17 Attention: Theory Only

Room : Yangtze 2

Chaired by: Michael Eikerling

09:30 to 10:10 KEYNOTE

Alexei A. Kornyshev (Chemistry, Imperial College London, London, United Kingdom)

[Electrochemically Tuned Metamaterials: New Scenarios Navigated by Theory](#)

10:10 to 10:30

Michael Urbakh (School of Chemistry, Tel Aviv University, Tel Aviv, Israel), Oscar Fajardo, Fernando Bresme, Alexei A. Kornyshev

[Electrotunable Friction with Ionic Liquid Nanoscale Films](#)

10:30 to 10:50

Priyamvada Goyal (Department of Engineering Science, University of Oxford, Oxford, United Kingdom), Charles Monroe

[Coupling of Material, Charge, and Momentum Transport in Liquid and Solid Electrolytes](#)

10:50 to 11:10

Coffee Break

Monday, 22 August 2016, Afternoon

s01 New Horizons in Analytical Electrochemistry

Room : Mississippi

Chaired by: Conor Hogan and Liza Rassaei

14:00 to 14:20 INVITED

Liza Rassaei (Chemical Engineering, TUDelft, Delft, Netherlands), Klaus Mathwig

[Controlling Selectivity in an Electrochemical Nanofluidic Device](#)

14:20 to 14:40

Jin Cui (MESA+ Institute for Nanotechnology, University of Twente, Enschede, Netherlands)

[Potential-controlled Adsorption and Separation of Redox Species in Electrochemical Nanofluidic Devices](#)

14:40 to 15:00

Kosuke Ino (Graduate School of Environmental Studies, Tohoku University, Sendai, Japan), Yusuke Kanno, Kumi Inoue, Atsushi Suda, Ryota Kunikata, Masahki Matsudaira, Hitoshi Shiku, Tomokazu Matsue

[Colorization of electrochemical imaging for cell analysis using a large-scale integration \(LSI\) device](#)

15:00 to 15:20

Huijie Zhang (Center for Electrochemical Sciences - CES, Ruhr University Bochum, Bochum, Germany), En Ning Saw, T. Abdulazim, P. Fortgang, T. Oellers, F. Feng, Alfred Ludwig, P. Levkin, Nicolas Plumeré

[Microarray of Electrochemical Droplet Cells](#)

15:20 to 15:40 INVITED

Alexander Kuhn (ENSCBP, University Bordeaux, Pessac, France), Thittaya Yutthalekha, Chularat Wattanakit, Veronique Lapeyre, Somkiat Nokbin, Chompunuch Warakulwit, Jumras Limtrakul

[Chiral Recognition at Nanostructured Metal Surfaces](#)

15:40 to 16:00

Serena Arnaboldi (Chemistry, Università degli Studi di Milano, Milan, Italy), Patrizia Mussini, Tiziana Benincori, Andrea Penoni, Francesco Sannicolò

[Highly Enantioselective “Inherently Chiral” Film Electrodes at Work](#)

16:00 to 16:20

Vera Eßmann (Analytical Chemistry, Center for Electrochemical Sciences, Ruhr-Universität Bochum, Bochum, Germany), Stefan Barwe, Justus Masa, Wolfgang Schuhmann

[Simultaneous yet independent stability assessment at individual poles of a bifunctional catalyst with bipolar electrochemistry](#)

16:20 to 16:40

Coffee Break

16:40 to 17:20 KEYNOTE

I-Ming Hsing (Division of Biomedical Engineering, Hong Kong University of Science and Technology, Hong Kong, China)

[Enzyme-Free Sensing of Nucleic Acid Analytes and Extracellular Monitoring of Cellular Ions by Organic Electrochemical Transistor](#)

17:20 to 17:40

Benoît Piro (Laboratory ITODYS, University Paris Diderot, Paris, France), Denjun Wang, Dihia Benaoudia, Vincent Noël, Guillaume Anquetin, Steeve Reisberg

[Bisphenol a Sensor with Low Voltage Electrolyte-Gated Organic Transistor](#)

17:40 to 18:00

Gilbert Nöll (Chemistry-Biology, University of Siegen, Siegen, Germany), Qiang Su

[New Strategies for the Label-Free Optical Detection of Oligonucleotides or Antibodies with Surface Plasmon Fluorescence Spectroscopy](#)

18:00 to 18:20

Hjalmar Permentier (Analytical Biochemistry, University of Groningen, Groningen, Netherlands), Floris van den Brink, Tao Zhang, Liwei Ma, Johan Bomer, Mathieu Odijk, Wouter Olthuis, Rainer Bischoff, Albert van den Berg

[Electrochemical Protein Cleavage in a Microfluidic Cell with Integrated Boron Doped Diamond Electrode](#)

18:20 to 18:40

Hong-Yuan Chen (Chemistry, Nanjing University, Nanjing, China)

[DNA Labeling Generates a Unique Amplification Probe for Sensitive Photoelectrochemical Immunoassay of HIV-1 p24 Antigen](#)

s03 New Approaches for Interfacing Electrochemistry and Biological Systems

Room : Yangtze 1

Chaired by: Elena E. Ferapontova and Rebeca Miranda-Castro

14:00 to 14:40 KEYNOTE

Michael Hill (Chemistry, Occidental College, Los Angeles, USA)

[A Collector-Generator Assay for Protein Activity based on Electrochemistry at DNA-Modified Surfaces: Detection of Transcription Factors and Human Methyltransferase in Tumors](#)

14:40 to 15:00

Juan Manuel Artes Vivancos (Biophysics, Photosynthesis & Energy, Faculty of Sciences, Vrije Universiteit Amsterdam, Amsterdam, Netherlands), Yuanhui Li, Jianqing Qi, M.P. Anantram, Zimple Matharu, Erkin Seker, Joshua Hihath

[Conformational Gating of the Electrical Properties of Oligonucleotides](#)

15:00 to 15:20 INVITED

David Waldeck (Chemistry, University of Pittsburgh, Pittsburgh, USA), Edward Beall, Emil Wierzbinski

[Charge Transport and Molecular Conductance of Nucleic Acids and Proteins on Electrodes](#)

15:20 to 15:40

Lourdes Mónica Bravo Anaya (Ingeniería Química, Universidad de Guadalajara, Guadalajara, Mexico), J.F. Armando Soltero, Erika Roxana Larios Durán

[DNA molecules adsorption onto metal surfaces through a novel technique: Modulation of the Interfacial Capacitance \(MIC\)](#)

15:40 to 16:00

Rebeca Miranda-Castro (Departamento de Química Física y Analítica, Oviedo, Spain), Noemí de-los-Santos-Álvarez, Arturo J. Miranda-Ordieres, María Jesús Lobo-Castañón

[Tuning the packing density of DNA on gold surfaces to retain biological functionality](#)

16:00 to 16:20

Olga Swiech (Faculty of Chemistry, University of Warsaw, Warsaw, Poland), Agata Krzak, Grzegorz Wojciuk, Tomasz Stepkowski, Marcin Kruszewski, Renata Bilewicz

[The Influence of Modified Cyclodextrins on the Anthracycline - DNA Interactions](#)

16:20 to 16:40

Coffee Break

16:40 to 17:00 INVITED

Mathieu Etienne (CNRS, LCPME, Nancy, France)

[Immobilization of redox proteins and bacteria in sol-gel materials by electrochemistry and for electrochemistry](#)

17:00 to 17:20

Włodzimierz Kutner (Department of Physical Chemistry of Supramolecular Complexes, Institute of Physical Chemistry, Polish Academy of Sciences, Warsaw, Poland), Maciej Cieplak, Katarzyna Szwabinska, Marta Sosnowska, Chandra B. KC, Pawel Borowicz, Krzysztof Noworyta, Francis D'Souza

[Conducting molecularly imprinted polymers for determination of selected small proteins](#)

17:20 to 17:40

Vlastimil Vyskocil (Department of Analytical Chemistry, Charles University in Prague, Faculty of Science, Prague, Czech Republic), Tomas Navratil, Miroslav Fojta

[Artificial Cell – An Integrated In Vitro Model Based on Specific Electrochemical Biosensing Systems](#)

17:40 to 18:00

Yinglin Zhou (College of Chemistry and Molecular Engineering, Peking University, Beijing, China), Dewen Zhang, Ji Nie, Fangting Zhang, Xinxiang Zhang

[The application of G-quadruplex in label-free homogeneous electrochemical biosensors](#)

18:00 to 18:20

Isabel Alvarez-Martos (Interdisciplinary Nanoscience Center (iNANO), Aarhus University, Aarhus, Denmark), Elena E. Ferapontova

[Wiring of Biomolecules by Methylene Blue-Modified Third Generation Poly\(amidoamine\) Dendrimers](#)

18:20 to 18:40

Stanislav Trashin (Chemistry, University of Antwerp, Antwerp, Belgium), Mats de Jong, Silvia Dewilde, Karolien De Wael

[Electrochemical Study of Two Hexa-coordinate Globins \(Human Neuroglobin and GLB-12 from C. Elegans\) Towards Molecular Mechanisms, Biological Roles, and Biosensing Application](#)

s06 Novel Materials and Devices for Energy Storage: Batteries for Tomorrow's World

Room : Oceania

Chaired by: Robert Kostecki and Brett Lucht

14:00 to 14:40 KEYNOTE

Brett Lucht (Chemistry, University of Rhode Island, Kingston, USA)

[Development of novel electrolyte additives for designed surface modification](#)

14:40 to 15:00

Fabian Jeschull (Structural Chemistry, Uppsala University, Uppsala, Sweden), Fredrik Lindgren, Matthew J. Lacey, Fredrik Björefors, Kristina Edström, Daniel Brandell

[Influence of Inactive Electrode Components on Degradation Phenomena in Nano-Si Electrodes for Li-ion Batteries](#)

15:00 to 15:20

Yasin Emre Durmus (Fundamental Electrochemistry (IEK-9), Forschungszentrum Jülich GmbH, Jülich, Germany), Steffen Alexander Kayser, Ozgur Aslanbas, Hermann Tempel, L.G.J. de Haart, Josef Granwehr, Hans Kungl, Ruediger-A. Eichel

[Investigating Discharge Performance of Si-air Batteries with Alkaline Electrolyte](#)

15:20 to 15:40

Daniel Buchholz (Karlsruhe Institute of Technology, Helmholtz Institute Ulm, Ulm, Germany), Marlou Keller, Christoph Vaalma, Xinwei Dou, Stefano Passerini

[Advances in Na-ion Battery Materials](#)

15:40 to 16:00

Christoph Bondue (Institute of Physical and Theoretical Chemistry, University of Bonn, Bonn, Germany), Philip Reinsberg, Helmut Baltruschat

[The Effect of Additives as a Probe for the Effect of Solvent Properties on the Oxygen Reduction Reaction in Organic Solvents](#)

16:00 to 16:20 INVITED

Gleb Yushin (Materials Science and Engineering, Atlanta, USA), Feixiang Wu, Wentian Gu, Jung-Tae Lee, Naoki Nitta, Hyea Kim, Huan-Ting Lin, Jiabin Huang, Alexandre Magasinski

[Nanocomposite Cathodes for Lithium-Sulfur and Lithium-Metal Fluoride Chemistries](#)

16:20 to 16:40

Coffee Break

16:40 to 17:00 INVITED

Emanuel Peled (School of Chemistry, Tel-Aviv University, Tel-Aviv, Israel), Fernando Patolsky, Diana Golodnitsky, Guy Davidi, Dan Schneier, Meital Goor, Kathrin Freedman, Keren Goldshtein

[The Effects of Primary and Secondary SEI Growth on the Performance-Fading of Silicon Anode](#)

17:00 to 17:20 INVITED

Robert Dominko (Laboratory for Materials Chemistry, National Institute of Chemistry, Ljubljana, Slovenia), Alen Vizintin, Manu U.M. Patel, Iztok Arcon, Lorenzo Stievano, Giuliana Aquilanti

[The mechanism of polysulfide formation in Li-S batteries](#)

17:20 to 17:40

Gints Kucinskis (Department of Physical Chemistry of Solids, Max Planck Institute for Solid State Research, Stuttgart, Germany), Nils Ohmer, Bernhard Fenk, Joachim Maier

[Lithiation Dynamics in LiFePO₄ on a Single- and Multi-Particle Level](#)

17:40 to 18:00

Dominic Bresser (INAC/SPrAM/PCI, CEA, Grenoble, France), Mélody Leclere, Laurent Bernard, Patrice Rannou, Hakima Mendil-Jakani, Sandrine Lyonnard, Lionel Picard

[Ionic Liquid-Crystalline Single-Ion Conductors – Realizing Arrhenius-like Li[±] Transport in Organic Electrolytes](#)

18:00 to 18:20

Nobuko Yoshimoto (Graduate School of Science and Engineering for Innovation, Yamaguchi University, Ube, Japan), Taisuke Hazama, Kenta Fujii, Yanko Todorov, Masahiro Aoki, Hideyuki Mimura, Masayuki Morita

[Nonflammable Gel Electrolyte with Tetra-armed Polymer Network for Li-ion Batteries](#)

18:20 to 18:40

Moustafa Sanad (Minerals Processing Technology, Central Metallurgical R & D Institute, Tebbin, Egypt), Doha Harbouai, Cecile Rossignol, Philippe Dumaz, El-Kebir Hlil, Noureddine Amdouni, Said Obbade

[New Investigation of Positive Electrode Materials for Next Generation of Sodium Ion Batteries](#)

s07 Novel Materials and Devices for Energy Conversion and Storage: Fuel Cells, Electrolysers, Regenerative Fuel Cells and Flow Batteries

Room : King Willem Alexander

Chaired by: K. Andreas Friedrich

14:00 to 14:20

Marion Chandesris (LITEN, CEA, Grenoble, France), Laure Guétaz, Pascal Schott, Jean-Philippe Poirot-Crouvezier, Sylvie Escribano

[Investigation of degradation heterogeneities in PEMFC stacks combining local in-situ measurements, post-mortem analysis and multiphysic simulations](#)

14:20 to 14:40

Magali Cochet (ENE, Paul Scherrer Institute, Villigen, Switzerland), Patricia Groeninger, Antoni Forner-Cuenca, Dirk Scheuble, Pierre Boillat

[Neutron Imaging Characterization for Optimization of an Evaporation Cooled Polymer Electrolyte Fuel Cell \(PEFC\)](#)

14:40 to 15:00

Renate Hiesgen (Faculty of Basic Science, University of Applied Sciences, Esslingen, Germany), Tobias Morawietz, Michael Handl, K. Andreas Friedrich

[Structure and Degradation of Fuel Cell Electrodes investigated at High Humidity by Atomic Force Microscopy](#)

15:00 to 15:20

Viktor Hacker (Institute of Chemical Engineering & Environmental Technology, Graz University of Technology, Graz, Austria), Stephan Weinberger, Stephan Trattner

[Dynamic Large Signal Equivalent Circuits for Analysis of Fuel Cell Stack Monitoring Techniques](#)

15:20 to 15:40 INVITED

Simon Thiele (IMTEK Department of Microsystems Engineering, University of Freiburg, Freiburg, Germany)

[From microstructure analysis to novel manufacturing approaches – What questions to answer to achieve the perfect PEFC structure](#)

15:40 to 16:20 KEYNOTE

Jaeyoung Lee (Ertl Center for Electrochemistry and Catalysis, SESE, CHESS, GIST, Gwangju, Korea), Joey D. Ocon, Beomgyun Jeong

[Electrode Architecture in Chemical Energy Conversion and Storage Cells](#)

16:20 to 16:40

Coffee Break

16:40 to 17:00

Luis Castanheira (Electrochemistry, National Physical Laboratory, London, United Kingdom), Ishanka Dedigama, Dan Brett, Nick Van Dijk, Gareth Hinds

[In situ accelerated stress tests for PEM water electrolyser catalysts](#)

17:00 to 17:20 INVITED

Aleksandar Zeradjanin (Helmholtz-Institute Erlangen-Nuremberg for Renewable Energy, Forschungszentrum Jülich, Erlangen-Nuremberg, Germany), Karl J.J. Mayrhofer

[Importance of Advanced Diagnostics in Designing of Active and Stable Oxygen Evolution Electrocatalysts](#)

17:20 to 17:40

Veronica Celorrio (School of Chemistry, University of Bristol, Bristol, United Kingdom), Ellie Dann, Laura Calvillo, Gaetano Granozzi, Ainara Aguadero, Denis Kramer, Andrea Russell, David J. Fermin

[Oxygen Reduction Reaction at \$\text{La}_x\text{Ca}_{\(1-x\)}\text{MnO}_3\$ Nanostructures: Interplay between A-site Segregation and B-site Valence](#)

17:40 to 18:00

Oscar Diaz-Morales (Catalysis and Surface Chemistry, Leiden University, Leiden, Netherlands), Stefan Raaijman, Ruud Kortlever, Patricia J. Kooyman, Tim Wezendonk, Jorge Gascon, W.T. Fu, Marc Koper

[Iridium-based Double Perovskites for Efficient Water Oxidation in Acid Media](#)

18:00 to 18:20

Mario Bärtzsch (Department of Materials, ETH Zurich, Zürich, Switzerland), Renata Solarska, Marta Sarnowska, Olga Krysiak, Jan Augustyński, Markus Niederberger

[Sol-Gel Processed Multicomposite Nanostructured Hematite-Titania Photoanode with Improved Oxygen Evolution: The Role of the Oxygen Evolution Catalyst](#)

18:20 to 18:40

Li Wang (Institute of Engineering Thermodynamics, German Aerospace Center (DLR), Stuttgart, Germany), Viktoriia Saveleva, Spyridon Zafeiratos, Elena Savinova, Philipp Lettenmeier, Pawel Gazdzicki, Aldo S. Gago, K. Andreas Friedrich

[Activity and Degradation Mechanism of Electrochemically Oxidized \$\text{Ir}_x\text{Ru}_{1-x}\text{O}_y\$ Anodes of Proton Exchange Membrane \(PEM\) Electrolyzers](#)

s08 Novel Materials and Devices for Energy Storage: Capacitors

Room : Oceania Foyer

Chaired by: François Béguin and Francesca Soavi

14:00 to 14:20 INVITED

George Zheng Chen (Department of Chemical and Environmental Engineering, University of Nottingham, Nottingham, United Kingdom)

[Asymmetrical Electrochemical Capacitors](#)

14:20 to 14:40 INVITED

Masashi Ishikawa (Department of Chemistry and Materials Engineering, Kansai University, Suita, Japan), Kazunari Soeda, Satoshi Uchida

[Novel Electrochemical Capacitors based on Tailoring Materials to Enhance Power and Energy](#)

14:40 to 15:00 INVITED

Andrea Balducci (Helmholtz Institute Ulm, Karlsruhe Institute of Technology, Ulm, Germany), Christoph Schütter, Jakob Krummacher, Martin Korth

[Nitriles and cyano esters as solvents for high voltage electrochemical double layer capacitors](#)

15:00 to 15:20

Nicolas Jäckel (Energy Materials, INM- Leibniz Institute for New Materials, Saarbrücken, Germany), Marius Rodner, Anna Schreiber, Marco Zeiger, Mesut Aslan, Daniel Weingarth, Volker Presser

[Anomalous or regular capacitance? The influence of pore size dispersity on double-layer formation](#)

15:20 to 15:40

Roberto M. Torresi (Instituto de Química, Universidade de São Paulo, Sao Paulo, Brazil), Jadielson L. Antonio, Susana Cordoba de Torresi

[Three-dimensional conducting polymers films for electrochemical pseudo-capacitors with high-performance energy storage](#)

15:40 to 16:00

Gaëtan Buvat (Institut des Matériaux Jean Rouxel, University of Nantes, Nantes, France), Olivier Crosnier, Nicolas Goubard-Bretesché, Thierry Le Mercier, Thierry Brousse

[Oxygen non-stoichiometric oxides, an approach to design new high volumetric capacitance electrodes for aqueous supercapacitors](#)

16:00 to 16:20

Mara Serrapede (Dipartimento Scienza Applicata e Tecnologia (DISAT), Politecnico di Torino, Torino, Italy), Paola Rivolo, Arnaud Gigot, Marco Fontana, Candido F. Pirri, Elena Tresso

[Graphene-Based Aerogels for Green Supercapacitors](#)

16:20 to 16:40

Coffee Break

16:40 to 17:00

Vitor L. Martins (Chemical and Biological Engineering, University of Sheffield, Sheffield, United Kingdom), Anthony Rennie, Judith Lesowiec, Roberto M. Torresi, Peter Hall

[Increasing EDLC Energy Density Using Polymeric Ionic Liquids as Active Electrode Binders](#)

17:00 to 17:20 INVITED

Francesca Soavi (Department of Chemistry Giacomo Ciamician, Alma Mater Studiorum, University of Bologna, Bologna, Italy)

[Novel Sustainable Materials, Processes and Configurations of Microsupercapacitors](#)

17:20 to 17:40

Guangyue Liao (Institute of Composite Structures and Adaptive Systems, German Aerospace Center (DLR e.V.), Braunschweig, Germany), Qianwen Zou, Sebastian Geier, Thorsten Mahrholz, Peter Wierach, Martin Wiedemann

[Nanostructured all-solid-state supercapacitor based on \$\text{Li}_{1.4}\text{Al}_{0.4}\text{Ti}_{1.6}\(\text{PO}_4\)_3\$ ceramic electrolyte](#)

17:40 to 18:00

Edurne Redondo (Supercapacitors, CIC Energigune, Miñao, Spain), Eider Goikolea, Roman Mysyk[Effect of ion-accessible porosity on the capacitance of activated carbon from olive pit waste](#)

18:00 to 18:20

Hai Yen Tran (Accumulators Materials Research, Zentrum für Sonnenenergie- und Wasserstoff-Forschung (ZSW), Ulm, Germany), Margret Wohlfahrt-Mehrens, Sonia Dsoke[Binder effect on the long term cycling stability of activated carbon based supercapacitors in Li-salt containing electrolytes](#)

18:20 to 18:40

Paulina Babuchowska (Chemical Technology, Poznan University of Technology, Poznan, Poland), François Béguin[Hybrid Capacitors with Quinone Grafted Carbon Electrodes in Salt Aqueous Electrolytes](#)

s11 Electrochemical Engineering for Improvement of Process Sustainability

Room : Europe*Chaired by: Romeu C. Rocha-Filho*

14:00 to 14:40 KEYNOTE

Martin Páidar (Department of Inorganic Technology, University of Chemistry and Technology Prague, Prague, Czech Republic), Jaromir Hnat, Karel Bouzek[Alkaline water electrolysis with ion selective membrane](#)

14:40 to 15:00

Martin Prokop (Department of Inorganic Technology, UCT Prague, Prague, Czech Republic), Tomas Bystron, Martin Páidar, Karel Bouzek, Hector Zamora, Justo Lobato[Oxygen Reduction Reaction Activity of Pt-based Catalysts for High Temperature PEM Fuel Cell Application](#)

15:00 to 15:20

Antoine Allanore (Materials Science and Engineering, Massachusetts Institute of Technology, Cambridge, USA)[Progress on Molten Sulfides Electrolysis: from Electrolyte Design to Electrochemical Engineering](#)

15:20 to 15:40

Vincent Feynerol (Global R&D, ArcelorMittal, Maizières-lès-Metz, France), Hervé Lavelaine, Pascal Marlier, Marie-Noëlle Pons, François Lapicque[Reactivity of Iron Oxides in Low Temperature Alkaline Electrolysis](#)

15:40 to 16:00

Miguel Sandoval (Department of Chemical Engineering, University of Guanajuato, Guanajuato, Mexico), José L. Nava, Rosalba Fuentes[Computational Fluid Dynamic Simulations of Hydrodynamics in a Pre-Pilot Multi-Stack Filter Press Flow Cell](#)

16:00 to 16:20 INVITED

Theo Tzedakis (Chemistry, Chemical Engineering, Univ. Paul Sabatier, Univ. Toulouse, Toulouse, France)[Multiscale electrochemical engineering devoted to valuable products electro synthesis or conversion](#)

16:20 to 16:40

Coffee Break

16:40 to 17:00 INVITED

Thomas Turek (Chemical and Electrochemical Process Engineering, Clausthal University of Technology, Clausthal-Zellerfeld, Germany)[Development of Large-Scale All-Vanadium Redox-Flow Batteries](#)

17:00 to 17:20

Onofrio Scialdone (Dipartimento di Ingegneria Chimica, Gestionale, Informatica, Università di Palermo, Palermo, Italy), Simona Sabatino, Adriana D'Angelo, Fabrizio Vicari, Alessandro Galia, Federica Proietto, Benedetto Schiavo

[Reduction of carbon dioxide to formic acid in various kinds of electrochemical devices](#)

17:20 to 17:40

Elisa Sechi (Ingegneria Meccanica, Chimica e dei Materiali, Università degli Studi di Cagliari, Cagliari, Italy), Michele Mascia

[Preparation of nanotubular Ni through electro deposition of Ni/Cu composites and anodic etching](#)

17:40 to 18:00

Ioanna Kalaitzidou (Chemical Engineering, University of Patras, Patras, Greece), Marialena Makri, Dimitrios Theleritis, Alexandros Katsaounis, Constantinos Vayenas

[Electrochemical promotion of CO₂ hydrogenation on Ru catalysts deposited on Na⁺, K⁺, H⁺ and O₂⁻ conducting solid electrolytes](#)

18:00 to 18:20 INVITED

Paul Kenis (Chemical and Biomolecular Engineering, University of Illinois at Urbana-Champaign, Urbana, USA)

[Electrochemical Reduction of Carbon Dioxide into Value-Added Chemicals](#)

18:20 to 18:40

Tsuyoshi Hoshino (Sector of Fusion Research and Development, Quantum and Radiological Science and Technology (QST), Aomori, Japan)

[Lithium Recovery using Innovative Electrodialysis Method with Lithium Ionic Superconductor for Recycling of Used Li-ion Batteries](#)

s13 Corrosion: The Electrochemistry of Corrosion and Approaches to Corrosion Protection

Room : Amazon

Chaired by: Mary Ryan

14:00 to 14:20

Honorata Kazimierzak (Institute of Metallurgy and Materials Science, Polish Academy of Sciences, Krakow, Poland), Agnieszka Hara, Agnieszka Bigos, Piotr Ozga

[Corrosion resistance of Zn-Mn-Mo coatings electrodeposited on steel](#)

14:20 to 14:40

Viacheslav Shkirskiy (Chimie ParisTech, Institut de Recherche de Chimie Paris, Paris, France), Polina Volovitch, Vincent Vivier

[Delamination mechanisms on Zn in Cl⁻, NH₄⁺ and HCO₃⁻ medias studied by local electrochemical impedance spectroscopy](#)

14:40 to 15:00

Rolandas Verbickas (The European Technical Centre (UK), Daido Metal Co., LTD, Ilminster, United Kingdom), Ignacio Tudela, Mayank Anand, Yi Zhang

[Electrochemical corrosion of metals in lubricant oil](#)

15:00 to 15:20

Jaideep Kulkarni (Research and Development, Shree Rasayani, Nashik, India), Ashish Kulkarni, Donna Arnold

[Structural and Electrochemical Characterisation of Trivalent Chromium-based Conversion Coatings on Electrodeposited Zinc Surfaces](#)

15:20 to 15:40

Helena Otmacic Curkovic (Faculty of Chemical Engineering and Technology, University of Zagreb, Zagreb, Croatia), Ekatarina Kristan Mioc, Zana Hajdari, Marko Plazanic, Predrag Prodanovic

[Corrosion Protection of Cupronickel Alloy by Fatty Acid Film Formed by Various Methods](#)

15:40 to 16:00

Qinghong Fang (School of Materials Science and Engineering, Shenyang University of Chemical Technology, Shenyang, China), Yongsheng Hao

[Inhibiting Mechanism of Phosphate and Ferrate in an Epoxy Coating](#)

16:20 to 16:40

Coffee Break

16:40 to 17:20 KEYNOTE

Sannakaisa Virtanen (Materials Science, Surface Science and Corrosion, WW-4, LKO, University of Erlangen-Nürnberg, Erlangen, Germany)

[Biodegradable Magnesium: Progress in Understanding and Controlling the Corrosion Behaviour in Biological Environments](#)

17:20 to 17:40

Mario Aparicio (Institute of Ceramic and Glass, CSIC, Madrid, Spain), A. Jitianu, G. Rodriguez, A. Degnah, K. Al-Marzoki, Jadra Mosa, L.C. Klein

[Corrosion protection of Magnesium Alloy AZ31B with melting gels coatings: Influence of coating processing and thickness](#)

17:40 to 18:00

Sebastian Feihl (Research & Development, Zahner elektrik GmbH&Co.KG, Kronach, Germany), Carl-Albrecht Schiller, Jörg Vogelsang, Hartmut Ochs, Werner Strunz

[Determination of the Critical-Pigment-Volume Concentration in the Time Domain using Relaxation Voltammetry](#)

18:00 to 18:20

Yan Chen (Laboratory for Corrosion and Protection, Institute of Metal Research, Chinese Academy of Sciences, Shenyang, China), Tao Zhang, Fuhui Wang, Carsten Blawert, Mikhail L. Zheludkevich

[Influence of Second Phase on Corrosion Performance and Formation Mechanism of Anodized Coating on AZ91 Mg Alloy](#)

18:20 to 18:40

Enrico Marsili (Singapore Centre for Environmental Life Sciences Engineering, Nanyang Technological University, Singapore, Singapore), Prasanna Jogdeo, Martin Saballus, Rosalie Chai Mei Yi, Christin Koch, Diane McDougald, Scott A. Rice

[Microbial Influenced Corrosion in Mixed microbial Consortia from Equatorial Environments](#)

s15 New Molecules - Synthesis, Fundamental Electron Transfer Properties and their Relationship with Molecular Action

Room : Everest

Chaired by: Abdelaziz Houmam and R. Daniel Little

14:00 to 14:40 KEYNOTE

Patrick Unwin (Department of Chemistry, University of Warwick, Coventry, United Kingdom)

[Local to Global: New Perspectives on Molecular Electrochemistry at Carbon Electrodes](#)

14:40 to 15:00

Alvaro Colina (Chemistry, Universidad de Burgos, Burgos, Spain), David Ibañez, Jesús Garoz-Ruiz, Aranzazu Heras

[Development of a New Device for Simultaneous UV-Vis Absorption and Raman Spectroelectrochemistry](#)

15:00 to 15:20

Martina Cížková (Département de Chimie, Ecole Normale Supérieure, Paris, France), Laurent Cattiaux, Jean-Maurice Mallet, Christian Amatore, Eric Labbé, Olivier Buriez

[Electrochemical Switching of Fluorescence in Rhodamine Derivatives](#)

15:20 to 15:40

Biprajit Sarkar (Biology, Chemistry and Pharmacy, Free University Berlin, Berlin, Germany), Margarethe van der Meer, David Schweinfurth, Uta Frank

[Effect of the Bridge Symmetry on Electrochemical and Electronic Couplings in Quinonoid Bridged Fe\(II\) and Co\(II\) Complexes](#)

15:40 to 16:00

Xiaowei Li (Department of Chemistry, Hokkaido University, Sapporo, Japan), Takahiro Toda, Hiro Minamimoto, Kei Murakoshi

[Enhanced Photo-Electrochemical Response of Size-Dependent PbS Quantum Dots Excited by Localized Surface Plasmon Resonance](#)

16:00 to 16:20

Alan Liska (Department of Inorganic Chemistry, Charles University in Prague, Faculty of Science, Prague, Czech Republic), Jirí Ludvík, Pavel Vojtisek

[Calix\[4\]arene tetradical tetraanion – an electrochemically generated ligand](#)

16:20 to 16:40

Coffee Break

16:40 to 17:20 KEYNOTE

Andrew Doherty (Chemistry and Chemical Engineering, The Queen's University of Belfast, Belfast, United Kingdom), Louise Graham

[Redox-active Ionic Liquids. Synthesis, Electrochemistry, and Applications in Sensing, Energy Harvesting and Energy Storage](#)

17:20 to 17:40

Mauricio Isaacs (Departamento de Química Inorgánica, Pontificia Universidad Católica de Chile, Santiago, Chile)

[Task Specific Ferrocenyl-Ionic Liquids in Carbon Paste Microelectrodes for Dopamine Electro-Analysis](#)

17:40 to 18:00

Abdirisak A. Isse (Department of Chemical Sciences, University of Padova, Padova, Italy), Francesca Lorandi, Marco Fantin, Armando Gennaro

[Electrochemical Characterization of Catalysts and Initiators for ATRP in \[BMIm\]\[OTf\]](#)

18:00 to 18:20

Haidong Li (Institute of Molecular Science, University of Bordeaux, Bordeaux, France)

[Efficient Electrochemiluminescence from Cationic Helicene Dyes: Switch from Organic Solvent to Bright Aqueous Systems](#)

18:20 to 18:40

Ismael Díez-Pérez (Physical Chemistry, University of Barcelona, Barcelona, Spain)

[Studying Chemical Reactions at the Nanoscale](#)

s16 Physical and Interfacial Electrochemistry: Progress in Spectroscopy, Imaging and Theoretical Analysis

Room : Kilimanjaro

Chaired by: Elisabet Ahlberg and Kei Murakoshi

14:00 to 14:20

Juan Miguel Feliu Martinez (Institute of Electrochemistry, University of Alicante, Alicante, Spain), Paula Sebastian Pascual, Ricardo Martinez Hincapie, Victor Climent Paya, Antonio Berna Galiano, Antonio Rodes Garcia

[Charge dependence of interfacial acid-base properties at Pt\(111\)/non-adsorbing supporting electrolytes](#)

14:20 to 14:40

Daniel Hanß (Institute of Energy and Climate Research, Forschungszentrum Juelich GmbH, Juelich, Germany), Izaak C. Vinke, L.G.J. de Haart, Ruediger-A. Eichel

[Application of an alternative Impedance Model for \$\text{LiNi}_{0.5}\text{Mn}_{1.5}\text{O}_4\$ in Lithium Ion Batteries](#)

14:40 to 15:00

Ludwig Kibler (Institut für Elektrochemie, Universität Ulm, Ulm, Germany), Johannes Hermann, Timo Jacob

[Studies of dynamic surface processes on electrode surfaces by measuring electrocatalytic activities](#)

15:00 to 15:20

Maria Escudero-Escribano (Department of Physics, Technical University of Denmark, Kongens Lyngby, Denmark), Paolo Malacrida, Martin H. Hansen, Ulrik Grønbjerg, Amado Velazquez-Palenzuela, Vladimir Tripkovic, Jakob Schiøtz, Jan Rossmeisl, Ifan Stephens, Ib Chorkendorff

[Tuning the Electrocatalytic Activity, Stability and Reactivity of Pt Alloys by Means of the Lanthanide Contraction](#)

15:20 to 15:40

Dejun Chen (Department of Chemistry, Georgetown University, Washington, USA), YuYe Tong

[New Mechanistic Insights on Methanol and Formic Acid Electro-oxidation as Investigated by In-situ Surface Enhanced Infrared Adsorption Spectroscopy](#)

15:40 to 16:00

Amanda Cristina Garcia (Chemistry Department, São Carlos Chemistry Institute, São Carlos, Brazil), Manuel Kolb, Chris Nierop y Sanchez, Jan Vos, Yuvraj Y. Birdja, Youngkook Kwon, Germano Tremiliosi-Filho, Marc Koper

[Strong impact of platinum surface structure on the selectivity of glycerol electro-oxidation](#)

16:00 to 16:20

Thomas Doneux (Chimie Analytique et Chimie des Interfaces, Université Libre de Bruxelles, Bruxelles, Belgium), Laurent Bouffier, Bertrand Goudeau, Stéphane Arbault

[Electrochemically Coupled Fluorescence Microscopy for the Study of Interfacial Reactivity Processes](#)

16:20 to 16:40

Coffee Break

16:40 to 17:20 KEYNOTE

Andrew Gewirth (Chemistry, University of Illinois, Urbana, USA), Christopher Barile, Edmund Tse, Thao Hoang, Jason Varnell

[Controlling the OER and ORR with Proton Kinetics](#)

17:20 to 17:40

Guy Denuault (Chemistry, University of Southampton, Southampton, United Kingdom), Oliver Rodriguez-Martinez, Samuel C. Perry

[The Oxygen Reduction Reaction on Reduced Metals: Evidence for a Unique Relationship Between the Coverage of Adsorbed Oxygen Species and their Adsorption Energy](#)

17:40 to 18:00

Yan-Xia Chen (Department of Chemical Physics, University of Science and Technology of China, Hefei, China), Yong-Li Zheng, Jie Wei

[Activity versus Stability, Oxygen Reduction at \$\text{Pt}\[n\(111\)\times 111\]\$ and \$\text{Ir}\[n\(111\)\times 111\]\$ Electrodes in Acidic Media](#)

18:00 to 18:20

Enrique Herrero (Instituto de Electroquímica, Universidad de Alicante, Alicante, Spain), Valentín Briega-Martos, Juan Miguel Feliu Martínez

[Effect of the Interfacial Properties on the Oxygen Reduction Reaction on Platinum Electrodes](#)

18:20 to 18:40

Kohei Uosaki (Global Research Center for Environment and Energy based on Nanomaterials Science, National Institute for Materials Science, Tsukuba, Japan), Ganesan Elumalai, Hung Cuong Dinh, Hidenori Noguchi, Andrey Lyalin, Tetsuya Taketsugu

[Theoretical and Experimental Investigations on the Effect of Gold Nanoparticle Decoration of BN Nanosheet on Gold for Highly Efficient Electrocatalyst for Oxygen Reduction Reaction](#)

s17 Attention: Theory Only

Room : Yangtze 2

Chaired by: Federico Calle-Vallejo and Priyamvada Goyal

14:00 to 14:20

Jan Rossmeisl (Department of Chemistry, University of Copenhagen, Copenhagen, Denmark)

[Modeling the Electrochemical Interface](#)

14:20 to 14:40

Minoru Otani (Research Centre for Computational Design of Advanced Functional Materials, National Institute of Advanced Industrial Science and Technology, Tsukuba, Japan)

[First-Principles Simulation of Electrochemical Reactions at Solid/Liquid Interface: From a Microscopic Analysis to the Current-Voltage Characteristic Curve](#)

14:40 to 15:00

Jean-Sébastien Filhol (Chemistry, CTMM, ICGM/Université de Montpellier, Montpellier, France), Nicolas Lespes

[Modeling Electrochemical Processes at the Solvent-Electrode Interface](#)

15:00 to 15:20

Ryosuke Jinnouchi (Smart Material Design Division, Toyota Central R&D Labs., Inc., Nagakute, Japan), Kensaku Kodama, Yu Morimoto

[DFT Calculations on Electrified Interfaces: Electrosorption Valency Value and Symmetry Factor](#)

15:20 to 15:40

Eckhard Spohr (Department of Chemistry, University Duisburg-Essen, Essen, Germany)

[Proton Transport through Aqueous Electrolyte Solutions to Charged Metal Electrodes and Electrochemical Discharge](#)

15:40 to 16:00

Heine Hansen (Department of Energy Conversion and Storage, Technical University of Denmark, Kgs. Lyngby, Denmark), Mateusz Reda, Tejs Vegge

[Oxygen Reduction Activity on Graphite Encapsulated Catalysts](#)

16:00 to 16:20

Fritz Scholz (Institut für Biochemie, Universität Greifswald, Greifswald, Germany)

[On the Thermodynamics of Insertion Electrochemical Systems](#)

16:20 to 16:40

Coffee Break

Chaired by: *Jan Rossmeisl and Fritz Scholz*

16:40 to 17:20 KEYNOTE

ALEXANDER KUZNETSOV PRIZE FOR THEORETICAL ELECTROCHEMISTRY

Martin Z. Bazant (Chemical Engineering and Mathematics, Massachusetts Institute of Technology, Cambridge, USA)

[Theory of Electrochemical Interfaces at High Voltage](#)

17:20 to 17:40

Andrei Kulikovskiy (Institute of Energy and Climate Research, IEK-3, Research Centre Juelich, Juelich, Germany)

[Analytical Tools for Deciphering PEM Fuel Cell Impedance Spectra](#)

17:40 to 18:00

Hartmut Löwen (Institut für Theoretische Physik II: Weiche Materie, Heinrich-Heine Universität Düsseldorf, Düsseldorf, Germany), Elshad Allahyarov, Lei Zhu

[Actuation of Lattice Nanocomposites with Polarizable Inclusions by an Electric Field](#)

18:00 to 18:20

Douwe Jan Bonthuis (Rudolf Peierls Centre for Theoretical Physics, Oxford University, Oxford, United Kingdom)

[Ions at interfaces: Combining molecular dynamics simulations and continuum theory](#)

18:20 to 18:40

Juan Maria Garcia Lastra (Department of Energy Conversion and Storage, Technical University of Denmark, Kongens Lyngby, Denmark), Tejs Vegge, Rune Christensen, Yedilfana Mekonnen, Nicolai Mathiesen, Marko Melander, Simon Loftager

[Modeling of transport phenomena in battery cathode materials](#)

Tuesday, 23 August 2016

ROOMS:	Mississippi	Yangtze 1	Oceania	King Willem Alexander	Oceania Foyer	Europe	Amazon	Everest	Kilimanjaro	Yangtze 2	
SYMPOSIUM	Symposium 1	Symposium 3	Symposium 6	Symposium 7	Symposium 8	Symposium 11	Symposium 13	Symposium 15	Symposium 16	Symposium 9	
08:15 - 09:15	Plenary Lecture: Linda F. Nazar (King Willem Alexander)										
09:30 - 09:50	Lucio Angnes	Lars Jeuken	Maria Forsyth	Serhiy Cherevko	John R. Miller	Edward Roberts	Vincent Vivier	Abdelaziz Houmam	YuYe Tong	Juan Santiago	
09:50 - 10:10	A. Gamaro Quijano	Ross Milton		S. Berthon-Fabry			Beatriz Valcaroe		G. Tremiliosi-Filho		
10:10 - 10:30	Salvatore Daniele	Felipe Conzuelo	Andreas Bildberg	Denis Kramer	Wataru Sugimoto	Tomas Bystrom	Masayuki Itagaki	Frederic Gloaguen	Evangelina Pensa	Peng Liang	
10:30 - 10:50	Gaston Crespo	Leonard Stoica	Hyuk Jae Kwon	Alessandro Zana	Minglong He	Javier Llanos	Tobias Balhoff	Marilia Goullart	Katharina Krischer	Ran Zhao	
10:50 - 11:10	Coffee Break &										
11:10 - 11:30	POSTER SESSION 2 (s3, s4, s7, s10)										
11:30 - 11:50											
11:50 - 12:10											
12:10 - 12:30											
12:40 - 13:40	Lunch			Council Meeting				Lunch			
14:00 - 14:20	Symposium 1	Symposium 3	Symposium 6	Symposium 7	Symposium 8	Symposium 11	Symposium 13	Symposium 14	Symposium 16	Symposium 9	
14:20 - 14:40	Bryan McCloskey	Itamar Willner	Diana Golodnitsky	Anna K. Schuppert	Chi-Chang Hu	R.C. Rocha-Filho	Shinji Fujimoto	Jan Franseer	Sylvain Brimaud	Bert Hamelers	
14:40 - 15:00	Shibabrata Basak	Nicolas Plumeré	Robert Kostecki	Piotr Zelenay	Thierry Brousse	Jan-Chris. Wiencke	Jan P. Kollender	Olaf Magnussen	F. Calle-Vallejo		
15:00 - 15:20	Fabio Masiello	Paul Kavanagh	Yongyao Xia	Qingfeng Li	Agnieszka Brzózka	K. Groen. Serrano	Barbara Laurent	Jon Ustarroz	Anna Wuttig	Chad Vecitis	
15:20 - 15:40	Gunther Wittstock	Plamen Atanassov	Hatem M.A. Amin	Daniel Malko	Krzysztof Fic	C. A. Martin.-Huitle	Ying Li	Elisabet Ahlberg	Karen Chan	Youri Gendel	
15:40 - 16:00	Jesus Garoz-Ruiz	W. Schuhmann	Klemen Pirnat	Ioanna Martinaiou	Juhan Lee	Ricardo Salazar	Herman Terry	Meng Nan Chong	Elisabet Ahlberg	Piotr Dlugolecki	
16:00 - 16:20	Aranzazu Heras	Seiya Tsujimura	Yang-Kook Sun	Ken Sakaushi	Christian Koczvara	Tzayam Pérez	Bernard Tribollet	Elizabeth Oseland	Stefan Ringe	Chia-Hung Hou	
16:20 - 16:40	Coffee Break										
16:40 - 17:00	Maria Cuartero	Bernhard Wolfrum	Alejandro A. Franco	Peter Strasser	M. Sku.-Nuckowska	Clément Trelu	Monica Santamaria	Laxmidhar Besta	Philip Bartlett	Volker Presser	
17:00 - 17:20	Neso Sojic	David Pery	Marco Doeff	E. Zamburlini	Heejoon Ahn	Elisama Santos	David Holuscha	Claudine Filiatre	Katrin F. Domke	Xin Gao	
17:20 - 17:40	Lane Baker	Alexander Olenick	Christoph Vaalima	Laettia Dubau	Vladislav Ivanistsev	Henry Bergmann	Sviatl. V. Lamaka	Cécéric Frantz	Andrew Wain	Jianyun Liu	
17:40 - 18:00	Christa Brosseau	J. Juhaniewicz	Yoji Sakurai	Juan Herranz	Yuqing Liu	Erika Bustos	D. Vjajshankar	Rosalina Pérez	Nagahiro Hoshi	Yu-Hsuan Liu	
18:00 - 18:20	Javier Izquierdo	Marc Riedel	Aurélie Guéguen	Isaac Adjei Safo	Evgeny Senokos	Minghua Zhou	Yang Yu	Begona Ferrari	Kei Murakoshi	Matthew Suss	
18:20 - 18:40	Georg Papastavrou	Anne de Poulpique	Liujing Yang		Kumar Raju	Audrey Iranzo	B. Fernand-Perez				
18:40 - 20:00	Reception										

Tuesday 23 August 2016, Morning

Plenary Lecture

Room : King Willem Alexander

Chaired by: Stefano Passerini

08:15 to 09:15

Linda F. Nazar (Department of Chemistry and Waterloo Institute for Nanotechnology, University of Waterloo, Waterloo, Canada)

[New Vistas in Electrochemical Energy Storage](#)

s01 New Horizons in Analytical Electrochemistry

Room : Mississippi

Chaired by: Priscilla Baker

09:30 to 09:50 INVITED

Lucio Angnes (Departamento de Química Fundamental, Universidade de São Paulo, São Paulo, Brazil)

[Modified Electrodes: The Starting of an Endless Frontier?](#)

09:50 to 10:10

Alonso Gamero Quijano (LCPME, Université de Lorraine, Nancy, France), Lukasz Poltorak, Gregoire Herzog, Alain Walcarius

[Ion Stripping Voltammetry at liquid/liquid interfaces modified with electrogenerated mesoporous silica](#)

10:10 to 10:30

Salvatore Daniele (Department of Molecular Sciences and Nanosystems, University Cà Foscari Venice, Venice, Italy), Gregorio Bonazza, Nicolò Gasparetto, Carlo Bragato

[Pseudopolarography of Aqueous Suspensions of Silver Nanoparticles Using a Platinum Microelectrode](#)

10:30 to 10:50

Gaston Crespo (Inorganic and Analytical Chemistry, University of Geneva, Geneva, Switzerland)

[Novel Electrochemical Concepts for In-situ Environmental Measurements](#)

10:50 to 11:10

Coffee Break

s03 New Approaches for Interfacing Electrochemistry and Biological Systems

Room : Yangtze 1

Chaired by: *Lars Jeuken and Stanislav Trashin*

09:30 to 09:50 INVITED

Lars Jeuken (School of Biomedical Sciences, University of Leeds, Leeds, United Kingdom), Ee Taek Hwang, Khizar Sheikh, Katherine Orchard, Daisuke Hojo, Valentin Radu, Chong-Yong Lee, Emma Ainsworth, Colin Lockwood, Manuela Gross, Tadafumi Adschiri, Erwin Reisner, Julea Butt

[Mimicing Photosystems: Decaheme Cytochromes as Molecular Electron Conduits in Semiconductor Nanoparticle Photoanodes](#)

09:50 to 10:10

Ross Milton (Departments of Chemistry and Mechanical Engineering, University of Utah, Salt Lake City, USA), Sofiene Abdellaoui, Donal Leech, Shelley Minter

[Heterogeneous Bioelectrochemistry of Nitrogenase](#)

10:10 to 10:30

Felipe Conzuelo (Analytical Chemistry, Center for Electrochemical Sciences, Ruhr-Universität Bochum, Bochum, Germany), Vera Eßmann, Fangyuan Zhao, Adrian Ruff, Volker Hartmann, Marc M. Nowaczyk, Matthias Rögner, Wolfgang Schuhmann

[Coupling of PS1 and PS2 Protein Complexes Integrated in Redox Polymer-Modified Bioelectrodes for Artificial Photosynthesis Driven by Bipolar Electrochemistry](#)

10:30 to 10:50

Leonard Stoica (Department of Food Science and Technology, University of Natural Resources and Life Sciences, Vienna, Austria)

[Electrochemical Evidences on Rational Design of Oxygen-Reactivity at Pyranose 2-Oxidase based on Site-Saturation Mutagenesis](#)

10:50 to 11:10

Coffee Break

s06 Novel Materials and Devices for Energy Storage: Batteries for Tomorrow's World

Room : Oceania

Chaired by: *Dominic Bresser and Maria Forsyth*

09:30 to 10:10 KEYNOTE

Maria Forsyth (Institute for Frontier Materials, Deakin University Burwood Camps, Burwood, Australia), Patrick Howlett, Douglas MacFarlane, Matthias Hilder, Fangfang Chen, Faezeh Makhlooghiazad

[Mixed salt electrolytes for Sodium battery applications](#)

10:10 to 10:30

Andreas Blidberg (Dept. of Chemistry - Ångström Laboratory, Uppsala University, Uppsala, Sweden), Adam Sobkowiak, Carl Tengstedt, Torbjörn Gustafsson, Fredrik Björefors

[Electrochemical Performance of PEDOT Coated LiFeSO₄F Electrodes](#)

10:30 to 10:50

Hyuk Jae Kwon (Energy Lab, SAIT, Samsung Electronics, Suwon-si, Korea), Jeongsik Ko, Heung Chan Lee, Dongmin Im, Seok-Gwang Doo

[The Effect of Oxygen Partial Pressure on Li-Air Battery Performances: Capacity and Cycle Life](#)

10:50 to 11:10

Coffee Break

s07 Novel Materials and Devices for Energy Conversion and Storage: Fuel Cells, Electrolysers, Regenerative Fuel Cells and Flow Batteries

Room : King Willem Alexander

Chaired by: Peter Strasser

09:30 to 09:50

Serhiy Cherevko (Helmholtz-Institute Erlangen-Nuremberg for Renewable Energy, Forschungszentrum Jülich, Erlangen, Germany), Simon Geiger, George Polymeros, Gareth P. Keeley, Olga Kasian, Jan-Philipp Grote, Nadiia Kulyk, Karl J. J. Mayrhofer

[In-situ Analysis of Electrochemical Degradation Processes in Printed Pt/C Catalyst Layers](#)

09:50 to 10:10

Sandrine Berthon-Fabry (PERSEE, Mines ParisTech, Sophia Antipolis, France), Fabien Labbé, Rudolf Metkemeijer, Yasser Ahmad, Nicolas Batisse, Marc Dubois, Katia Guérin, Belen Molina Concha, Frédéric Maillard, Laetitia Dubau, Raphael Chattot, Marian Chatenet

[Durability of carbon supports for PEMFC application. Influence of the degree of graphitization and effect of fluorination](#)

10:10 to 10:30 INVITED

Denis Kramer (Engineering Sciences, University of Southampton, Southampton, United Kingdom), Colleen Jackson, Graham T. Smith, Andrea Russell, Pieter B. J. Levecque

[Oxygen Reduction Activity and Durability of Nanoparticulate Pt Supported on Boron and Silicon Carbides](#)

10:30 to 10:50

Alessandro Zana (Chemistry, University of Copenhagen, Copenhagen, Denmark), Matthias Arenz

[Carbon corrosion on PEMFC catalysts: From commercial Carbon blacks to Graphitized carbon blacks](#)

10:50 to 11:10

Coffee Break

s08 Novel Materials and Devices for Energy Storage: Capacitors

Room : Oceania Foyer

Chaired by: Chi-Chang Hu

09:30 to 10:10 KEYNOTE

John R. Miller (JME, Inc. and Case Western Reserve University, Beachwood, USA), Sue M. Butler

[Electrochemical Capacitor Design Optimization](#)

10:10 to 10:30

Wataru Sugimoto (Faculty of Textile Science and Technology, Shinshu University, Ueda, Japan)

[High Surface Area “Non-activated” Reduced Graphite Oxide](#)

10:30 to 10:50

Minglong He (Electrochemical Energy Storage Section, Paul Scherrer Institut, Villigen PSI, Switzerland), Krzysztof Fic, Elzbieta Frackowiak, Petr Novák, Erik J. Berg

[Ageing Phenomena in High-voltage Aqueous Supercapacitors Investigated by In Situ Gas Analysis](#)

10:50 to 11:10

Coffee Break

s09 Capacitive Electrodes for Environmental Technology

Room : Yangtze 2

Chaired by: *Matthew Suss*

09:30 to 10:10 KEYNOTE

Juan Santiago (Mechanical Engineering Department, Stanford University, Stanford, USA), Ali Hemmatifar, Yatian Qu, James Palko, Michael Stadermann

[Energy Loss Mechanisms in Capacitive Deionization](#)

10:10 to 10:30 INVITED

Peng Liang (School of Environment, Tsinghua University, Beijing, China), Yanhong Bian, Xia Huang

[Capacitive Separator for Enhanced Desalination Performance of Membrane Capacitive Deionization](#)

10:30 to 10:50

Ran Zhao (School of Physics and Materials, East China Normal University, Shanghai, China), Miao Wang, Likun Pan

[Capacitive neutralization deionization with flow electrodes](#)

10:50 to 11:10

Coffee Break

s11 Electrochemical Engineering for Improvement of Process Sustainability

Room : Europe

Chaired by: *Ann Cornell*

09:30 to 10:10 KEYNOTE

Edward Roberts (Department of Chemical & Petroleum Engineering, University of Calgary, Calgary, Canada)

[Electrochemical Treatment of Industrial Waste Water: Challenges and Opportunities](#)

10:10 to 10:30

Tomas Bystron (Department of Inorganic Technology, University of Chemistry and Technology Prague, Prague 6, Czech Republic), Jakub Polonsky, Martin Paidar, Martin Vesely, Karel Bouzek

[Anodic Ti passivation in the operating PEM water electrolyser](#)

10:30 to 10:50

Javier Llanos (Department of Chemical Engineering, University of Castilla-la Mancha, Ciudad Real, Spain), Martin Muñoz, Salvador Cotillas, Manuel A. Rodrigo, Pablo Cañizares

[Development of Electrocoagulation Processes for the Removal of Pesticides](#)

10:50 to 11:10

Coffee Break

s13 Corrosion: The Electrochemistry of Corrosion and Approaches to Corrosion Protection

Room : Amazon

Chaired by: Wouter Hamer

09:30 to 09:50

Vincent Vivier (LISE, UPMC - CNRS, Paris, France), Stéphane Heurtault, Suzanne Joiret, Raphael Robin, Fabien Rouillard

[Pitting corrosion on 316L stainless steel investigated through single event experiment](#)

09:50 to 10:10

Beatriz Valcarce (Division Corrosion y Electroquímica, INTEMA, UNMDP, Mar del Plata, Argentina)

[Correlation between donor density and inhibition efficiency by phosphate and nitrite ions on carbon steel](#)

10:10 to 10:30

Masayuki Itagaki (Department of Pure and Applied Chemistry, Tokyo University of Science, Noda, Japan), Taisuke Koike, Masanori Soukura, Tatsuki Okamoto, Hiroyuki Tokieda, Yoshinao Hoshi, Isao Shitanda, Yoshitaka Kato

[EIS to Investigate Concrete Degradation and Rebar Corrosion](#)

10:30 to 10:50

Tobias Baldhoff (Department of Chemical and Process Engineering, University of Canterbury, Christchurch, New Zealand), Aaron Marshall

[Study of Anodically Formed Solid Films during Electropolishing of Aluminium using Electrochemical Impedance Spectroscopy](#)

10:50 to 11:10

Coffee Break

s15 New Molecules - Synthesis, Fundamental Electron Transfer Properties and their Relationship with Molecular Action

Room : Everest

Chaired by: Andrew Doherty

09:30 to 10:10 KEYNOTE

Abdelaziz Houmam (Department of Chemistry, University of Guelph, Guelph, Canada), Kallum M. Koczur, Emad M. Hamed, Colin R. Hesp, Hamida Muhammad, Hanh Doai, Chang Ji

[Electrochemical Investigation of Various Organosulfur Compounds: Fundamental and Practical Aspects](#)

10:10 to 10:30 INVITED

Frederic Gloaguen (UMR 6521, CNRS, Université de Bretagne Occidentale, Brest, France)

[Catalysis of H₂ Production by Iron-Thiolate Complexes: an Electrochemical and Computational Study](#)

10:30 to 10:50

Marilia Goulart (Instituto de Química e Biotecnologia, Universidade Federal de Alagoas, Maceio, Brazil), Thaissa Lucio Silva, André Felipe Xavier, Camila C. de Vasconcelos, Rosanny C. Silva, Fabricia R. Ferreira, Paulo R. Costa, Chaquip D. Netto

[ROS Release and Alkylating Ability of Pterocarpanquinones: Electrochemistry meets Medicinal Chemistry](#)

10:50 to 11:10

Coffee Break

s16 Physical and Interfacial Electrochemistry:
Progress in Spectroscopy, Imaging and Theoretical Analysis

Room : Kilimanjaro

Chaired by: Andrew Gewirth

09:30 to 09:50

YuYe Tong (Department of Chemistry, Georgetown University, Washington, USA), Eric G. Sorte, Dejun Chen
[New in situ Methods for Fuel Cells and Batteries: Dual-Electrode IR Spectroscopy and Stripline NMR spectroscopy](#)

09:50 to 10:10

Germano Tremiliosi-Filho (Department of Physical Chemistry, Institute of Chemistry of Sao Carlos, University of Sao Paulo, Sao Carlos, Brazil), Nyccolas Emanuel de Souza, Janaina Fernandes Gomes
[Reactivity of Alcohols with 3-Carbon-Atom Chain on Gold Electrode in Different Electrochemical Environments](#)

10:10 to 10:30

Evangelina Pensa (Chemistry, Imperial College London, London, United Kingdom), Tim Albrecht
[Small Au Nanoparticles and their Interaction with Metallic Surfaces](#)

10:30 to 10:50 INVITED

Katharina Krischer (Physik-Department, Technische Universität München, Garching, Germany), Konrad Schönleber, Maximilian Patzauer
[Spatio-temporal in-situ study of dynamic phenomena during Si electrodisolution by means of ellipsometric imaging](#)

10:50 to 11:10

Coffee Break

Tuesday, 23 August 2016, Afternoon

s01 New Horizons in Analytical Electrochemistry

Room : Mississippi

Chaired by: Lane Baker and Fethi Bedioui

14:00 to 14:40 KEYNOTE

Early Career Analytical Electrochemistry Prize of ISE Division 1

Bryan McCloskey (Chemical and Biomolecular Engineering, University of California, Berkeley, USA)

[Ion Solvation Effects in the Nonaqueous Li-O₂ Electrochemistry](#)

14:40 to 15:00

Shibabrata Basak (Quantum Nanosciences, Delft, Netherlands), Sairam Krishna Malladi, Deepak Pratap Singh, Henny Zandbergen

[In-situ TEM investigation on high performance Lithium-ion battery materials](#)

15:00 to 15:20

Fabio Masiello (Product Marketing XRD, PANalytical B.V., Almelo, Netherlands), Gwilherm Nénert, Marco Sommariva, Martijn Fransen, Milen Gateshki, Stjepan Prugovecki, Stefan Seidlmayer

[Using X-ray diffraction and imaging for the investigation of battery materials: from bulk structural characterization to in situ and in operando measurements](#)

15:20 to 15:40

Gunther Wittstock (Institute of Chemistry, Carl von Ossietzky University of Oldenburg, Oldenburg, Germany), Saustin Dongmo, Patrick Schwager, Daniela Fenske

[Formation and detection of reactive oxygen species in SECM configurations](#)

15:40 to 16:00

Jesús Garoz-Ruiz (Department of Chemistry, Universidad de Burgos, Burgos, Spain), Aranzazu Heras, Alvaro Colina

[Direct Measurement of Ascorbic Acid in Fruits: Expanding the Horizons of Spectroelectrochemistry](#)

16:00 to 16:20

Aranzazu Heras (Department of Chemistry, Universidad de Burgos, Burgos, Spain), Alvaro Colina, Noelia González-Diequez, Jesús Garoz-Ruiz, Daniel Izquierdo, Carlos Guillen, Joaquin Barrera

[Time-Resolved UV/Vis Absorption Spectroelectrochemistry: A Trilinear Technique for Quantitative Analysis](#)

16:20 to 16:40

Coffee Break

16:40 to 17:00

Maria Cuartero (Department of Inorganic and Analytical Chemistry, University of Geneva, Geneva, Switzerland), Gaston Crespo, Eric Bakker

[Thin Layer Membranes for Multi-Analyte Detection](#)

17:00 to 17:20

Neso Sojic (ISM, University of Bordeaux, Pessac, France), Haidong Li, Adam C. Sedgwick, Stephane Arbault, Tony D. James

[Novel Electrochemiluminescent Strategy for Selective Saccharide Detection Based on Boronic Acid Recognition](#)

17:20 to 17:40 INVITED

Lane Baker (Chemistry, Indiana University, Bloomington, USA)

[Scanning Electrospray Microscopy: A new mode of electrochemical imaging](#)

17:40 to 18:00

Christa Brosseau (Chemistry, Saint Mary's University, Halifax, Canada), Lili Zhao, Reem Karaballi, Scott Harroun

[Plasmon-Enhanced Spectroelectrochemistry - An Advanced Tool for Point-of-Care Diagnostics](#)

18:00 to 18:20

Javier Izquierdo (Institute of Analytical and Bioanalytical Chemistry, University of Ulm, Ulm, Germany), Boris Mizaikoff, Christine Kranz

[Spectroelectrochemistry in the mid-IR region at modified boron-doped diamond surfaces](#)

18:20 to 18:40

Georg Papastavrou (Physical Chemistry II, University of Bayreuth, Bayreuth, Germany), Andreas Mark, Sebastian Gödrich, Christian Stelliling, Hartmut Stadler, Markus Retsch, Zhuangqun Huang

[Simultaneous Nano-Electrochemical and Topographical Imaging of Au-Nanomesh Electrodes and Micro-Contact Printed Self-Assembled Thiol-Monolayers](#)

TUESDAY PM

s03 New Approaches for Interfacing Electrochemistry and Biological Systems

Room : Yangtze 1

Chaired by: Fred Lisdat and Olga Swiech

14:00 to 14:40 KEYNOTE

Itamar Willner (Institute of Chemistry, The Hebrew University of Jerusalem, Jerusalem, Israel)

[Electrical Contacting of Redox Proteins with Electrodes. A Basic Paradigm for Development of Biosensors, Fuel Cells and Photobioelectrochemical Cells](#)

14:40 to 15:00

Nicolas Plumeré (Center for Electrochemical Sciences, Ruhr-Universität Bochum, Bochum, Germany), Stefanie Stapf, Darren Buesen, Huaiguang Li, Adrian Ruff, Felipe Conzuelo, Alaa Oughli, Olaf Rüdiger, Martin Winkler, Vincent Fourmond, Christophe Léger, Thomas Happe, Wolfgang Lubitz, Wolfgang Schuhmann

[Redox Hydrogels as Protection Matrices for Redox Biocatalysts](#)

15:00 to 15:20

Paul Kavanagh (School of Chemistry, National University of Ireland, Galway, Galway, Ireland), Peter OConghaile, Donal Leech, Michelle Coote

[Rational Design of Electron Mediators for Use in Enzymatic Fuel Cells: Towards High Current at Low Overpotentials](#)

15:20 to 15:40 INVITED

Plamen Atanassov (Chemical and Biological Engineering Department, University of New Mexico, Albuquerque, USA), Ivana Matanovic, Sofia Babanova

[Rational Design of Electrodes for Biofuel Cells and Biosensors](#)

15:40 to 16:00

Wolfgang Schuhmann (Analytical Chemistry, Center for Electrochemical Sciences, Ruhr-Universität Bochum, Bochum, Germany)

[Electrocatalysis and bioelectrocatalysis - distinction without a difference](#)

16:00 to 16:20

Seiya Tsujimura (Division of Materials Science, Faculty of Pure and Applied Sciences, University of Tsukuba, Tsukuba, Japan), Ayumu Niiyama

[Glucose/O₂ enzymatic biofuel cell based on MgO-templated porous carbon](#)

16:20 to 16:40

Coffee Break

16:40 to 17:00 INVITED

Bernhard Wolfrum (Department of Electrical and Computer Engineering, Technical University of Munich, Garching, Germany), Philipp Rinklin, Truong Ka My Dang, Nouran Adly, Bernd Bachmann, Alexey Yakushenko, Jan Schnitker, Kay J. Krause

[Sensor Arrays for Probing Defined Cell-Network Configurations](#)

17:00 to 17:20

David Perry (Department of Chemistry, University of Warwick, Coventry, United Kingdom), Dmitry Momotenko, Binoy Paulose Nadappuram, Patrick Unwin

[Electrochemical Mapping of the Surface Charge of Living Cells](#)

17:20 to 17:40

Alexander Oleinick (Department of Chemistry, CNRS UMR 8640 'PASTEUR', Ecole Normale Supérieure, Paris, France), Irina Svir, Christian Amatore

[Theoretical Extraction of Fusion Nanopores Topology from Amperometric Measurements of Vesicular Exocytosis at Chromaffin Cells and Neuromuscular Junctions](#)

17:40 to 18:00

Joanna Juhaniwicz (Faculty of Chemistry, University of Warsaw, Warsaw, Poland), Slawomir Sek

[Interactions of lipopeptides with different optical activity with model lipid membranes](#)

18:00 to 18:20

Marc Riedel (Biosystems Technology, Institute of Applied Life Sciences, Technical University of Applied Sciences Wildau, Wildau, Germany), Sara Lippert, Martin Eickhoff, Wolfgang J. Parak, Fred Lisdat

[Light-triggered bioanalysis based on semiconductor nanostructures](#)

18:20 to 18:40

Anne de Poulpiquet (Institute of Molecular Sciences, CNRS, University of Bordeaux, Pessac, France), Beatriz Diez-Buitrago, Milena Milutinovic, Laurent Bouffier, Stephane Arbault, Alexander Kuhn, Neso Sojic

[Enzymatic detection by three-dimensional bipolar electrochemiluminescence](#)

s06 Novel Materials and Devices for Energy Storage: Batteries for Tomorrow's World

Room : Oceania

Chaired by: Marca Doeff and Marnix Wagemaker

14:00 to 14:20

Diana Golodnitsky (School of Chemistry, Tel Aviv University, Tel Aviv, Israel), Raymond Blanga, Meital Goor, Inna Schektman, Tzah Mukra, Emanuel Peled

[Concerning the all-solid-state Li/S battery](#)

14:20 to 14:40

Robert Kostecki (ESDR, LBNL, Berkeley, USA), V. Battaglia, G. Chen, W. Chen, G. Liu, D. Membreno, K. Persson, A. Shukla, L. Terborg, T. Yi

[The Mechanism of the Impedance Increase in HCMRTM Cathodes](#)

14:40 to 15:00

Yongyao Xia (Department of Chemistry, Fudan University, Shanghai, China)

[To Improve Electrochemical Performance of Li-S Batteries by Optimizing Electrodes, Electrolytes, Separators and Cell Architectures](#)

15:00 to 15:20

Hatem M.A. Amin (Institute of Physical and Theoretical Chemistry, University of Bonn, Bonn, Germany), Christoph Molls, Helmut Baltruschat

[Electrocatalytic Activity of Co₃O₄-Based Catalyst in DMSO Electrolyte and Study of G4-DMSO Mixed Solvent for Li-O₂ Batteries](#)

15:20 to 15:40

Klemen Pirnat (L10 Laboratory for Materials Chemistry, National Institute of Chemistry, Ljubljana, Slovenia), Jan Bitenc, Tanja Banèè, Miran Gaberscek, Bostjan Genorio, Anna Randon-Vitanova, Robert Dominko

[Rechargeable Magnesium Battery with Anthraquinone-Based Polymer as Cathode](#)

15:40 to 16:20 KEYNOTE

Yang-Kook Sun (Department of Energy Engineering, Hanyang University, Seoul, Korea)

[Next Generation Cathode Materials for High-Energy Lithium-Ion Batteries](#)

16:20 to 16:40

Coffee Break

16:40 to 17:00 INVITED

Alejandro A. Franco (Laboratoire de Réactivité et Chimie de Solides (LRCS), Université de Picardie Jules Verne & CNRS (UMR 7314), Amiens, France)

[Multiscale computational modeling to the rescue of lithium-ion and post-lithium batteries: myths, facts and challenges](#)

17:00 to 17:20 INVITED

Marca Doeff (Energy Storage and Distributed Resources Division, Lawrence Berkeley National Laboratory, Berkeley, USA)

[The Promise of Sodium-Ion Batteries](#)

17:20 to 17:40

Christoph Vaalma (Helmholtz Institute Ulm, Karlsruhe Institute of Technology, Ulm, Germany), Daniel Buchholz, Stefano Passerini

[Non-Aqueous Potassium-Ion Batteries](#)

17:40 to 18:00

Yoji Sakurai (Electrical and Electronic Information Engineering, Toyohashi University of Technology, Toyohashi, Japan), Hayato Tawa, Yuki Ishihara, Noriyuki Oshida, Ryoji Minami, Yoshiaki Murata, Tomohiro Tojo, Ryoji Inada

[Electrochemical Characterization of Layered \$\alpha\$ -MoO₃ Electrode Material for Calcium Ion Battery](#)

18:00 to 18:20

Aurèlie Guéguen (Electrochemistry Laboratory, Paul Scherrer Institute, Villigen, Switzerland), Daniel Streich, Minglong He, Petr Novák, Erik J. Berg

[Decomposition in LiPF₆ in high energy Li-ion batteries studied with online electrochemical mass spectrometry](#)

18:20 to 18:40

Liuqing Yang (Department of Chemical and Biomolecular Engineering, National University of Singapore, Singapore, Singapore), Jingfa Li, Xi Jiang, Jim Yang Lee

[Lithiated Graphite Felt/Lithium Hybrid Anode Enables High Performance in Redox Flow Lithium-Polysulfides Battery](#)

s07 Novel Materials and Devices for Energy Conversion and Storage: Fuel Cells, Electrolysers, Regenerative Fuel Cells and Flow Batteries

Room : King Willem Alexander

Chaired by: Simon Thiele

14:00 to 14:20

Anna K. Schuppert (Heterogeneous Reactions, Max-Planck Institute for Chemical Energy Conversion, Muelheim, Germany), Andrea Zitolo, Moulay Tahar Sougrati, Deborah Jones, Frederic Jaouen

[Ultra-Low Amounts of Pt stabilize Non-Precious Metal Catalysts for Oxygen Reduction](#)

14:20 to 14:40 INVITED

Piotr Zeleny (Materials Physics and Applications Division, Los Alamos National Laboratory, Los Alamos, USA), Hoon T. Chung, Ulises Martinez, Ling Lin, Xi Yin, Geraldine M. Purdy, Edward F. Holby

[Recent Progress in the Development of Non-Precious Metal ORR Catalysts for Fuel Cells](#)

14:40 to 15:00

Qingfeng Li (Department of Energy Storage and Conversion, Technical University of Denmark, Lyngby, Denmark), Yang Hu, Lijie Zhong, Lars N. Cleemann, Jens Oluf Jensen

[High Pressure Synthesis of Non-precious Metal ORR Catalysts for Low Temperature Fuel Cells](#)

15:00 to 15:20

Daniel Malko (Department of Chemistry, Imperial College London, London, United Kingdom), Thiago Lopes, Anthony Kucernak

[In-situ electrochemical quantification of active sites in Fe-N/C non-precious metal catalysts](#)

15:20 to 15:40

Ioanna Martinaiou (Department of Materials- and Earth Science, Technical University of Darmstadt, Darmstadt, Germany), Fabian Grimm, Ali Shahraei, Sabine Hesse, Robert Stark, Carolin Wittich, Hans-Joachim Kleebe, Ulrike I. Kramm

[Influence of the structural composition on the activity and stability of Me-N-C electrocatalysts for the Oxygen Reduction Reaction \(ORR\)](#)

15:40 to 16:00

Ken Sakaushi (International Center for Materials Nanoarchitectonics, National Institute for Materials Science, Tsukuba, Japan), Kohei Uosaki

[In Search of Carbon-, Nitrogen- Compounds for Hydrogen and Oxygen Electrocatalytic Reactions: Correlation of Catalytic Activity, Pore- and Chemical-Structures](#)

16:00 to 16:20

Satoko Takase (Department of Applied Chemistry, Kyushu Institute of Technology, Kitakyushu, Japan), Daiki Ikeda, Kotomi Ando, Youichi Shimizu

[Oxygen Reduction Properties of Structure-Controlled Metal Phthalocyanine Electrocatalysts in Acidic Condition](#)

16:20 to 16:40

Coffee Break

16:40 to 17:20 KEYNOTE

Peter Strasser (Chemistry, Tu Berlin, Berlin, Germany), Mikaela Gorlin, Jorge Ferreira de Araujo, Soeren Dresp, Fabio Dionigi, Petko Chernev, Holger Dau

[Electrochemical water splitting on NiFe oxide nanocatalysts](#)

17:20 to 17:40

Eleonora Zamburlini (Physics, Technical University of Denmark, Kongens Lyngby, Denmark), Bjorn Wickman, Niklas Lindahl, Maria Escudero-Escribano, Ifan Stephens, Ib Chorkendorff
Pt-rare earth alloys thin films as efficient catalysts for oxygen electroreduction

17:40 to 18:00

Laetitia Dubau (LEPMI, CNRS, Saint Martin d'Hères, France), Jaysen Nelayah, Simona Moldovan, Ovidiu Ersen, Pierre Bordet, Jakub Drnec, Tristan Asset, Chattot Raphaël, Frédéric Maillard

[Defects do Catalysis: CO Monolayer Oxidation and Oxygen Reduction Reaction on Hollow PtNi/C Nanoparticles](#)

18:00 to 18:20

Juan Herranz (Electrochemistry Laboratory, Paul Scherrer Institut, Villigen, Switzerland), Sebastian Henning, Laura Kühn, Wei Liu, Alexander Eychmüller, Thomas Justus Schmidt

[Unsupported Pt-Ni Aerogels as Oxygen Reduction Catalysts for Polymer Electrolyte Fuel Cells](#)

18:20 to 18:40

Isaac Adjei Safo (Electrocatalysis Group, Dept. of Physical Chemistry, Carl von Ossietzky University of Oldenburg, Oldenburg, Germany), Jan-Steffen Haverkamp, Rieke Meinen, Burkhard Hecker, Mehtap Oezaslan

[Structural Loss of Shape-controlled Platinum Nanoparticles for PEFC Application](#)

s08 Novel Materials and Devices for Energy Storage: Capacitors

Room : Oceania Foyer

Chaired by: *Thierry Brousse and Wataru Sugimoto*

14:00 to 14:20 INVITED

Chi-Chang Hu (Department of Chemical Engineering, National Tsing Hua University, Hsinchu, Taiwan), Da-Je Hsu, Yu-Wen Chi, Hsiao-Hsuan Shen

[Electrochemical Activation of Carbons for Enhancing the Capacitive Performances of Organic Electrical Double-Layer Capacitors](#)

14:20 to 14:40 INVITED

Thierry Brousse (Institut des Matériaux de Nantes, CNRS, University of Nantes, Nantes, France), Nicolas Goubard-Bretesché, Gaëtan Buvat, Olivier Crosnier, Camille Douard, Antonella Iadecola, Stéphanie Belin, Richard Retoux, Christophe Payen, Frédéric Favier, Kazuaki Kisu, Etsuro Iwama, Katsuhiko Naoi

[Pseudocapacitive FeWO₄ compound: from fundamental to applications](#)

14:40 to 15:00

Agnieszka Brzózka (Institute of Chemistry and Technical Electrochemistry, Poznan University of Technology, Poznan, Poland), Krzysztof Fic, Grzegorz Sulka

[Conducting Polymer Nanowire Arrays for Supercapacitor Application](#)

15:00 to 15:20

Krzysztof Fic (Institute of Chemistry and Technical Electrochemistry, Poznan University of Technology, Poznan, Poland), Barbara Gorska, Paulina Bujewska, François Béguin, Elzbieta Frackowiak

[Pseudohalide-based Electrolytes For High-Energy Electrochemical Capacitors](#)

15:20 to 15:40

Juhan Lee (Energy Materials, INM - Leibniz Institute for New Materials, Saarbrücken, Germany), Soumyadip Choudhury, Volker Presser

[High voltage hybrid electrochemical energy storage with potassium ferricyanide: synergy of double-layer formation and soluble redox](#)

15:40 to 16:00

Christian Koczwar (Institute of Physics, Montanuniversität Leoben, Leoben, Austria), Nicolas Jäckel, Anna Schreiber, Max Burian, Heinz Amenitsch, Markus A. Hartmann, Volker Presser, Oskar Paris, Christian Prehal

[Quantifying local ion rearrangement in nanoporous carbon supercapacitors using in-situ small angle X-ray scattering](#)

16:00 to 16:20

Asuman Unal (Chemistry, University of Leicester, Leicester, United Kingdom), Robert Hillman, Karl S. Ryder

[The Effect of MWCNT on Electrochemical Deposition of Polyaniline and Polypyrrole Films and Their Redox Switching in Ionic Liquid](#)

16:20 to 16:40

Coffee Break

16:40 to 17:00

Magdalena Skunik-Nuckowska (Department of Chemistry, University of Warsaw, Warsaw, Poland), Joanna Szymczyk, Sławomir Dyjak, Paweł J. Kulesza

[Tungsten Polyoxometalates for Redox Electrolyte Enhanced Supercapacitors](#)

17:00 to 17:20

Heejoon Ahn (Department of Organic and Nano Engineering, Hanyang University, Seoul, Korea), Sang Hyun Lee, Sung Hyeon Park, Hak-Sung Kim

[Intense Pulsed White Light \(IPWL\)-assisted Facile and Agile Fabrication of Metal and Metal Oxide Nanostructures for High Performance Supercapacitor Applications](#)

17:20 to 17:40

Vladislav Ivanistsev (Institute of Chemistry, University of Tartu, Tartu, Estonia), Maksim Mišun, Maxim V. Fedorov

[Structural transitions in the double layer and properties of ionic liquid–electrode interfaces: a computational perspective](#)

17:40 to 18:00

Yuqing Liu (Intelligent Polymer Research Institute, University of Wollongong, Wollongong, Australia),
Joselito M. Razal, Gordon Wallace, Jun Chen

[Flexible Supercapacitor Designs based on rGO-PEDOT/PSS Film](#)

18:00 to 18:20

Evgeny Senokos (Multifunctional Nanocomposites Group, IMDEA Materials Institute, Getafe, Spain), Victor Reguero, Jesús Palma, Juan Jose Vilatela, Rebeca Marcilla

[Development of Multifunctional EDLC based on Macroscopic Fibres of CNTs](#)

18:20 to 18:40

Kumar Raju (Energy Materials, Council for Scientific and Industrial Research, Pretoria, South Africa), Funeka P. Nkosi, P. Nithyadharseni, Mkhulu K. Mathe, Kenneth I. Ozoemena

[Graphene Oxide Decorated LiNiPO₄ Nanorods as a Potential Positive Electrode for High Energy Density Li-Ion Hybrid Capacitors](#)

s09 Capacitive Electrodes for Environmental Technology

Room : Yangtze 2

Chaired by: Maarten Biesheuvel

14:00 to 14:40 KEYNOTE

Bert Hamelers (Wetsus, Leeuwarden, Netherlands), Louis Legrand, Olivier Schaetzle, Robert de Kler, Maarten Biesheuvel

[The Electrosorption Process for Energy Generation](#)

14:40 to 15:00 INVITED

Chad Vecitis (Paulson School of Engineering and Applied Sciences, Harvard University, Cambridge, USA), Gregory Silverberg

[Nanoarchitected Graphene Oxide Capacitive Electrodes](#)

15:00 to 15:20

Youri Gendel (Civil and Environmental Engineering, Technion - Israel Institute of Technology, Haifa, Israel), Christian Linnartz

[Application of flow electrode capacitive deionization for the double displacement reactions](#)

15:20 to 15:40

Piotr Dlugolecki (Technology Development, Voltea, Sassenheim, Netherlands), Aurora Spragg, Carlos Camero, Bryan Brister

[Membrane Capacitive Deionization Applied for High-Temperature Water Reuse Applications](#)

15:40 to 16:00 INVITED

Chia-Hung Hou (Graduate Institute of Environmental Engineering, National Taiwan University, Taipei, Taiwan)

[Applications of Capacitive Electrodes in the Electrosorption Process for Water Purification](#)

16:00 to 16:20

Jouke Dykstra (Department of Environmental Technology, Wageningen University / Wetsus, Wageningen, Netherlands), Albert van der Wal, Maarten Biesheuvel

[Modeling pH fluctuations in Membrane Capacitive Deionization](#)

16:20 to 16:40

Coffee Break

16:40 to 17:20 KEYNOTE

Volker Presser (Chair of Energy Materials, INM - Leibniz Institut für Neue Materialien, Saarbrücken, Germany)

[Design of nanoporous carbon electrodes for water desalination via capacitive deionization](#)

17:20 to 17:40 INVITED

James Landon (Center for Applied Energy Research, University of Kentucky, Lexington, USA), Ayokunle Omosebi, Xin Gao, Kunlei Liu

[Surface Charge of Carbon Electrodes for Capacitive Deionization](#)

17:40 to 18:00

Jianyun Liu (Environmental Engineering, Donghua University, Shanghai, China)
Various Activated Carbon Composite Recipes for Capacitive Deionization Device

18:00 to 18:20

Yu-Hsuan Liu (Environmental Engineering, National Taiwan University, Taipei, Taiwan), Chia-Hung Hou

[Development of Manganese Dioxide-Activated Carbon Composite Electrodes for Enhancing Capacitive Deionization Performance by Pseudocapacitance](#)

18:20 to 18:40

Matthew Suss (Mechanical Engineering, Technion - Israel Institute of Technology, Haifa, Israel), Maarten Biesheuvel

[Capacitive deionization: emerging trends and new directions](#)

TUESDAY PM

s11 Electrochemical Engineering for Improvement of Process Sustainability

Room : Europe

Chaired by: Edward Roberts

14:00 to 14:20 INVITED

Romeu C. Rocha-Filho (Dept. of Chemistry, Universidade Federal de São Carlos, São Carlos, Brazil), Gabriel F. Pereira, Bianca F. da Silva, Regina V. Oliveira, Douglas A.C. Coledam, Jose Mario Aquino, Nerilso Bocchi, Sonia R. Biaggio

[Electrochemical degradation of the herbicide tebuthiuron using a boron-doped diamond or \$\beta\$ -PbO₂ anode in a flow system](#)

14:20 to 14:40

Jan-Christian Wiencke (Ironmaking, Global Research and Development, ArcelorMittal Maizières Research SA, Maizières-lès-Metz, France), Hervé Lavelaine, Pierre-Jean Panteix, Carine Petitjean, Christophe Rapin

[Electrochemical production of liquid iron via Molten Oxide Electrolysis](#)

14:40 to 15:00

Karine Groenen Serrano (Laboratoire de Génie Chimique, University Paul Sabatier, Toulouse, France), Yandi Lan, Clémence Coetsier, Christel Causserand

[Role of Salts on the Pharmaceuticals Remediation by Electrochemical Oxidation](#)

15:00 to 15:20 INVITED

Carlos Alberto Martinez-Huitle (Federal University of Rio Grande do Norte, Natal, Brazil), Camila Carvalho de Almeida, Danyelle Medeiros de Araujo, Katlin Eguiluz, Giancarlo Salazar-Banda

[Role of Bromide Release during the Anodic Oxidation of Bromophenol Blue dye: Hypobromite ion Formation](#)

15:20 to 15:40

Ricardo Salazar (Química de los Materiales, University of Santiago of Chile, Santiago, Chile)

[Treatment of winery wastewater by electro-oxidation with BDD electrode](#)

15:40 to 16:00

Tzayam Pérez (División de Ingenierías, Universidad de Guanajuato, Guanajuato, Mexico), Ignacio Sirés, Enric Brillas, José L. Nava

[Solar Photoelectro-Fenton Degradation of the Antibiotic Erythromycin Using a Recirculation Flow Plant with a FM01-LC Cell and a CPC Photoreactor](#)

16:00 to 16:20

Salvador Cotillas (Chemical Engineering Department, University of Castilla-La Mancha, Ciudad Real, Spain),
María J. Martín de Vidales, Leonor Cañizares, María P. Castro, Cristina Sáez, Pablo Cañizares, Manuel A.
Rodrigo

[Electrolytic and electro-irradiated technologies with diamond anodes for the removal of pesticide clopyralid from soil washing wastes](#)

16:20 to 16:40

Coffee Break

16:40 to 17:00

Clément Trellu (Laboratoire Géomatériaux et Environnement, University Paris-Est, Noisy-le-Grand, France),
Oleksandra Ganzenko, Stefano Papirio, Yoan Pechaud, Nihal Oturan, David Huguenot, Eric Van Hullebusch,
Giovanni Esposito, Mehmet A. Oturan

[Treatment of Soil Washing Solution by Combined Processes Coupling Anodic Oxidation and Biological Treatment](#)

17:00 to 17:20

Elisama Santos (School of Science and Technology, Federal University of Rio Grande do Norte, Natal, Brazil),
Cristina Sáez, Pablo Cañizares, Carlos Alberto Martinez-Huitle, Manuel Andres Rodrigo

[Treating soil-washing effluents polluted with oxyfluorfen by sonolysis and sono-electrolysis with diamond anodes](#)

17:20 to 17:40

Henry Bergmann (FB 6&7, Anhalt University, Köthen/Anh., Germany), Jens Hartmann, Tatiana Iourtchouk,
Daniela Nordmann

[On the AOX formation during Inline Electrolysis at Laboratory Scale](#)

17:40 to 18:00

Erika Bustos (Science, Centro de Investigación y Desarrollo Tecnológico en Electroq, Pedro Escobedo,
Mexico), Verónica Herrada, Gustavo Acosta-Santoyo

[A Potato Tubers Based Biocell for Detoxification of Mercury – Polluted Soils and Generation of Bioelectricity](#)

18:00 to 18:20

Minghua Zhou (College of Environmental Science and Engineering, Nankai University, Tianjin, China)

[Comparative study of acrylonitrile degradation by electrocoagulation, electro-Fenton and peroxi-coagulation](#)

18:20 to 18:40

Audrey Iranzo (Chemical Engineering, Laboratoire de Génie Chimique, Université Paul Sabatier, Toulouse,
France), Fabien Chauvet, Theo Tzedakis

[Growth and dispersion of iron electrodeposits under ultrasonification](#)

s13 Corrosion: The Electrochemistry of Corrosion and Approaches to Corrosion Protection

Room : Amazon

Chaired by: Mary Ryan and Shinji Fujimoto

14:00 to 14:20

Shinji Fujimoto (Division of Materials and Manufacturing Science, Osaka University, Suita, Osaka, Japan),
Shohei Hasegawa, Hiroaki Tsuchiya

[Cathodic Reactions on Passive Films Evaluated by Transient Potential Measurement During and After Pulse Galvano-static Polarization](#)

14:20 to 14:40

Jan Philipp Kollender (Institute for Chemical Technology of Inorganic Materials, Johannes Kepler University
Linz, Linz, Austria), Achim Walter Hassel

[Online monitoring of metal dissolution during anodisation of Ti, Nb and Ta](#)

14:40 to 15:00

Barbara Laurent (DEN/DANS/DPC/SCCME/LECNA, Commissariat à l'Énergie Atomique de Saclay, Gif sur Yvette, France), Nathalie Gruet, Benoît Gwinner, Frederic Miserque, Michel Tabarant, Kevin Ogle

[Elemental selective dissolution of a silicon-rich austenitic stainless steel in acidic medium investigated through Atomic Emission Spectro Electrochemistry](#)

15:00 to 15:20

Ying Li (Laboratory for Corrosion and Protection, Institute of Metal Research, Shenyang, China), Chen Pan, Tianshu Li, Li Liu

[Study the corrosion behaviour of sputtered nanocrystalline stainless steel coating by electrochemical measurements and in-situ AFM technique](#)

15:20 to 15:40

Herman Terryn (Research Group Electrochemical and Surface Engineering, Vrije Universiteit Brussel, Brussels, Belgium), Hans Simillion, Nils Van den Steen, Olga Dolgikh, Deconinck Johan

[Atmospheric corrosion prediction by electrochemical modelling](#)

15:40 to 16:00

Bernard Tribollet (LISE UMR 8235, UPMC, Paris, France), Mai Tran, Eliane Sutter

[Advances in the Use of EIS Methods for the Analysis of an Aluminium Oxide Layer in the Cathodic Domain](#)

16:00 to 16:20

Hanna Sopha (Center of Materials and Nanotechnologies, Faculty of Chemical Technology, University of Pardubice, Pardubice, Czech Republic), Ales Jäger, Petr Knotek, Jan M. Macak

[Self-Organized TiO₂ Nanotubes: Influence of the Ti Microstructure on the Nanotube Growth](#)

16:20 to 16:40

[Coffee Break](#)

16:40 to 17:00

Monica Santamaria (Electrochemical Materials Science Laboratory, DICAM, University of Palermo, Palermo, Italy), Francesco Di Franco, Giuseppe Massaro, Francesco Di Quarto

[Monitoring of Rouging and De-Rouging of Stainless Steel for Chemical Reactors by Photoelectrochemical and Impedance Measurements](#)

17:00 to 17:20

David Holuscha (Corrosion, DECHEMA Forschungsinstitut, Frankfurt am Main, Germany), Wolfram Fürbeth, Christian Thyssen, Wolfgang Sand

[Cyclodextrin-modified steel surface for inhibition of \(a\)biotic corrosion](#)

17:20 to 17:40

Sviatlana V. Lamaka (MagIC - Magnesium Innovation Center, Helmholtz-Zentrum Geesthacht, Geesthacht, Germany), Anissa Bouali, Darya Snihirova, Maryna Taryba, Maria Serdechnova, M. Fatima Montemor, Mikhail L. Zheludkevich

[False Positives on Self-healing by SVET](#)

17:40 to 18:00

Dandapani Vijayshankar (Interface Chemistry and Surface Engineering, Max-Planck-Institut für Eisenforschung GmbH, Düsseldorf, Germany), Abdulrahman Altin, Michael Rohwerder

[A Novel Potentiometric Approach to a Quantitative Characterization of Oxygen Reduction Kinetics at Buried Metal – Organic Coating Interfaces](#)

18:00 to 18:20

Yang Yu (Department of Materials Science and Technology, Nagaoka University of Technology, Nagaoka, Japan), Sayoko Shironita, Kunio Nakatsuyama, Kenichi Souma, Minoru Umeda

[High Temperature Nitriding of Ni-free Ferrite SUS445 Stainless Steel for Bipolar Plate in PEFCs](#)

18:20 to 18:40

Bibiana Fernández-Pérez (Department of Chemistry, University of La Laguna, La Laguna, Spain), Vicente Mena, Juan J. Santana, Javier Izquierdo, Ricardo M. Souto

[Combined Imaging of Topography and Local Chemical Activity for the Characterization of Thin Films and Coatings by Scanning Electrochemical Microscopy](#)

s14 Combined Electro and Electrophoretic Deposition for Advanced Materials Synthesis

Room : Everest

Chaired by: Aldo Boccaccini, Begoña Ferrari and Marcel J. Rost

14:00 to 14:40 KEYNOTE

Jan Fransaer (Department of Materials Engineering, KU Leuven, Heverlee, Belgium), Ellad Tadmor, Linda Stappers, Christian Ntumba-Ngoy, Dimitri Soccol, Minxian Wu

[New insights and applications of electrocodeposition](#)

14:40 to 15:00 INVITED

Olaf Magnussen (Institute of Experimental and Applied Physics, Kiel University, Kiel, Germany)

[Operando Studies of Electrodeposition Processes by Novel Synchrotron X-ray Scattering Techniques](#)

15:00 to 15:20

Jon Ustarroz (Electrochemical and Surface Engineering (SURF), Vrije Universiteit Brussel, Brussels, Belgium), Minkyung Kang, Erin Bullions, Annick Hubin, Patrick Unwin

[Electrochemical deposition and dissolution at the single nanoparticle level](#)

15:20 to 15:40

Meng Nan Chong (School of Engineering, Chemical Engineering Discipline, Monash University Malaysia, Bandar Sunway, Malaysia), Tao Zhu, Yi Wen Phuan, Chong Siang Yaw, Chun Yuan Chot

[Understanding the Photogenerated Charge Transfer Properties and Photoelectrocatalytic Water Oxidation Ability in Electrochemically Synthesized Semiconductor Thin Films and Heterojunction Structures](#)

15:40 to 16:00

Elizabeth Oseland (Department of Chemistry, University of Warwick, Coventry, United Kingdom)

[Meniscus Confined Micropatterning of Polyacrylamide Gel Using Scanning Electrochemical Cell Microscopy \(SECCM\)](#)

16:00 to 16:20

Karl S. Ryder (Department of Chemistry, University of Leicester, Leicester, United Kingdom), Marian Perera, Christopher Zaleski, Robert Hillman

[Characterization of Ag-Bi Alloy Film Deposition and Dissolution Using Electrochemical, Acoustic Wave and Optical Measurements](#)

16:20 to 16:40

Coffee Break

16:40 to 17:20 KEYNOTE

Laxmidhar Besra (Colloids and Materials Chemistry, Institute of Minerals and Materials Technology (IMMT), Bhubaneswar, India)

[Electrophoretic Deposition as a Versatile Technique for Advanced Materials and Coatings: Interfacial Phenomena](#)

17:20 to 17:40 INVITED

Claudine Filiâtre (Institut UTINAM-UMR6213, University of Bourgogne, Franche-Comté, Besançon, France), Cédric Buron, Myriam Euvrard, Céline Pignolet, Alexandra Monnin

[Electrophoretic Deposition and Assembly of Functionalised Colloidal Particles in Aqueous Media: Influence of Surfactants, Alternate Polyelectrolyte Multilayer and pH](#)

17:40 to 18:00

Cédric Frantz (Laboratory for Mechanics of Materials and Nanostructures, Empa, Thun, Switzerland), Cristina V. Manzano, Alessandro Lauria, Johann Michler, Markus Niederberger, Laetitia Philippe

[Electrophoretic deposition of TiO₂ nanoparticles on anodized aluminium](#)

18:00 to 18:20

Rosalina Pérez (Ceramic Surfaces, Fundación CIDETEC, San Sebastián, Spain), David Vélez, Ma. Ángeles Corres, Josemari Muñoz, José Antonio Díez

[Electrophoretic Deposition of VITA/Ti6Al4V for Bioinert Ceramic Coatings](#)

18:20 to 18:40

Begoña Ferrari (Ceramica, Instituto de Ceramica y Vidrio, CSIC, Madrid, Spain), Zoilo Gonzalez, Carlos Mendoza, Elena Gordo, Yolanda Castro

[Inducing flocculation of TiN nanoparticles during deposition through their steric stabilization in non-aqueous suspensions](#)

TUESDAY PM

s16 Physical and Interfacial Electrochemistry: Progress in Spectroscopy, Imaging and Theoretical Analysis

Room : Kilimanjaro

Chaired by: Dan Bizzotto and Juan Miguel Feliu Martinez

14:00 to 14:20

Sylvain Brimaud (Institute of Surface Chemistry and Catalysis, Ulm University, Ulm, Germany), Albert Engstfeld, Elena Fischer, R. Jürgen Behm

[The properties of Pt-ML electrocatalytic surfaces](#)

14:20 to 14:40

Federico Calle-Vallejo (Leiden Institute of Chemistry, Leiden University, Leiden, Netherlands), Marc Koper

[Structure-Activity Relationships in the electroreduction of CO and CO₂ on copper catalysts](#)

14:40 to 15:00

Anna Wuttig (Chemistry, Massachusetts Institute of Technology, Cambridge, USA), Can Liu, Qiling Peng, Momo Yaguchi, Shen Ye, Kenta Motobayashi, Masatoshi Osawa, Yogesh Surendranath

[Dynamics of Adsorbed Intermediates during Cu-Catalyzed CO₂-to-Fuels Catalysis](#)

15:00 to 15:20

Karen Chan (SUNCAT Center for Interface Science and Catalysis, Stanford University, SLAC National Accelerator Laboratory, Stanford, Menlo Park, USA), Michal Bajdich, Leanne D. Chen, Robert Sandberg, Jianping Xiao, Jens. K Nørskov

[Theoretical Investigations of Electrochemical CO₂ Reduction](#)

15:20 to 15:40 INVITED

Elisabet Ahlberg (Department of Chemistry and Molecular Biology, University of Gothenburg, Gothenburg, Sweden), Kristoffer Hedenstedt, Joakim Bäckström

[Water Reduction on \$\alpha\$ - and \$\gamma\$ -FeOOH: *In-situ* Raman Spectroscopy](#)

15:40 to 16:00

Stefan Ringe (Chair f. Theoretical Chemistry and Catalysis Research Center, Technische Universität München, Garching, Germany), Harald Oberhofer, Sebastian Matera, Karsten Reuter

[Function-Space Based Solution Scheme for the Size-Modified Poisson-Boltzmann Equation in Full-Potential DFT](#)

16:00 to 16:20

Rachel Sapstead (Chemistry, University of Leicester, Leicester, United Kingdom), Karl S. Ryder, Robert Hillman, Virginia Ferreira, Emma Smith, Robert Dalglish, Nina-Julienne Steinke

[Acquisition of Time-Resolved Neutron Reflectivity Data for Dynamic Electrochemical Experiments](#)

16:20 to 16:40

Coffee Break

16:40 to 17:20 KEYNOTE

Philip Bartlett (Chemistry, University of Southampton, Southampton, United Kingdom)

[Plasmonic surfaces for electrochemical surface enhanced Raman spectroscopy](#)

17:20 to 17:40

Katrin F. Domke (Molecular Spectroscopy Department, MPI Polymer Research, Mainz, Germany)

[Electrochemical TERS of adenine re-orientation on Au\(111\)](#)

17:40 to 18:00

Andrew Wain (Materials Division, National Physical Laboratory, Teddington, United Kingdom)

[Probing Catalytic Hydrogenation at Single Crystal Electrodes using Electrochemical Surface-Enhanced Raman Spectroscopy](#)

18:00 to 18:20 INVITED

Nagahiro Hoshi (Department of Applied Chemistry and Biotechnology, Chiba University, Chiba, Japan),
Masashi Nakamura, Fumiya Sugimura, Katsuyoshi Ikeda

[Surface Enhanced Raman Spectroscopy on Well-Defined Low Index Planes of Pt in Ar and O₂ Saturated Solutions](#)

18:20 to 18:40 INVITED

Kei Murakoshi (Department of Chemistry, Hokkaido University, Sapporo, Japan)

[Surface-Enhanced Raman Scattering as a Probe for Interaction between Photons and Molecules at Electrified Interfaces](#)

Wednesday, 24 August 2016

ROOMS:	Mississippi	Yangtze 1	Oceania	King Willem Alexander	Oceania Foyer	Europe	Amazon	Everest	Kilimanjaro	Yangtze 2
SYMPOSIUM	Symposium 2	Symposium 3	Symposium 6	Symposium 7	Symposium 19	Symposium 10	Symposium 13	Symposium 5	Symposium 16	Symposium 9
08:15 - 09:15	Plenary Lecture: Anders Nilsson (King Willem Alexander)									
09:30 - 09:50	Klaus Mathwig	George Wilson	Reza Younesi	Christina Roth	Katherine Ayers	Mikhael Levi	M. F. Montemor	Leonard Tender	Michael Eikerling	T. Alan Hatton
09:50 - 10:00	Qijin Chi	Marta Pozuelo	Prabeer Barpanda	Jochen Friedl	Joojie van Bennekom	Sébastien Moitzheim	Nadine Pebere	Annemiek Ter Heijne	Elena Savinova	E. Julio Calvo
10:00 - 10:10		Xinxin Xiao		N. Roznyatovskaya	Henri Barde		Eduardo Ponzio			
10:10 - 10:20	Paul Bohn	M. Murawska	Yong-Sheng Hu	Matthias Steirmecke	Thijs de Groot	Daniel Scherson	Matthias Uebel	Antonin PrévotEAU	Ulmas E. Zhumaev	Kyle Smith
10:20 - 10:30		J. Alv.-Malmagro								
10:30 - 10:40		Michal Kizling								
10:40 - 10:50		Galina Pankratova								
10:50 - 11:10	Coffee Break &									
11:10 - 11:30	X. Domin.-Benetton									
11:30 - 11:50	POSTER SESSION 3 (s8, s9, s12, s13, s14, s15, s16, s17, s18, s20)									
11:50 - 12:10										
12:10 - 12:30										

Wednesday, 24 August 2016, Morning

Plenary Lecture

Room : King Willem Alexander

Chaired by: Katharina Krischer

08:15 to 09:15

Anders Nilsson (Department of Physics, AlbaNova University Center, Stockholm, Sweden)

[Operando X-ray Studies of Electrocatalysis](#)

s02 Nanostructured Materials in Electroanalytical Chemistry

Room : Mississippi

Chaired by: Tim Albrecht and Leyla Soleymani

09:30 to 09:50 INVITED

Klaus Mathwig (Groningen Research Institute of Pharmacy, University of Groningen, Groningen, Netherlands)

[Stochastic Amperometry in Nanofluidic Electrochemical Sensors](#)

09:50 to 10:10 INVITED

Qijin Chi (DTU Chemistry, Technical University of Denmark, Kgs. Lyngby, Denmark), Minwei Zhang, Arnab Halder, Chengyi Hou

[Electrochemical nanomaterials synthesized using graphene as scaffolds or templates for analytical and sensing applications](#)

10:10 to 10:50 KEYNOTE

Paul Bohn (Chemical and Biomolecular Engineering, University of Notre Dame, Notre Dame, USA), Chaoxiong Ma, Lawrence Zaino Jr., Wei Xu, Erick Foster, Donghoon Han Redox Cycling in Zero-Dimensional Nanoelectrode Arrays with Fluorogenic Redox Reporters

10:50 to 11:10

Coffee Break

s03 New Approaches for Interfacing Electrochemistry and Biological Systems

Room : Yangtze 1

Chaired by: Damien Arrigan and Renata Bilewicz

09:30 to 09:50 **KATSUMI NIKI PRIZE FOR BIOELECTROCHEMISTRY**

George Wilson (Chemistry, University of Kansas, Lawrence, USA)

[Bioelectrochemistry: The Nature of the Electrode-Biological Interface](#)

09:50 to 10:00

Marta Pozuelo (Nanoprobes and Nanoswitches, Institute for Bioengineering of Catalonia (IBEC), Barcelona, Spain), Juan Manuel Artes Vivancos, Fausto Sanz, Pau Gorostiza, Ismael Díez-Pérez

[Studying charge transport in Single-Protein wires](#)

10:00 to 10:10

Xinxin Xiao (Materials and Surface Science Institute, University of Limerick, Limerick, Ireland), Kalso Hussein, Peter O'Conghaile, Donal Leech, Edmond Magner

[When enzymatic biofuel cell meets flow cell: How hydrodynamic flow affects performance](#)

10:10 to 10:20

Magdalena Murawska (Chemistry, Centre de Recherche Paul Pascal, Pessac, France), A. Karajic, M. Heim, Stéphane Reculosa, S. Ravaine, N. Mano, Alexander Kuhn

[Designing highly organized porous electrode architectures as a dual host for tailored enzymes](#)

10:20 to 10:30

Julia Alvarez-Malmagro (Química Física, Universidad de Sevilla, Sevilla, Spain), ZhanFei Su, Jacek Lipkowski, Manuela Rueda, Francisco Prieto

Biomimetic bilayer consisting of 1-hexadecanethiol and a cytidine nucleolipid supported on the Au(111) electrode: A spectroelectrochemical study by PM-IRRAS

10:30 to 10:40

Michał Kizling (Faculty of Chemistry, Warsaw University, Warsaw, Poland), Krzysztof Stolarczyk, Leif Nyholm, Renata Bilewicz

[Application of cellulose/conductive polymer paper as free standing matrix for enzyme immobilization in enzymatic fuel cell](#)

10:40 to 10:50

Galina Pankratova (Department of Biochemistry and Structural Biology, Lund University, Lund, Sweden), Kamrul Hasan, Donal Leech, Lars Hederstedt, Lo Gorton

[Electrochemical Study of the Extracellular Electron Transfer of *Enterococcus faecalis* to Electrodes](#)

10:50 to 11:10

Coffee Break

s05 Current Progress in Microbial Electrochemical Technologies

Room : Everest

Chaired by: Bert Hamelers

09:30 to 10:10 KEYNOTE

Leonard Tender (Center for Bio/Molecular Science and Engineering, Naval Research Laboratory, Washington, USA)

[Understanding Electron Transport in a Durable Mixed Community Microbial Biocathode Enriched from Seawater](#)

10:10 to 10:30 INVITED

Annemiek Ter Heijne (Sub-department of Environmental Technology, Wageningen University, Wageningen, Netherlands), Dandan Liu, Tom Sleutels, Fran Fabregat-Santiago

[Characterization of Bio-anode Capacitance on Fluorine Tin Oxide \(FTO\) Electrodes using Electrochemical Impedance Spectroscopy](#)

10:30 to 10:50 INVITED

Antonin PrévotEAU (Laboratory of Microbial Ecology and Technology, Ghent University, Ghent, Belgium), Annelies Geirnaert, Jan Arends, Sylvain Lannebère, Tom Van de Wiele, Korneel Rabaey

[Hydrodynamic Chronoamperometry for Probing Kinetics of Microbial Metabolism](#)

10:50 to 11:10 INVITED

Ramaraja Ramasamy (College of Engineering, University of Georgia, Athens, USA)

[Understanding Extracellular Electron Transport in Electrochemically Active Microorganisms](#)

11:10 to 11:30 INVITED

Xochitl Dominguez-Benetton (Separation and Conversion Technology, VITO, Mol, Belgium)

[Electrochemical Equilibria on Microbial-Electrometallurgical Systems](#)

s06 Novel Materials and Devices for Energy Storage: Batteries for Tomorrow's World

Room : Oceania

Chaired by: Yong-Sheng Hu and Fokko Mulder

09:30 to 09:50

Reza Younesi (Department of Chemistry, Ångström Laboratory, Uppsala University, Uppsala, Sweden), Habtom Desta Asfaw, Mario Valvo, Kristina Edström

[Solid Electrolyte Interphase on Hard Carbon Anodes in Na-ion Batteries](#)

09:50 to 10:10 **ISE PRIZE FOR APPLIED ELECTROCHEMISTRY**

Prabeer Barpanda (Materials Research Center, Indian Institute of Science, Bangalore, India), Ritambhara Gond, Ganesh Shinde

[Insights on New Phosphate Compounds for Na-ion Batteries](#)

10:10 to 10:50 KEYNOTE - **TAJIMA PRIZE**

Yong-Sheng Hu (Key Laboratory for Renewable Energy, Institute of Physics, Chinese Academy of Sciences, Beijing, China)

[Prototype Na-Ion Batteries for Grid-Scale Energy Storage](#)

10:50 to 11:10

Coffee Break

s07 Novel Materials and Devices for Energy Conversion and Storage: Fuel Cells, Electrolysers, Regenerative Fuel Cells and Flow Batteries

Room : King Willem Alexander

Chaired by: Ifan Stephens

09:30 to 09:50 INVITED

Christina Roth (Chemistry and Biochemistry, FU Berlin, Berlin, Germany), Joachim Langner, Igor Derr, Julia Melke, Abdul Monem Fetyan

[Novel carbon-based electrodes for all-V redox flow batteries](#)

09:50 to 10:10

Jochen Friedl (School of Chemistry, Newcastle University, Newcastle upon Tyne, United Kingdom), Ulrich Stimming

[The Composition of the Electrode Determines which Half-Cells Rate Constant is Higher in a Vanadium Flow Battery](#)

10:10 to 10:30

Nataliya Roznyatovskaya (Applied Electrochemistry, Fraunhofer Institute for Chemical Technology, Pfinztal, Germany), Jens Noack, Matthias Fühl, Karsten Pinkwart, Jens Tübke

[Spectrophotometric and Electrochemical Investigation of Vanadium Electrolyte in V^{3.5+} Form for Redox-Flow Batteries: V\(III\)/\(IV\) conversion](#)

10:30 to 10:50

Matthias Steimecke (Institut für Chemie, Martin-Luther-Universität Halle-Wittenberg, Halle, Germany), Stefan Rümmler

[Scanning electrochemical microscopy \(SECM\) as a versatile tool for the evaluation of carbon-based materials employed in all-vanadium redox flow batteries](#)

10:50 to 11:10

Coffee Break

s09 Capacitive Electrodes for Environmental Technology

Room : Yangtze 2

Chaired by: Juan Santiago

09:30 to 10:10 KEYNOTE

T. Alan Hatton (Chemical Engineering, Massachusetts Institute of Technology, Cambridge, USA), Xiao Su, Demetra S. Achilleos, Johannes Elbert, Wenda Tian, Sahag Voskian

[Selective, Redox-Mediated Pseudocapacitive Electrodes for Environmental Separations](#)

10:10 to 10:30

Ernesto Julio Calvo (INQUIMAE, University of Buenos Aires, Buenos Aires, Argentina), Florencia Marchini, Leandro Missoni, Maria del Pozo, Federico Williams

[A LiMn2O4-Polypyrrole battery system for the extraction of LiCl from natural brine](#)

10:30 to 10:50

Kyle Smith (Mechanical Science and Engineering, University of Illinois at Urbana-Champaign, Urbana, USA)

[Quantifying the Performance of Na-Ion Desalination \(NID\) Cells](#)

10:50 to 11:10

Coffee Break

s10 Electroactive, Functionalized and Nanostructured Materials and Composites: Modern Trends in Synthesis and Applications

Room : Europe

Chaired by: Mikhail Vorotyntsev

09:30 to 10:10 KEYNOTE

Mikhael Levi (Chemistry, Bar-Ilan University, Ramat-Gan, Israel), Doron Aurbach

[Electrochemical Quartz Crystal Microbalance with Dissipation Monitoring as a Unique Mesoscopic Tool for Studying Intercalation-Induced Deformations in Battery Electrodes](#)

10:10 to 10:30

Sébastien Moitzheim (Centre for Surface Chemistry and Catalysis, KU Leuven, Imec, Leuven, Belgium), Stefan De Gendt, Philippe M. Vereecken

[Mechanism of lithium-ion insertion/extraction into nanoscale amorphous TiO₂](#)

10:30 to 10:50

Daniel Scherson (Chemistry, Case Western Reserve University, Cleveland, USA), Adriel J.J. Jebaraj

[Electrocatalytic Effects Induced by Adsorbed Halides: The Reduction of Hexaquairon \(III\) in Aqueous Solutions](#)

10:50 to 11:10

Coffee Break

s13 Corrosion: The Electrochemistry of Corrosion and Approaches to Corrosion Protection

Room : Amazon

Chaired by: Herman Terry

09:30 to 09:50

M. Fatima Montemor (CQE-DEQ, Instituto Superior Tecnico, Lisboa, Portugal), Darya Snihirova, Sviatlana V. Lamaka

[Corrosion Inhibition Synergies on a Model Al-Cu-Mg Cell Studied by a Combination of Localized Scanning Electrochemical Techniques](#)

09:50 to 10:10

Nadine Pebere (CIRIMAT, CNRS, Toulouse, France)

[Influence of pH on the interactions of 8-hydroxyquinoline with pure Al surface: Electrochemical and DFT approaches](#)

10:10 to 10:30

Eduardo Ponzio (Physical Chemistry, Federal Fluminense University, Niterói, Brazil), Paulo Buzzetti, Caio Fernandes, Carlos Ramos, Valeria Teixeira, Anderson Rocha

[Inhibition effect of extract algae *Prasiola crispa* on corrosion of mild steel in 3.5% NaCl](#)

10:30 to 10:50

Matthias Uebel (Interface Chemistry and Surface Engineering, Max-Planck-Institut für Eisenforschung GmbH, Düsseldorf, Germany), Ashokanand Vimalanandan, Li-Ping Lv, Daniel Crespy, Michael Rohwerder

[Capsules with dual payloads for corrosion protection coatings – importance of the electronic coupling at the interface capsules/metal](#)

10:50 to 11:10

Coffee Break

s16 Physical and Interfacial Electrochemistry: Progress in Spectroscopy, Imaging and Theoretical Analysis

Room : Kilimanjaro

Chaired by: Zhong-Qun Tian

09:30 to 09:50

Michael Eikerling (Department of Chemistry, Simon Fraser University, Burnaby, Canada), Jun Huang, Ali Malek

[The Non-monotonic Charging Relation of Platinum: A Paradigm Change](#)

09:50 to 10:10

Elena Savinova (ICPEES UMR 7515, University of Strasbourg, Strasbourg, France), Viktoriia Saveleva, Li Wang, Aldo S. Gago, K. Andreas Friedrich, Spyridon Zafeiratos

[Oxygen Evolution Reaction at Ir_xRu_{1-x}O₂ Anodes: an Insight into the Ir Stabilization Effect from Near-Ambient Pressure XPS](#)

10:10 to 10:30

Hiroyuki Kawaaura (Toyota Central Research & Development Laboratories, Inc., Company, Nagakute, Japan), Masashi Harada, Yasuhito Kondo, Hiroki Kondo, Yoshitake Suganuma, Naoko Takahashi, Jun Suiyama, Yoshiki Seno, Norifumi Yamada

[In Situ Analysis of Surface Film Formation at Electrode/Electrolyte Interface by Neutron Reflectometry](#)

10:30 to 10:50

Ulmas E. Zhumaev (Molecular Spectroscopy, Max Planck Institute for Polymer Research, Mainz, Germany), Katrin F. Domke

[Unraveling CO Oscillation Mechanisms with Electrochemical Surface Plasmon Imaging](#)

10:50 to 11:10

Coffee Break

s19 Electrochemistry in Action

Room : Oceania Foyer

Chaired by: Plamen Atanassov

09:30 to 09:50 INVITED

Katherine Ayers (Engineering, Proton OnSite, Wallingford, USA)

[Renewable Hydrogen via Electrolysis: Opportunities and Challenges](#)

09:50 to 10:10 INVITED

Joosje van Bennekom (Metalconservation, Rijksmuseum Amsterdam, Amsterdam, Netherlands)

[A large centerpiece made by Wenzel Jamnitzer \(1549\): the removal of silver sulfide from fragile silver life-casts](#)

10:10 to 10:30 INVITED

Henri Barde (Power Systems Division, European Space Agency (ESA-ESTEC), Noordwijk, Netherlands)

[Electrochemical Energy Storage for Space Applications: Requirements, Constraints and Solutions](#)

10:30 to 10:50 INVITED

Thijs de Groot (Industrial Chemicals, AkzoNobel, Amsterdam, Netherlands)

[The chlor-alkali process: mature but not finalized](#)

10:50 to 11:10

Coffee Break

Thursday, 25 August 2016

ROOMS:		Mississippi		Yangtze 1		Oceania		King Willem Alexander		Oceania Foyer		Europe		Amazon		Everest		Kilimanjaro		Yangtze 2	
SYMPOSIUM	Symposium 2	Symposium 3	Symposium 6	Symposium 7	Symposium 4	Symposium 10	Symposium 20	Symposium 5	Symposium 16	Symposium 9	Plenary Lecture: Serge Lemay (King Willem Alexander)										
08:15 - 09:15																					
09:30 - 09:50	Leyla Soleymani	Ritu Katakya	Ruediger-A. Eichel	David Eisenberg	David Williams	S. Maldonado	Hubert Girault	Nikhil Malvanekar	Bernhard Gollas	Dennis Cardoen											
09:50 - 10:10		Jacek Lipkowski	Seitaro Ito	Claude Lamy	Taek Dong Chung	Laurent Bouffier	Eduardo Laborda	Korneel Rabaey	Julia Maibach	Jesus Palma											
10:10 - 10:30	Christophe Renault	Sarah Horswell	Sebastian Schmidt	Julian Behnken					Richard Nichols	Maarten Biesheuvel											
10:30 - 10:50	Ezo Nxusani				Coffee Break																
11:10 - 12:10					General Assembly (King Willem Alexander)																
					Lunch																
12:40 - 13:40	Division 4 Meeting	Division 1 Meeting	Division 6 Meeting		Division 7 Meeting	Division 5 Meeting	Division 3 Meeting														Division 2 Meeting
	Symposium 2	Symposium 7	Symposium 6	Symposium 7	Symposium 4	Symposium 10	Symposium 20	Symposium 12	Symposium 10	Symposium 18											
14:00 - 14:20	Frank Marken	James Weber	Vanessa Wood	Iryna Zenyuk	Jose M. Pingarron	Tom Breugelmanns	Chr. Coutanceau	Shanna Knights	Robert Hillman	Symposium 18											
14:20 - 14:40	Kristina Tschulik	Javier Monzo	Jens Glenneberg	Adam Weber	Chang Hyuck Choi	Andrew Ballantyne	Andrew Ballantyne		Christopher Brett	Kl. Jan Schouten											
14:40 - 15:00	Daniel Mandler	Thi Bich Hue Tran	François Ozanam	Yuya Yamashita	Stefania Rapino	Chr. Cachet-Vivier	Diogo Cabral	Takuya Hasegawa	Mikhail Vorotyntsev	Vincent Fourmond											
15:00 - 15:20	Hamid R. Zafarani	Thomas Gaumont	Hui Zhang	Erik Kjeang	Damien Arrigan	Stefan Barwe	Corinne Lagrost		Laurent Ruhlmann	Suman Bajracharya											
15:20 - 15:40	Magda Michalak	Kaido Tammeveski	Arnulf Latz	Julia Melke	Martin Bartosik	Marcel Risch	Veronika Zinovyeva	Akos Kriston	György Inzelt	Fred Lisdat											
15:40 - 16:00	Lisebo Phelane	Wen-Feng Lin	D. Guyomard	Nigel Brandon	Elena Ferapontova	Pa. Rodriguez	Liang Liu	Yuri Merla	Mark Burgess	Lo Gorton											
16:00 - 16:20	Dongping Zha	Nina Erini			A. M. Oliveira-Brett	Iwona Rutkowska	Marcin Opallo	Karine Gerardin	Alex. Nekrasov	Pawel J. Kulesza											
16:20 - 16:40					Coffee Break																
16:40 - 17:00	Tim Albrecht	Olga Kasian	Toshiyuki Momma	Marcel Risch	Koji Sode	Arian Hovestad	Sotiris Sotiriopoulos	Neus Sabate	S. Cord. de Torresi	Ana Sofia Varela											
17:00 - 17:20		Turgut Sönmez	Chr. Masquellier	Gw. Kéranguéven	Stephane Arbault	EI.A. M. Cherigui		Marc-Antoni Goulet	Gabriel Kopiec	Jonas Hereijgers											
17:20 - 17:40	Heinz-Bernh. Kraatz	Nathaniel Leonard	Nika Mahne	Kelsey Stoerzinger	Stephane Arbault	Sandro Cattarin	Na Tian	Christoph Grimmer	Martin Sjödin	Akira Yamaguchi											
17:40 - 18:00	Ja-an Annie Ho	Nick Daems	A. Bandarenka	Edson A. Ticianelli	Frédéric Lemaître	Marco Musiani	Simone Pokrant	Leo. Raymakers	Annette Delices	Dan Ren											
18:00 - 18:20	Cheryl M. Karman	Enrico Pizzutillo	Andrew Hector	Antoine Bonnefont	Renata Bilewicz	Ulrike Langklotz	Ernesto C. Pereira	Jochen Zausch	Felah I. Podvorica	Aaron Marshall											
18:20 - 18:40	Omotayo Arotiba	Valentina Perazzolo	Lukas Schafzahl	Justus Masa	Alice Solda	Shokoufeh Raastgar	Barbara Palyas	Niek de Klerk	Alison Downard	Séb. Garbaino											
19:00 -					Banquet - Grand Hotel Amrath Kurhaus The Hague																

Thursday, 25 August 2016, Morning

Plenary Lecture

Room : King Willem Alexander

Chaired by: Patrick Unwin

08:15 to 09:15

Serge Lemay (MESA+ Institute for Nanotechnology, University of Twente, Enschede, Netherlands)

[Electrochemical Nanofluidics: from Nanogaps to Nanocapacitors](#)

s02 Nanostructured Materials in Electroanalytical Chemistry

Room : Mississippi

Chaired by: Ja-an Annie Ho and Klaus Mathwig

09:30 to 10:10 KEYNOTE

Leyla Soleymani (Engineering Physics, McMaster University, Hamilton, Canada)

[Developing Electrochemical Biosensors on the Laboratory Benchtop](#)

10:10 to 10:30

Christophe Renault (Faculty of Science and Technology, University of Twente, Enschede, Netherlands),
Cecilia Laborde, Harrie Verhoeven, Maarten Jongsma, Frans Widdershoven, Serge Lemay

[Probing Capacitance Beyond the Double Layer with High-frequency Measurements](#)

10:30 to 10:50

Ezo Nxusani (Chemical Sciences, University of the Western Cape, Bellville, Cape Town, South Africa),
Emmanuel Iwuoha, Priscilla Baker

[Facile Label-free Iridium Selenide Quantum Dots based Electrochemical Immunosensor for the Detection of Cyanotoxin-Nodularin](#)

s03 New Approaches for Interfacing Electrochemistry and Biological Systems

Room : Yangtze 1

Chaired by: Joanna Juhaniewicz and Jacek Lipkowski

09:30 to 09:50 INVITED

Ritu Katakya (Chemistry, University of Durham, Durham, United Kingdom)

[Size, Charge and Time dependent penetration of metallic nanoparticles into lipid layers](#)

09:50 to 10:10

Jacek Lipkowski (Chemistry, University of Guelph, Guelph, Canada), Zhangfei Su, Muzaffar Shodiev

[PMIRRAS Studies of Potential Controlled Insertion of Alamethicin into a model biomembrane supported at the Au\(111\) electrode](#)

10:10 to 10:30

Sarah Horswell (School of Chemistry, University of Birmingham, Birmingham, United Kingdom), Philip Jemmett, Liam Cox

[A Spectroelectrochemical Study Comparing the Effect of Electric Field on Supported Sphingomyelin and Phosphatidylcholine Bilayers](#)

10:30 to 10:50 Coffee Break

s04 Electrochemical Approaches in Diseases and Human Health

Room : Oceania Foyer

Chaired by: Frédéric Lemaître and Woonsup Shin

09:30 to 10:10 KEYNOTE

David Williams (School of Chemical Sciences, University of Auckland, Auckland, New Zealand)

[The Design of Miniature Bioassay Devices](#)

10:10 to 10:30 INVITED

Taek Dong Chung (Chemistry, Seoul National University, Seoul, Korea), Inseong Hwang, Eun Joong Kim, Joohee Jeon

[Artificial Synapse between Live Neuron and Solid Electrode](#)

10:30 to 10:50 Coffee Break

s05 Current Progress in Microbial Electrochemical Technologies

Room : Everest

Chaired by: Xochitl Dominguez-Benetton and Korneel Rabaey

09:30 to 10:10 KEYNOTE

Nikhil Malvankar (Molecular Biophysics and Biochemistry, Yale University, West Haven, USA)

[New methods to measure electron transport along *Geobacter pili* suggests novel strategies to accelerate extracellular electron transfer](#)

10:10 to 10:30 INVITED

Korneel Rabaey (Center for Microbial Ecology and Technology, Ghent University, Ghent, Belgium)

[Interfacing microbial and electrochemical systems enhances product formation and extraction](#)

10:30 to 10:50 INVITED

Oskar Modin (Civil and Environmental Engineering, Chalmers University of Technology, Gothenburg, Sweden), Karin Karlfeldt Fedje

[Microbial Electrochemical Reactors for Metal Recovery from Leachates](#)

s06 Novel Materials and Devices for Energy Storage: Batteries for Tomorrow's World

Room : Oceania

Chaired by: Ruediger-A. Eichel and Stefano Passerini

09:30 to 09:50 INVITED

Ruediger-A. Eichel (Institute Energy and Climate Research (IEK-9), Forschungszentrum Juelich, Juelich, Germany)

['In-operando' investigating fundamental processes during charge/discharge cycling – lithium plating and dendrite growth](#)

09:50 to 10:10

Seitaro Ito (AR-3, Samsung R&D Institute Japan, Minoh, Japan), Ulderico Ulissi, Alberto Varzi, Ryo Omoda, Taku Watanabe, Yuichi Aihara, Stefano Passerini

[All Solid-State Lithium-Sulfur Battery with High Ion-Conducting \$\text{LiI-Li}_3\text{PS}_4\$ Glass Solid Electrolyte](#)

10:10 to 10:30

Sebastian Schmidt (Electrochemistry Laboratory, Paul Scherrer Institut, Villigen PSI, Switzerland), Sébastien Sallard, Petr Novák, Claire Villevieille

[Lithium Iron Methylene Diphosphonate, an Organic-Inorganic Hybrid Material for Positive and Negative Li-ion Battery Electrodes](#)

10:30 to 10:50 Coffee Break

s07 Novel Materials and Devices for Energy Conversion and Storage: Fuel Cells, Electrolysers, Regenerative Fuel Cells and Flow Batteries

Room : King Willem Alexander

Chaired by: Minoru Inaba

09:30 to 09:50

David Eisenberg (Van 't Hoff Institute for Molecular Science, University of Amsterdam, Amsterdam, Netherlands), Ning Yan, Wowa Stroek, Norbert J. Geels, Gadi Rothenberg

[A Practical Approach to Tunable Oxygen Reduction Catalysts from Mg-Based MOFs](#)

09:50 to 10:10 INVITED

Claude Lamy (Institut Européen des Membranes, CNRS-University of Montpellier, Montpellier, France)

[From Hydrogen Production by Water Electrolysis to its Utilization in a Proton Exchange Membrane Fuel Cell \(PEMFC\) or in a Solid Oxide Fuel Cell \(SOFC\): some considerations on the energy efficiencies](#)

10:10 to 10:30

Julian Behnken (Division Fuel Cells, NEXT ENERGY - EWE Research Centre for Energy Technology, Oldenburg, Germany), Alexander Dyck, Harun Tüysüz, Gunther Wittstock

[Coulometric Titration of Active Sites at Metal Oxide Based Fuel Cell Catalysts by Surface Interrogation Mode of SECM](#)

10:30 to 10:50 Coffee Break

s09 Capacitive Electrodes for Environmental Technology

Room : Yangtze 2

Chaired by: Ran Zhao

09:30 to 09:50

Dennis Cardoen (Separation and Conversion Technology Unit, VITO, Mol, Belgium), Senne De Peuter, Joost Helsen, Arne Verliefde

[The Role of Electrode Binder Dispersion and Ion Conductive Spacers in Ion Depletion during Capacitive Deionization](#)

09:50 to 10:10 INVITED

Jesús Palma (Multifunctional Nanocomposites Group, Institute IMDEA Energy, Getafe, Spain), Evgeny Senokos, Victor Reguero, Rebeca Marcilla

[Progress towards structural energy management using CNT fibre capacitive electrodes](#)

10:10 to 10:30

Maarten Biesheuvel (Wetsus, European Centre for Sustainable Water Technology, Leeuwarden, Netherlands), Jacopo Catalano

[Theory of ion and water flow through charged nanotubes](#)

10:30 to 10:50 Coffee Break

s10 Electroactive, Functionalized and Nanostructured Materials and Composites: Modern Trends in Synthesis and Applications

Room : Europe

Chaired by: Mikhael Levi

09:30 to 09:50 KEYNOTE

Stephen Maldonado (Chemistry, University of Michigan, Ann Arbor, USA)

[Electrochemical Liquid Liquid Solid Growth of Nanostructured Crystalline Semiconductors](#)

10:10 to 10:30

Laurent Bouffier (ISM, University of Bordeaux, Pessac, France), Gwendoline Tisserant, Julie Gillion, Jérémy Lannelongue, Zahra Fattah, Jérôme Roche, Stéphane Reculosa, Dodzi Zigah, Alexander Kuhn

[Fabrication of Chemical Gradients on Conducting Surfaces by Means of Bipolar Electrochemistry](#)

10:30 to 10:50

Coffee Break

s16 Physical and Interfacial Electrochemistry: Progress in Spectroscopy, Imaging and Theoretical Analysis

Room : Kilimanjaro

Chaired by: Katharina Krischer

09:30 to 09:50

Bernhard Gollas (Institute for Chemistry and Technology of Materials, Graz University of Technology, Graz, Austria), Luciana Vieira, David Fuchs, Robert Schennach, Bernhard C. Bayer

[Electrochemistry and Spectroelectrochemistry of Carbon Electrode/Deep Eutectic Solvent Interfaces](#)

09:50 to 10:10

Julia Maibach (Department of Chemistry, Ångström Laboratory, Uppsala University, Uppsala, Sweden), Fredrik Lindgren, Håkan Rensmo, Hans Siegbahn, Kristina Edström, Maria Hahlin

[How and Why Should We Look at the Buried Interface Between Lithium-Ion Battery Electrodes and the SEI?](#)

10:10 to 10:30

Richard Nichols (Department of Chemistry, The University of Liverpool, Liverpool, United Kingdom), Henry Osorio, Pilar Cea, Josef Gluyas, Frantisek Hartl, Samantha Catarelli, Simon Higgins, Edmund Leary, Paul Low, Santiago Martín, Joanne Tory, Jens Ulstrup, Andrea Vezzoli, David Milan, Qiang Zeng, Walther Schwarzacher, Bing-Wei Mao, Jia-Wei Yan, Jan Jeppesen, Jess Lycoops, Nicola Kay, Wolfgang Haiss, Gita Sedghi

[STM Studies in Ionic Liquids of Electrochemical Single Molecule Transistors and Molecular Wires](#)

10:30 to 10:50

Coffee Break

s20 General Session

Room : Amazon

Chaired by: Marcin Opallo and Sotiris Sotiropoulos

09:30 to 10:10 KEYNOTE

Hubert Girault (LEPA, EPFL, Sion, Switzerland), Véronique Amstutz, Alberto Battistel, Alejandro N. Colli, Christopher Raymond Dennison, Pekka Peljo, Heron Vrabel

[Redox electrocatalysis and indirect water electrolysis for charging electric vehicles](#)

10:10 to 10:30

Eduardo Laborda (Physical Chemistry, University of Murcia, Murcia, Spain), José María Gómez-Gil, Francisco Martínez-Ortiz

[Theoretical and Experimental Study of Multiple Chemical Equilibria Coupled to Multi-Electron Transfers by Voltammetric Techniques](#)

10:30 to 10:50

Coffee Break

Thursday, 25 August 2016, Afternoon

s02 Nanostructured Materials in Electroanalytical Chemistry

Room : Mississippi

Chaired by: Priscilla Baker and Jingyuan Chen

14:00 to 14:20 INVITED

Frank Marken (Chemistry, University of Bath, Bath, United Kingdom)

[Intrinsically Microporous Films and Membranes in Electrochemistry](#)

14:20 to 14:40

Kristina Tschulik (Chemistry, Micro-/ Nano-Electrochemistry, Ruhr-University Bochum, Bochum, Germany)

[Electrochemical Characterization of Bi-functional Core-Shell Nanomaterials using Ensemble and Single Nanoparticle Studies](#)

14:40 to 15:00

Daniel Mandler (Institute of Chemistry, The Hebrew University of Jerusalem, Jerusalem, Israel), Noga Ratner

[Electrochemical Detection of Low Concentrations of Mercury in Water Using Gold Nanoparticles](#)

15:00 to 15:20

Hamid Reza Zafarani (Chemical Engineering, TUDelft, Delft, Netherlands)

[Fabrication and application of new nanogap sensors](#)

15:20 to 15:40

Magdalena Michalak (Department of Electrode Processes, Institute of Physical Chemistry, Polish Academy of Sciences, Warsaw, Poland), Wojciech Nogala, Martin Jönsson-Niedziolka, Marcin Opallo

[Electrocatalytic Processes on Metallic Nanostructures Obtained by Localized Electrorefining using SECM](#)

15:40 to 16:00

Lisebo Phelane (Chemistry, University of the Western Cape, Cape Town, South Africa), Siyabulela Hamnca, Priscilla Baker, Emmanuel Iwuoha

[Electrochemical Recognition of Norfloxacin at Molecularly Imprinted Graphene Oxide Nanocomposites](#)

16:00 to 16:20

Dongping Zhan (College of Chemistry and Chemical Engineering, Xiamen University, Xiamen, China), Ding Yuan

[Scanning Photoelectrochemical Microscopy: from Reaction Kinetics to Combinatorial Screening](#)

16:20 to 16:40

Coffee Break

Chaired by: Qijin Chi and Bernhard Wolfm

16:40 to 17:20 KEYNOTE

Tim Albrecht (Department of Chemistry, Imperial College London, London, United Kingdom), Raquel Fraccari, Tina Leontidou, Philippa Nuttall, Giorgio Ferrari, Marco Carminati, Pietro Ciccarella, Kidan Lee, Ki-Bum Kim

[High-Bandwidth Electric Detection with Nanopores and Nanopipettes](#)

17:20 to 17:40 INVITED

Heinz-Bernhard Kraatz (Physical and Environmental Sciences, University of Toronto Scarborough, Toronto, Canada)

[Further Electrochemical Studies of Protein Kinase Catalyzed Phosphorylations](#)

17:40 to 18:00 INVITED

Ja-an Annie Ho (Department of Biochemical Science and Technology, National Taiwan University, Taipei, Taiwan), Wan-Yun Liu, Yi-feng Chang, Ying Li, Li-chen Wu

[Electrochemical Assay for the Human DNA Methyltransferase Activity](#)

18:00 to 18:20

Cheryl Maria Karman (Laboratoire Chimie Physique Microbiologie pour Environnement, Université de Lorraine-CNRS, UMR 7564, Villers-les Nancy, France), Alain Walcarius, Neus Vila

[Oriented and Nanostructured Ferrocene-Functionalized Silica-Based Thin Films for the Indirect Detection of Non-Electroactive Anions](#)

18:20 to 18:40

Omotayo Arotiba (Department of Applied Chemistry, University of Johannesburg, Johannesburg, South Africa), Narshone Soda, Wendy Maxakato

[A codeine aptasensor based on dendrimer-streptavidin supramolecular nano-architecture](#)

s04 Electrochemical Approaches in Diseases and Human Health

Room : Oceania Foyer

Chaired by: Fethi Bedioui and Taek Dong Chung

14:00 to 14:40 KEYNOTE

José M. Pingarrón (Analytical Chemistry, Complutense University of Madrid, Madrid, Spain), Susana Campuzano, Rebeca M. Torrente-Rodríguez, Víctor Ruiz-Valdepeñas Montiel

[Advanced Electrochemical Platforms for Single and Multiplexed Determination of Cancer Reporters](#)

14:40 to 15:00

Stefania Rapino (Department of Chemistry Giacomo Ciamician, University of Bologna, Bologna, Italy), Luca Bartolini, Francesca Lugli, Marco Dallavalle, Alice Soldà, Vincenzo Palermo, Pier Giuseppe Pelicci, Francesco Paolucci, Cristiano Albonetti, Francesco Zerbetto

[Living Cells meet Nanostructured and 2D Materials: a Reality Show filmed by Scanning ElectroChemical Microscopy](#)

15:00 to 15:20

Damien Arrigan (Chemistry / Nanochemistry Research Institute, Curtin University, Perth, Australia), Eva Alvarez de Eulate, Rashida Akter, Shane O'Sullivan, Lucia Gutiérrez

[Protein electrochemistry at aqueous-organogel interfaces – oligomer formation and biomarker detection](#)

15:20 to 15:40

Martin Bartosik (RECAMO, Masaryk Memorial Cancer Institute, Brno, Czech Republic), Roman Hrstka, Helena Durikova, Borivoj Vojtesek

[Electrochemistry of DNA for Molecular Oncology: Application to HPV Detection and DNA Methylation Studies](#)

15:40 to 16:00

Elena E. Ferapontova (Interdisciplinary Nanoscience Center (iNANO), Aarhus University, Aarhus, Denmark), Isabel Alvarez-Martos

[Specific Analysis of Dopamine in Whole Blood and Serum by Aptamer-Modified Electrodes](#)

16:00 to 16:20

Ana Maria Oliveira-Brett (Department of Chemistry, University of Coimbra, Coimbra, Portugal)

[Alzheimer's Disease Amyloid Beta Peptides in Vitro Oxidation and Time-Dependent Structural Modifications: AFM and Voltammetric Characterization](#)

16:20 to 16:40

Coffee Break

Chaired by: *Marilia Goulart and Lanqun Mao*

16:40 to 17:20 KEYNOTE

Koji Sode (Department of Biotechnology and Life Science, Tokyo University of Agriculture & Technology, Koganei, Japan)

[Development of the Next Generation Sensors for Self Monitoring of Blood Glucose and Continuous Glucose Monitoring Based on Direct Electron Transfer](#)

17:20 to 17:40 INVITED

Stephane Arbault (ISM CNRS UMR5255, University of Bordeaux, Pessac, France), Venkata S.R. Vajrala, Fadhila Sekli Belaïdi, Gabriel Lemercier, Dodzi Zigah, Neso Sojic, Jerome Launay, Pierre Temple-Boyer

[Microwell Array Integrating Ring Nanoelectrodes for The Monitoring of Metabolic Responses at Isolated Mitochondria](#)

17:40 to 18:00 INVITED

Frédéric Lemaître (Chemistry, Ecole Normale Supérieure, Paris, France), Manon Guille-Collignon, Yun Li, Cong Lu, Anne Vessières, Gérard Jaouen, Catherine Sella, Laurent Thouin, Christian Amatore

[Electrochemical Detection of Oxidative Stress – From the Single Platinized Ultramicroelectrode to Microsystems](#)

18:00 to 18:20

Renata Bilewicz (Chemistry, University of Warsaw, Warsaw, Poland), Elzbieta Jablonowska, Ewa Nazaruk, Dorota Matyszewska

[Lipidic Cubic Phase Carriers of Anticancer Drugs: Drug Release Profiles and Interactions with Phospholipid Membranes](#)

18:20 to 18:40

Alice Soldà (Department of Chemistry G. Ciamician, University of Bologna, Bologna, Italy), Stefania Rapino, Francesco Paolucci

[Electrochemical Study of Lactate in Cancer Research: from Single Living Cells to Tumor Tissues](#)

THURSDAY PM

s06 Novel Materials and Devices for Energy Storage: Batteries for Tomorrow's World

Room : Oceania

Chaired by: *Toshiyuki Momma and Vanessa Wood*

14:00 to 14:20 INVITED

Vanessa Wood (Information Technology and Electrical Engineering, ETH Zurich, Zurich, Switzerland)

[X-Ray Microscopies for Lithium Ion Battery Research](#)

14:20 to 14:40

Jens Glenneberg (Innovative Sensor and Functional Materials Research Group, University of Bremen, Bremen, Germany), Ingo Bardenhagen, Frederieke Langer, Robert Kun

[Direct deposition of thin film lithium ion batteries on flexible substrates](#)

14:40 to 15:00

François Ozanam (Laboratoire de Physique de la Matière Condensée, UMR 7643, Ecole Polytechnique, Palaiseau, France), Bon-Min Koo

[In situ ATR-FTIR analysis of methylated amorphous silicon as negative electrode material for Li-ion batteries](#)

15:00 to 15:20

Hui Zhang (Qian Xuesen Laboratory of Space Technology, China Academy of Space Technology (CAST), Beijing, China), Shimeng Hao, Ce Zhang, Wei Yao

[Effect of Li₂O-B₂O₃ Glass on Ionic Transfer of La_{2/3-x}Li_{3x}TiO₃ Solid Electrolyte and Interfacial Properties of Electrolyte/Electrode](#)

15:20 to 15:40

Arnulf Latz (Computational Electrochemistry, DLR and Helmholtz Institute Ulm, Ulm, Germany), Katharina Becker-Steinberger, Timo Danner, Stefanie Braun, Simon Schardt

[Origin of Interfacial Resistances in All-Solid-State Batteries](#)

15:40 to 16:20 KEYNOTE

Dominique Guyomard (ST2E, IMN, Nantes, France), Elise Deunf, Philippe Moreau, Eric Quarez, Franck Dolhem, Sofia Perticarari, Pablo Jimenez-Manero, Antonia Kotronia, Fabrice Odobel, Yann Pellegrin, Erol Blart, Joel Gaubicher, Philippe Poizot

[New materials for rechargeable organic batteries](#)

16:20 to 16:40

Coffee Break

16:40 to 17:00 INVITED

Toshiyuki Momma (Faculty of Science and Engineering, Waseda University, Shinjuku, Japan), Daikichi Mukoyama, Tokihiko Yokoshima, Hiroki Nara, Tetsuya Osaka

[Non-destructive Diagnosis of LIB with Tracing Elemental Reactions by Electrochemical Impedance Spectroscopy](#)

17:00 to 17:20 INVITED

Christian Masquelier (LRCS, Université de Picardie Jules Verne, Amiens, France), Laurence Croguennec, Mattéo Bianchini, Edouard Boivin, Jean-Marcel Ateba Mba, Thibault Broux, Fabien Lalère, Vincent Seznec, François Fauth, Hayan Chen, Olivier Mentré, Gwenaelle Rousse, Jean-Noel Chotard, Régnald David

[New Insights in Advanced Vanadium-containing Phosphates as Electrode Materials for Li and Na-ion Batteries](#)

17:20 to 17:40

Nika Mahne (Institute for Chemistry and Technology of Materials, Graz University of Technology, Graz, Austria), Sergey Borisov, Gernot A. Strohmeier, Bernhard Gollas, Stefan A. Freunberger

[New Insights into Parasitic Reactions in Aprotic Alkaline-Air Batteries](#)

17:40 to 18:00

Aliaksandr Bandarenka (Department of Physics, Technische Universität München, Garching bei München, Germany), Jeongsik Yun, Jonas Pfisterer

[How Simple are the Models of Na-intercalation in Aqueous Media?](#)

18:00 to 18:20

Andrew Hector (Chemistry, University of Southampton, Southampton, United Kingdom)

[Metal Nitride Electrodes for Sodium Batteries](#)

18:20 to 18:40

Lukas Schafzahl (Institute for Chemistry and Technology of Materials, Graz University of Technology, Graz, Austria)

[Electrolytes and Interfaces in Emerging Battery Chemistries](#)

s07 Novel Materials and Devices for Energy Conversion and Storage: Fuel Cells, Electrolysers, Regenerative Fuel Cells and Flow Batteries

Room : King Willem Alexander

Chaired by: Matthias Arenz

14:00 to 14:20

Iryna Zenyuk (Mechanical Engineering, Tufts University, Medford, USA), Andrew Shum, Kelsey B. Hatzell, Liam Connolly, Xianghui Xiao, Dilworth Y. Parkinson, Odne Burheim, Adam Weber

[Understanding Phase-Change-Induced Flow in PEFCs Through In-situ X-ray Computed Tomography](#)

14:20 to 14:40

Adam Weber (Energy Conversion Group, Lawrence Berkeley National Laboratory, Berkeley, USA), Anna Freiberg, Tobias Schuler, Franz Spingler, Michael Tucker

[Determination and Origin of Local Resistances in PEFC Catalyst Layers](#)

14:40 to 15:00

Yuya Yamashita (Interdisciplinary Graduate School of Medicine & Engineering, University of Yamanashi, Kofu, Japan), Shunsuke Itami, Taku Eguchi, Jun Takano, Katsuyoshi Kakinuma, Masanori Hara, Hiroyuki Uchida, Masahiro Watanabe, Akihiro Iiyama, Makoto Uchida

[Investigation of Cathode Catalyst Degradation under Hydrogen Passivation Startup and Shutdown Process for PEFCs](#)

15:00 to 15:20

Erik Kjeang (School of Mechatronic Systems Engineering, Simon Fraser University, Surrey, Canada), Yadvinder Singh, Francesco P. Orfino, Monica Dutta

[New Insight into Membrane Failures in Fuel Cells](#)

15:20 to 15:40

Julia Melke (Freiburger Materialforschungszentrum, Albert-Ludwigs-Universität Freiburg, Freiburg, Germany), Ditty Dixon, Helmut Ehrenberg, Christina Roth

[Increase of the ORR Activity and Stability of Carbon Supported Pt Nanoparticles by Tetradecyltrimethylammoniumbromide: An In-situ XAS Study](#)

15:40 to 16:20 KEYNOTE

Nigel Brandon (Sustainable Gas Institute, Imperial College, London, United Kingdom)

[Electrodes by design – towards the design of electrodes for electrochemical devices for energy applications](#)

16:20 to 16:40 Coffee Break

16:40 to 17:00 **HANS-JÜRGEN ENGELL PRIZE**

Marcel Risch (Institute of Materials Physics, University of Goettingen, Goettingen, Germany), Kelsey Stoerzinger, Tom Z. Regier, Derek Peak, Sayed Y. Sayed, Yang Shao-Horn

[Electrocatalytic Redox Processes of Transition Metal Oxides in Aqueous Media probed by Operando X-Ray Absorption Spectroscopy](#)

17:00 to 17:20

Gwénaëlle Kéranguéven (ICPEES, CNRS-UMR7515 - Université de Strasbourg, Strasbourg, France), Elena Savinova

[Study of ORR activity and oxide reducibility relationship on perovskite-carbon ISAC nanocomposites in alkaline media. A proof of carbon-oxide interactivity?](#)

17:20 to 17:40

Kelsey Stoerzinger (Materials Science and Engineering, Massachusetts Institute of Technology, Cambridge, USA), Wesley Hong, Livia Giordano, Yang Shao-Horn

[Molecular Insight into Oxygen Electrocatalysis on Transition Metal Oxides](#)

17:40 to 18:00

Edson A. Ticianelli (Departamento de Fisico Quimica, Instituto de Quimica de São Carlos - USP, São Carlos, Brazil), Ana M. Gomes-Marin, Jose L. Bott-Neto, Laudemir C. Varanda

[Electrocatalysis of the Hydrogen Evolution/Oxidation and Oxygen Reduction Reactions by Molybdenum Carbide-Based Particles](#)

18:00 to 18:20

Antoine Bonnefont (Institut de Chimie, CNRS-Université de Strasbourg, Strasbourg, France), Anna Ryabova, Galina Tsirlina, Elena Savinova

[Kinetic Modeling of the Oxygen and Hydrogen Peroxide Reactions on Manganese Oxides](#)

18:20 to 18:40

Justus Masa (Analytical Chemistry - Center for Electrochemical Sciences, Ruhr-University Bochum, Bochum, Germany), Ilya Sinev, Hemma Mistry, Beatriz Roldan Cuenya, Martin Muhler, Wolfgang Schuhmann

[Electrocatalysis of water splitting using metal borides and boron-doped metal nanoparticles: Hydrogen and oxygen evolution](#)

s07 Novel Materials and Devices for Energy Conversion and Storage: Fuel Cells, Electrolysers, Regenerative Fuel Cells and Flow Batteries

Room : Yangtze 1

Chaired by: Denis Kramer

14:00 to 14:20

James Weber (Department of Chemistry, University of Bath, Bath, United Kingdom), Andrew Wain, Heidi Piili, Anne Vuorema, Gary Attard, Frank Marken

[Residual Porosity of 3D-LAM-Printed Stainless Steel Electrodes Allows Galvanic Exchange Platinisation for Fuel Cell Applications](#)

14:20 to 14:40

Javier Monzó (School of Chemistry, University of Birmingham, Birmingham, United Kingdom), Dennis van der Vliet, Paramaconi Rodriguez

[X-ray Fluorescence for Elucidating the Degradation Mechanisms of the PEMFC Catalyst Layer](#)

14:40 to 15:00

Thi Bich Hue Tran (Physics Chemistry, European Membrane Institute - Montpellier University, Montpellier, France), Patrice Hugué, Stéfano Debate

[Operando Study of the Actual Hydration of the PEMFC Membrane by Raman Confocal Spectroscopy: Effect of the Gas Flow-Field Design](#)

15:00 to 15:20

Thomas Gaumont (LEMTA - Université de Lorraine - CEA Tech Lorraine, Vandoeuvre-lès-Nancy, France), Gael Maranzana, Olivier Lottin, Jérôme Dillet, Laure Guétaz, Joël Pauchet

[Study of Self-humidification of a PEMFC Operated With Dry Air](#)

15:20 to 15:40

Kaido Tammeveski (Institute of Chemistry, University of Tartu, Tartu, Estonia), Sander Ratso, Ivar Kruusenberg, Ave Sarapuu, Protima Rauwel, Rando Saar, Urmas Joost, Petri Kanninen, Tanja Kallio

[Enhanced Oxygen Reduction Reaction Activity of Iron, Cobalt-Containing Nitrogen-Doped Carbon Nanotubes for DMFC Application](#)

15:40 to 16:00

Wen-Feng Lin (Chemical Engineering, Loughborough University, Loughborough, United Kingdom), Ruirui Zhang, Xiao Lin, Ping Wang, Hancun Wang, Tian Sheng, Christopher Hardacre, P. Hu, Shi-Gang Sun

[Low Cost High Performance Nanocatalysts for Direct Ethanol Fuel Cell Application: Catalyst Development and Reaction Mechanism Studied by in-situ FTIR Spectroscopy and DFT Atomistic Modeling](#)

16:00 to 16:20

Nina Erini (Research Group: Catalysts and Electrocatalysts, Technical University Darmstadt, Darmstadt, Germany), Ulrike I. Kramm

[Carbon supported IrSn alloys for the application as anode catalysts in fuel cells](#)

16:20 to 16:40

Coffee Break

16:40 to 17:00

Olga Kasian (Department of Interface Chemistry and Surface Science, Max-Planck-Institut für Eisenforschung GmbH, Dusseldorf, Germany), Serhiy Cherevko, Simon Geiger, George Polymeros, Alan Savan, Alfred Ludwig, Karl J.J. Mayrhofer

[RuO₂-IrO₂ Mixed Oxide Anodes for Oxygen Evolution Reaction: the Challenge in Stability Improvement](#)

17:00 to 17:20

Turgut Sönmez (Department of Chemistry, University of Southampton, Southampton, United Kingdom), Andrea Russell, Derek Pletcher

[The Effect of Preparation Method on the ORR Activity of Spinel MnCo₂O₄ in Alkaline Electrolyte](#)

17:20 to 17:40

Nathaniel Leonard (Chemistry, Technical University of Berlin, Berlin, Germany), Julian Steinberg, Fang Luo, Peter Strasser

[Impact of Secondary Nitrogen Precursor on Non-Precious Metal Catalysts for Oxygen Reduction Reaction](#)

17:40 to 18:00

Nick Daems (Centre for Surface Chemistry and Catalysis, K.U. Leuven, Heverlee, Belgium), Ivo Vankelecom, Paolo Pescarmona

[Doped Ordered Mesoporous Carbons as Electrocatalysts for the Cogeneration of Electricity and Aniline](#)

18:00 to 18:20

Enrico Pizzutilo (Interface Chemistry and Surface Engineering, Max-Planck-Institut für Eisenforschung GmbH, Dusseldorf, Germany), Simon Freakley, Simon Geiger, George Polymeros, Claudio Baldizzone, Graham J. Hutchings, Karl J.J. Mayrhofer

[Gold-Palladium Catalyst Degradation and its Consequences for the H₂O₂ Selectivity](#)

18:20 to 18:40

Valentina Perazzolo (Department of Chemical Science, University of Padova, Padova, Italy), Robin Astier-Perret, Christian Durante, Isotta Cerri, Armando Gennaro

[Controlled size Pt-Nanoparticles on N- and S-Doped Mesoporous Carbon as Cathode Materials for PEMFCs](#)

s10 Electroactive, Functionalized and Nanostructured Materials and Composites: Modern Trends in Synthesis and Applications

Room : Europe

Chaired by: Alessandro Boni and Arjan Hovestad

14:00 to 14:20

Tom Breugelmans (Faculty of Applied Engineering, University of Antwerp, Wilrijk, Belgium), Bart Geboes, Jon Ustarroz, Kadir Sentosun, Hans Vanrompay, Sara Bals, Annick Hubin

[Electrochemical behavior of electrodeposited nanoporous Pt catalysts for the Oxygen Reduction Reaction](#)

14:20 to 14:40

Chang Hyuck Choi (Department of Interface Chemistry and Surface Engineering, Max-Planck-Institute, Dusseldorf, Germany), Karl J.J. Mayrhofer

[Tuning Selectivity of Electrochemical Reactions by Atomically Site-Isolated Platinum Catalyst](#)

14:40 to 15:00

Christine Cachet-Vivier (Institut de Chimie et des Matériaux Paris-Est, Université Paris-Est Créteil - CNRS, Thiais, France), Peyman Mirzaei, Stéphane Bastide, Claudia Zlotea, Encarnacion Torralba Peñalver, Michel Laurent, Michel Latroche

[Cu-Rh nanoparticles/carbon composites for electroreduction of nitrates](#)

15:00 to 15:20

Stefan Barwe (Analytical Chemistry, Center for Electrochemical Sciences (Ruhr-Universität Bochum, Bochum, Germany), Corina Andronesco, Edgar Ventosa, Justus Masa, Bharathi Konkana, Eugeniu Vasile, Wolfgang Schuhmann

[Synthesis of NiFe Layered Double Hydroxides and Carbon Nanocomposites with High Electrocatalytic Activity and Enhanced Stability for the Oxygen Evolution Reaction](#)

15:20 to 15:40

Marcel Risch (Institute of Materials Physics, University of Göttingen, Göttingen, Germany)

[From Amorphous to Epitaxial Oxides: Molecular Insight Into Oxygen Electrocatalysis](#)

15:40 to 16:00

Paramaconi Rodriguez (School of Chemistry, University of Birmingham, Birmingham, United Kingdom), Javier Monzó, Adam Kolodziej, Mathew Kromer, Sara Morandi, Zachary Gossage, Alessandro Minguzzi, Sandra Rondinini, Joaquin Rodriguez Lopez

[Photocatalytic Nanoparticles Obtained via the Cathodic Corrosion Method and Electrochemical Imaging of their Water Oxidation Reactivity](#)

16:00 to 16:20

Iwona A. Rutkowska (Department of Chemistry, University of Warsaw, Warsaw, Poland), Anna Wadas, Pawel J. Kulesza

[Electrocatalytic oxidations at noble metal nanoparticles supported onto structured films of highly acidic mixed metal \(W, Zr\) oxides](#)

16:20 to 16:40

Coffee Break

Chaired by: Stanko Brankovic and Ulrike Langklotz

16:40 to 17:00

Arjan Hovestad (Solliance, TNO, Eindhoven, Netherlands), Younes Aouj, Joop van Deelen, Peter Bressers

[Electrodeposition of Ni Grids on ZnO: Al as Highly Conductive Hybrid Front Contacts for Thin Film Solar Cells](#)

17:00 to 17:20

El Amine Mernissi Cherigui (Materials and Chemistry (MACH), Vrije Universiteit Brussel (VUB), Brussels, Belgium), Pieter Bouckenoge, Kadir Sentosun, Hans Vanrompay, Sara Bals, Jon Ustarroz, Herman Terryn

[Electrodeposition of Nickel Nanostructures from Deep Eutectic Solvents](#)

17:20 to 17:40

Sandro Cattarin (IENI - Institute for Energetics and Interphases, CNR - National Research Council of Italy, Padua, Italy), Luca Mattarozzi, Nicola Comisso, Paolo Guerriero, Marco Musiani, Enrico Verlato

[Porous Nanostructured Ag Electrodes for Sensitive Electrochemical Detection of Hydrogen Peroxide](#)

17:40 to 18:00

Marco Musiani (IENI, CNR, Padova, Italy), Nicola Comisso, Sandro Cattarin, Paolo Guerriero, Luca Mattarozzi, Enrico Verlato

[Electrochemical Behaviour of Porous PbO₂ Layers Prepared by Oxygen Bubble Templated Anodic Deposition](#)

18:00 to 18:20

Ulrike Langklotz (Institute of Material Science, TU Dresden, Dresden, Germany), Mathias Weiser, Tobias Lein, Andreas Krause, Alexander Michaelis

[Silicon-Nanowire anodes for lithium batteries synthesized from galvanic gold nanoparticles](#)

18:20 to 18:40

Shokoufeh Rastgar (Institute of Chemistry, Carl von Ossietzky University of Oldenburg, Oldenburg, Germany), Gunther Wittstock

[Novel Insight to In-situ Sensing of Visible-Light-Driven Water Oxidation Intermediates at Polarized Liquid-Liquid Interfaces](#)

s10 Electroactive, Functionalized and Nanostructured Materials and Composites: Modern Trends in Synthesis and Applications

Room : Kilimanjaro

Chaired by: Susana Cordoba de Torresi and Annette Delices

14:00 to 14:20 INVITED

Robert Hillman (Chemistry, University of Leicester, Leicester, United Kingdom), Asuman Unal, Abdulcabbar Yavuz, Karl S. Ryder

[Electrochemical Defluoridation of Water Using Electroactive Copolymer Films Based on Polyaniline and Derivatives](#)

14:20 to 14:40

Christopher Brett (Department of Chemistry, University of Coimbra, Coimbra, Portugal), Krishna Prathish, Madalina Barsan

[Deep eutectic solvents as a strategy for preparation of electroactive polymer-modified electrodes](#)

14:40 to 15:00

Mikhail Vorotyntsev (Department of Technology of Polymer Composite Paint, D.I. Mendeleev University of Chemical Technology of Russia, Moscow, Russia), Dmitry Konev, Olga Istakova

[Synthesis of Cobalt \(II\) Polyporphine Films by Electrochemical Method](#)

15:00 to 15:20

Laurent Ruhlmann (Chemistry, University of Strasbourg, Strasbourg, France), Jean-Daniel Compain, Zhaohui Huo, Iban Azcarate, Emmanuel Lacôte, Bernold Hassenknopf, Christophe Bucher

[Design of New Porphyrin-Polyoxometalate Electropolymers for the Photoelectrochemical Energy Conversion](#)

15:20 to 15:40

György Inzelt (Physical Chemistry, Eötvös Loránd University, Budapest, Hungary)

[Electronanogravimetric Studies of Poly\(copper phthalocyanine\)](#)

15:40 to 16:00

Mark Burgess (Chemistry, University of Illinois at Urbana-Champaign, Urbana, USA), Kenneth Hernandez-Burgos, Etienne Chenard, Burton Simpson, Kevin J. Cheng, Jeffrey S. Moore

[Elucidating the Reactivity and Solution Dynamics of Redox Active Polymers](#)

16:00 to 16:20

Alexander Nekrasov (Russian Academy of Sciences, A.N. Frumkin Institute of Physical Chemistry and Electrochem, Moscow, Russia), Olga Iakobson, Varvara Cabanova, Vladimir Tverskoy, Anatoly Vannikov, Oxana Gribkova

[The Role of Polyelectrolyte Structure in 3,4-ethylenedioxythiophene Electropolymerization](#)

16:20 to 16:40 Coffee Break

Chaired by: Mark Burgess and Robert Hillman

16:40 to 17:00

Susana Cordoba de Torresi (Instituto de Quimica, Universidade de São Paulo, São Paulo, Brazil), Jadielson L. Antonio, Tom Lindfors

[Electro-controlled swelling and water uptake of a 3-D conducting polypyrrole hydrogel](#)

17:00 to 17:20

Gabriel Kopiec (Analytical Chemistry - Center for Electrochemical Sciences, Ruhr-University Bochum, Bochum, Germany), Stefanie Stapf, Nicolas Plumeré

[Tuning the Solvation State of Redox Hydrogels for Adjusting the Redox Potential toward Reversible Catalysis](#)

17:20 to 17:40

Martin Sjödin (Dept. of Engineering Sciences, Uppsala University, Uppsala, Sweden), Hao Huang, Rikard Emanuelsson, Mia Sterby, Xiao Huang, Li Yang, Christoffer Karlsson, Adolf Gogoll, Maria Strømme

[Conducting Redox Polymers for Secondary Batteries](#)

17:40 to 18:00

Annette Delices (Chemistry ITODYS Laboratory, Université Paris Diderot Sorbonne Paris Cité, Paris, France), Christian Perruchot, Chang-Zhi Dong, Anders Hagfeldt, Jinbao Zhang, Nick Vlachopoulos, Mohamed Jouini

[Charge Transfer Optimization at the Interface of Covalently Linked Dye/HTM in Solid-State Dye Sensitized Solar Cells](#)

18:00 to 18:20

Fetah I. Podvorica (ITODYS, Université Paris-Diderot, Paris, France), Dardan Hetemi, Catherine Combellas, Frederic Kanoufi, Jean Pinson

[Grafting of thin alkyl films on carbon, metal and polymer surfaces via a radical crossover reaction](#)

18:20 to 18:40

Alison Downard (Department of Chemistry, University of Canterbury, Christchurch, New Zealand), Lita Lee, Deborah Crittenden, Nathaniel Gunby

[Covalently bound mixed monolayers on carbon: experiment and computation](#)

s12 EC Power Sources: Principles of Materials, Design and Operation

Room : Everest

Chaired by: Erik Kjeang

14:00 to 14:40 KEYNOTE

Shanna Knights (Research, Ballard Power Systems, Burnaby, Canada)

[Fuel Cell Commercialization: Progress and Technology Directions](#)

14:40 to 15:20 KEYNOTE

Takuya Hasegawa (Nissan Research Center, Nissan Motor Co., Ltd., Yokosuka, Japan), Takuma Suzuki, Yoda Kazuyuki, Balaji Kalyanarangan

[D Parts Revolution - How Electrochemical Power Generation Devices Can Be Less Costly by Fully Employing Roll-to-Roll Process](#)

15:20 to 15:40

Akos Kriston (Institute for Energy and Transport, European Commission DG JRC, Petten, Netherlands), Vanesa Ruiz, Theodora Kosmidou, Jürgen Ungeheuer, Harry Döring, Benjamin Fritsch, Andreas Pfrang, Lois Boon-Brett

[Evaluation of External Short Circuit Performance of Li-ion Batteries for the Global Technical Regulation of Electric Vehicle Safety](#)

15:40 to 16:00

Yuri Merla (Mechanical Engineering, Imperial College London, London, United Kingdom), Ian Hunt, Yan Zhao, Marie-Therese von Srbik, Monica Marinescu, Vladimir Yufit, Billy Wu, Ricardo Martinez-Botas, Nigel Brandon, Gregory Offer

[Detecting, diagnosing and controlling degradation in lithium ion battery pack](#)

16:00 to 16:20

Karine Gerardin (Syspol, LRGP - Univ. Lorraine - CNRS, Nancy, France), Stéphane Raël, Caroline Bonnet, Jonas Kerwald, François Lapique

[Direct hybridization of PEMFC by supercapacitors for higher durability and more efficient use of hydrogen](#)

16:20 to 16:40

Coffee Break

16:40 to 17:00

Neus Sabate (Micro and Nanosystems, Barcelona Microelectronics Institute (IMB-CNM-CSIC), Bellaterra-Barcelona, Spain)

[Paper-Based Fuel Cells and Batteries as Sustainable Power Sources for a New Generation of Disposable Analytical Devices](#)

17:00 to 17:20

Marc-Antoni Goulet (School of Mechatronic Systems Engineering, Simon Fraser University, Surrey, Canada), Erik Kjeang

[Compact Electrochemical Flow Cell with Record Power Density](#)

17:20 to 17:40

Christoph Grimmer (Institute of Chemical Engineering and Environmental Technology, Graz University of Technology, Graz, Austria), Robert Zacharias, Maximilian Grandi, Viktor Hacker

[A Direct Borohydride Fuel Cell Without Hydrogen Release Side Reaction](#)

17:40 to 18:00

Leonard Raymakers (Engineering, HyET, Arnhem, Netherlands), Sander Grootjes, Harm Vlap, Peter Bouwman

[Project PurifHy – Selective Electrochemical Extraction of Hydrogen](#)

18:00 to 18:20

Jochen Zausch (Flow and Material Simulation, Fraunhofer-Institute for Industrial Mathematics, Kaiserslautern, Germany), Torben Prill, Arnulf Latz

[Modeling of lithium ion batteries on micro and cell scale with emphasis on thermal and mechanical coupling](#)

18:20 to 18:40

Niek de Klerk (FAME, TU Delft, Delft, Netherlands), Alexandros Vasileiadis, Raymond B. Smith, Martin Z. Bazant, Marnix Wagemaker

[Explaining Key Properties of Lithiating TiO₂-Anatase: A Phase Field Model for Materials with Multiple Phases](#)

s18 Electrochemistry, Photoelectrochemistry and Bioelectrochemistry of Artificial Photosynthesis: Recent Advances in CO₂ Conversion to Products

Room : Yangtze 2

Chaired by: Fred Lisdat and Deepak Pant

14:00 to 14:40 KEYNOTE

Klaas Jan Schouten (New Chemistries, Avantium, Amsterdam, Netherlands), Jan Kees van der Waal, Gert-Jan Gruter

[Electrochemistry in a Bio Refinery](#)

14:40 to 15:00

Vincent Fourmond (Laboratoire de Bioénergétique et Ingénierie des Protéines, Aix-Marseille Université/CNRS, Marseille, France), Meriem Merrouch, Jessica Hadj-Saïd, Lilith Domnik, Gabriel Kopiec, Stefanie Stapf, Nicolas Plumeré, Adrian Ruff, Wolfgang Schuhmann, Sébastien Dementin, Christophe Léger

[Aerobic biological reduction of CO₂](#)

15:00 to 15:20

Suman Bajracharya (Separation and Conversion Technology Unit, VITO, Flemish Institute for Technological Research, Mol, Belgium), Karolien Vanbroekhoven, Cees Buisman, Deepak Pant, David Strik

[Bioelectrochemical CO₂ Reduction integrated with Product Separation: a Prospect for Future Application](#)

15:20 to 15:40

Fred Lisdat (Biosystems Technology, Institute of Applied Life Sciences, Technical University Wildau, Wildau, Germany), Sven C. Feifel, Kai Stieger

[Photobioelectrodes based on the combination of photosystem I with graphene layers](#)

15:40 to 16:00

Lo Gorton (Dept. of Analytical Chemistry, Biochemistry and Structural Biology, Lund University, Lund, Sweden), Kamrul Hasan, Galina Pankratova, Eva Sperling, Donal Leech, Peter O'Conghaile, Michael A. Packer

[Electrochemical Communication between Photosynthetic Membranes/Cells and Electrodes for Harvesting Solar Energy](#)

16:00 to 16:20

Pawel J. Kulesza (Department of Chemistry, University of Warsaw, Warsaw, Poland)

[Structure, function and reactivity of hybrid materials for electrocatalytic, bioelectrocatalytic and photoelectrochemical reduction of carbon dioxide](#)

16:20 to 16:40 Coffee Break

Chaired by: *Lo Gorton and Pawel J. Kulesza*

16:40 to 17:00

Ana Sofia Varela (Department of Chemistry, Technical University Berlin, Berlin, Germany), Wen Ju, Xingly Wang, Timmey Moeller, Hemma Mistry, Beatriz Roldan, Peter Strasser

[Low Cost Material as Selective Catalyst for CO₂ Electro-reduction](#)

17:00 to 17:20

Jonas Hereijgers (Advanced Reactor Technology, University of Antwerp, Antwerp, Belgium), Robbe Verweken, Danny Pauwels, Vera Meynen, Tom Breugelmans

[On the Geometrical Features of the Electrolyzer for CO₂ Reduction](#)

17:20 to 17:40

Akira Yamaguchi (Center for Sustainable Resource Science, RIKEN, Wako, Japan), Hiroataka Kakizaki, Shogo Mori, Kazuhito Hashimoto, Ryuhei Nakamura

[Development of MnO₂-based water oxidation catalysts focusing on the redox properties of Mn](#)

17:40 to 18:00

Dan Ren (Chemistry, National University of Singapore, Singapore, Singapore), Boon Siang Yeo

[Efficient and Stable Electrochemical Reduction of Carbon Dioxide to n-Propanol on Agglomerated Cu Nanocrystals](#)

18:00 to 18:20

Aaron Marshall (Department of Chemical and Process Engineering, University of Canterbury, Christchurch, New Zealand), Calvin Lim, David Harrington

[Electrochemical reduction of carbon dioxide on copper cathodes](#)

18:20 to 18:40

Sébastien Garbarino (INRS, Varennes, Canada), Claudie Roy, Daniel Guay

[Dynamic Hydrogen Bubble Templating of Cu electrodes: Enhanced CO Reduction Electrocatalysts](#)

s20 General Session

Room : Amazon

Chaired by: *Corinne Lagrost; Roberto M. Torresi*

14:00 to 14:20 INVITED

Christophe Coutanceau (IC2MP, University of Poitiers, Poitiers, France), Florent Boissou, Pamela Michaud, Stéphane Baranton, Karine Vigier

[Electrochemistry in deep eutectic solvents](#)

14:20 to 14:40

Andrew Ballantyne (Department of Chemistry, University of Leicester, Leicester, United Kingdom), Gregory Forrest, Gero Frisch, Jennifer Hartley, Karl S. Ryder, Alex Goddard

[Immersion Coatings of Au and Pd from Deep Eutectic Solvents: Influence of Speciation on Galvanic Processes](#)

14:40 to 15:00

Diogo Cabral (School of Chemistry, Monash University, Clayton, Australia), Douglas MacFarlane

[Electrochemistry of tris\(2,2'-bipyridine\) complexes of cobalt \(II\), nickel \(II\) and iron \(II\) in ionic liquids and aprotic solvents](#)

15:00 to 15:20 INVITED

Corinne Lagrost (Institut des Sciences Chimiques de Rennes, CNRS, University of Rennes 1, Rennes, France), Soizic Chevance, Vincent Claireaux, Johanna Loosveldt, Olivier Delalande

[Direct Electrochemistry of Redox Hemoproteins in a Water-Imidazolium-based Ionic Liquids Mixture. A "Tin Opener" Effect](#)

15:20 to 15:40

Veronika Zinovyeva (Chemistry Department / IPN Orsay, University of Paris-Sud, Orsay, France), Servando López-León, Céline Cannes, Claire Le Naour, Jacques de Sanoit, Céline Gesset, François Brisset

[Nanostructured Lanthanum Thin Films: Electrochemical Preparation in Ionic Liquid Medium](#)

15:40 to 16:00

Liang Liu (LCPME, UMR 7564, CNRS-Université de Lorraine, Villers-lès-Nancy, France), Shai Yellinek, Ido Valdinger, Daniel Mandler

[Electrochemical Reduction of Indium Tin Oxide \(ITO\): Inhibition and Application](#)

16:00 to 16:20

Marcin Opallo (Department of Electrode Processes, Institute of Physical Chemistry PAS, Warszawa, Poland), Justyna Jedraszko, Wojciech Nogala, Wojciech Adamiak, Olga Krysiak, Saustin Dongmo, Gunther Wittstock, Hubert Girault

[\(Electro\)catalytic H₂O₂ and H₂ Generation at Organic Liquid/Water Interface: Solvent and Electrolyte Effect, SECM Detection](#)

16:20 to 16:40

Coffee Break

16:40 to 17:20 KEYNOTE

Sotiris Sotiropoulos (Chemistry, Aristotle University of Thessaloniki, Thessaloniki, Greece)

[Galvanic replacement processes in electrocatalysis and metal ion removal applications](#)

17:20 to 17:40

Na Tian (Chemistry Department, Xiamen University, Xiamen, China), Yan-Fen Lin, Tian Sheng, Zhi-You Zhou, Shi-Gang Sun

[Depositing Pt on Pd Tetrahedral Nanoparticles and Their Enhanced Catalytic Activity for Ethanol Electrooxidation](#)

17:40 to 18:00

Simone Pokrant (Materials for Energy Conversion, Empa, Dübendorf, Switzerland), Jingshan Luo, Steve Landsmann, Stefan Dilger, Michael Graetzel, Anke Weidenkaff

[Solar watersplitting via an artificial leaf: Photoanode/photocathode tandem device in stacked configuration](#)

18:00 to 18:20 INVITED

Ernesto C. Pereira (Chemistry, Federal University of Sao Carlos, Sao Carlos, Brazil), Fernando C. Moraes, Roger Gonçalves

[Investigation of graphene properties and its use as electrode material](#)

18:20 to 18:40 INVITED

Barbara Palys (Department of Chemistry, Warsaw University, Warsaw, Poland), Anna Jablonska, Agnieszka Swietlikowska, Piotr Olejnik, Sylwia Berbec

[Electrocatalytic Activity of Horseradish Peroxidase on Polyaniline Nanotubes and Hydrogels with and without Graphene Oxide](#)

Friday, 26 August 2016

ROOMS:	Mississippi	Yangtze 1	Oceania	King Willem Alexander	Oceania Foyer	Europe	Amazon	Everest	Kilimanjaro	Yangtze 2
SYMPOSIUM	Symposium 2	Symposium 7	Symposium 6	Symposium 7	Symposium 6	Symposium 10	Symposium 20	Symposium 13	Symposium 10	Symposium 18
08:15 - 09:15			Plenary Lecture: Yuri Pleskov (King Willem Alexander)							
09:30 - 09:50	Rabah Boukherroub	Véronique Amstutz	Samuel Fitch	Minoru Inaba	C-Hsien Chuang	Patrik Schmuki	Ramona Gutkowski	Sigrid Benfer	Olle Inganas	Teresa Andreu
09:50 - 10:10	Xing-Hua Xia	K. Nagasawa	Xi Jiang		Ce Zhang	Grzegorz Sulka	Peter Knittel	Christian Dieleman		
10:10 - 10:30	James Rohan	Takuto Kushi	Yuhui Chen	Frédéric Maillard	Bettina Grumm	Alessandro Boni	Nejc Hodni	Kang Shi	Stanko Brankovic	Carles Ros
10:30 - 10:50			Coffee Break							
10:50 - 11:10	Vladimir M. Mirsky	E. G.ar-Quismondo	Monica Marinescu	Hiroyuki Uchida	Philip Reinsberg	Magda. Skompska	Kristel Jukk	Wan-Zhen Hsieh	Salvatore Piazza	J-Daniel Compain
11:10 - 11:30	Paolo Bertoncello	Pekka Peljo	Frederieke Langer	Ernesto Gonzalez	J-P Pereira-Ramos	Balazs Endrodi	E. Kibena-Poldsepp	Thomas Hersbach	A. Vaskevich	Min-Kyu Son
11:30 - 11:50	Angelika Holzinger	Aurore Lé	Irene Ruggeri	Matija Gatalo	Ana Lopez-Cudero	Neus Vila	S. A. Bin Shafiee	S.-Zhu Kure-Chu	Masa-aki Haga	Youngkook Kwon
11:50 - 12:10	Minkyung Kang	J. Vazquez-Galvan	Yuki Orikasa	Simon A. Tschupp	Tina Nestler	Minwei Zhang	Kangwoo Cho	Joerg Posdorfer	Giovanni Valenti	Fengwang Li
12:15 - 12:30			Closing Ceremony (King Willem Alexander)							

Friday, 26 August 2016, Morning

Plenary Lecture

Room : King Willem Alexander

Chaired by: Zhong-Qun Tian

08:15 to 09:15 **FRUMKIN MEMORIAL MEDAL**

Yuri Pleskov (Physical Electrochemistry Lab., Frumkin Institute of Physical Chemistry and Electrochemistry, Moscow, Russia)

[Alexander Frumkin and the Electrochemistry of Diamond in My Life](#)

s02 Nanostructured Materials in Electroanalytical Chemistry

Room : Mississippi

Chaired by: Karolien De Wael, Kosuke Ino and Kristina Tschulik

09:30 to 09:50 INVITED

Rabah Boukherroub (Institute of Electronics, Microelectronics & Nanotechnology, CNRS & Lille1 University, Villeneuve d'Ascq, France), Florina Teodorescu, Hakim Belkhalifa, Gurvan Quéniat, Amar Abderrahmani, Sabine Szunerits

[Nanocomposites of graphene for electrochemical sensing and controlled release of biomolecules](#)

09:50 to 10:10

Xing-Hua Xia (School of Chemistry and Chemical Engineering, Nanjing University, Nanjing, China), Chen Wang, Yi Shi

[Plasmonics accelerated electrocatalysis for detection of electroactive biomolecules](#)

10:10 to 10:30

James Rohan (Electrochemical Materials and Energy Group, Tyndall National Institute, Cork, Ireland), Lorraine Nagle, Ronan MacLoughlin, Ian Seymour

[Fabrication and Optimisation of Nanoporous Gold at Microdisc Electrode Arrays for Electrochemical Sensing Applications](#)

10:30 to 10:50

Coffee Break

10:50 to 11:10 INVITED

Vladimir M. Mirsky (Institute of Biotechnology, Department of Nanobiotechnology, BTU Cottbus-Senftenberg, Senftenberg, Germany), Shavkat Nizamov, Olga Kasian

[Plasmonic detection of electrochemical conversion of single nanoparticles](#)

11:10 to 11:30

Paolo Bertonecello (College of Engineering, Swansea University, Swansea, United Kingdom), Thomas Ross, Sandra Aldave Hernandez, Robert Kaspar, Michael Letterio, Yushan Yan

[Anionic-Exchange Ionomer-Chemically Modified Electrodes for Electroanalytical Applications](#)

11:30 to 11:50

Angelika Holzinger (Institute of Analytical and Bioanalytical Chemistry, Ulm University, Ulm, Germany), Peter Knittel, Yang Liu, Damien Arrigan, Christine Kranz

[Investigations of Nanopore Arrays for Liquid/Liquid Interfaces by Scanning Probe Techniques](#)

11:50 to 12:10

Minkyung Kang (Department of Chemistry, The University of Warwick, Coventry, United Kingdom), David Perry, Dmitry Momotenko, Ashley Page, Patrick Unwin

[Scanning electrochemical probe microscopy of single nanoparticle electrochemistry](#)

s06 Novel Materials and Devices for Energy Storage: Batteries for Tomorrow's World

Room : Oceania

Chaired by: Daniel Buchholz and Monica Marinescu

09:30 to 09:50

Samuel Fitch (Chemistry, University of Southampton, Southampton, United Kingdom), Xianji Li, Andrew Hector, John Owen, Imran Shah

[Evaluation of tin \(IV\) nitride as a negative electrode material for Li-ion and Na-ion batteries.](#)

09:50 to 10:10

Xi Jiang (Department of Chemical & Biomolecular Engineering, National University of Singapore, Singapore, Singapore), Liuqing Yang, Bo Ding, Baihua Qu, Jim Yang Lee

[Synthesis of Durable Carbon-scaffolded \$\text{Na}_3\text{V}_2\(\text{PO}_4\)_3\$ Nanofiber Cathode for Sodium-ion Batteries](#)

10:10 to 10:30

Yuhui Chen (Department of Materials, University of Oxford, Oxford, United Kingdom), Lee Johnson, Xiangwen Gao, Stefan A. Freunberger

[Promoting solution phase discharge in Li-O₂ batteries](#)

10:30 to 10:50

Coffee Break

10:50 to 11:10

Monica Marinescu (Department of Mechanical Engineering, Imperial College London, London, United Kingdom), Teng Zhang, Sylwia Walus, Laura O'Neill, Mark Wild, Gregory Offer

[Improving performance of Li-S cells under cycling, a model-informed approach](#)

11:10 to 11:30

Frederieke Langer (Innovative Sensor and Functional Materials Research Group, University of Bremen, Bremen, Germany), Ingo Bardenhagen, Jens Gellneberg, Robert Kun

[Investigation of lithium ion transport processes in a polymer-Li₇La₃Zr₂O₁₂ hybrid electrolyte](#)

11:30 to 11:50

Irene Ruggeri (Department of Chemistry Giacomo Ciamician, Alma Mater Studiorum University of Bologna, Bologna, Italy), Catia Arbizzani, Francesca Soavi

[A Semi-Solid Catholyte for next generation Lithium/Air \(O₂\) Battery](#)

11:50 to 12:10

Yuki Orikasa (Graduate School of Human and Environmental Studies, Kyoto University, Kyoto, Japan), Yukinori Koyama, Takahiro Yoshinari, Takuya Mori, Kentaro Yamamoto, Koji Ohara, Katsutoshi Fukuda, Hajime Arai, Yoshiharu Uchimoto

[Nonequilibrium Phase Transition Mechanism between LiFePO₄ and FePO₄ during Battery Operation at Various Temperatures](#)

s06 Novel Materials and Devices for Energy Storage: Batteries for Tomorrows World

Room : Oceania Foyer

Chaired by: Eric Kelder and Tina Nestler

09:30 to 09:50

Chung-Hsien Chuang (Department of Chemical Engineering, National Taiwan University, Taipei, Taiwan),
Nae-Lih Wu

[Particle Size Effect on High Potential Performance of Li-Excess Nickel Manganese Oxide Cathode Material for Lithium-ion Batteries](#)

09:50 to 10:10

Ce Zhang (Qian Xuesen Laboratory of Space Technology, China Academy of Space Technology (CAST), Beijing, China), Fangming Cui, Yunchuan Qi, Guang Zhang, Hui Zhang, Wei Yao

[Novel Aluminum-Contained Anatase Titanium Dioxide Nanoparticles as the Anode for Aluminum Ion Batteries](#)

10:10 to 10:30

Bettina Grumm (Institute for Chemistry and Technology of Materials, Graz University of Technology, Graz, Austria), Christian Slugovc, Stefan A. Freunberger

[Hierarchically porous titanium ceramics for reversible high capacity aprotic Li-O₂ batteries](#)

10:30 to 10:50

Coffee Break

10:50 to 11:10

Philip Reinsberg (Institute of Physical Chemistry, University of Bonn, Bonn, Germany), Christoph Bondue, Helmut Baltruschat

[Mechanistic investigation of the oxygen reduction in magnesium ion-containing dimethylsulfoxide](#)

11:10 to 11:30

Jean-Pierre Pereira-Ramos (Institut de Chimie et des Matériaux Paris Est, CNRS, Thiais, France), Marianne Safrany-Renard, Diane Muller-Bouvet, Rita Baddour-Hadjean

[The \$\gamma'\$ -V₂O₅ phase: a new high voltage cathode material for sodium-ion batteries](#)

11:30 to 11:50

Ana López-Cudero (Albufera Energy Storage, Parque Centífico de Madrid, Madrid, Spain), Mikel Pino, Francisco José Pérez-Alonso, Paloma Rodríguez, Joaquín Chacón

[Carbon-Modified Anodes for Al-air Batteries with Improved Performance](#)

11:50 to 12:10

Tina Nestler (Institute of Experimental Physics, TU Bergakademie Freiberg, Freiberg, Germany), Falk Meutzner, Artem Kabanov, Matthias Zschornak, Fedotov Stanislav, Tilmann Leisegang, Vladislav A. Blatov, Dirk C. Meyer

[Are there solid electrolytes for rechargeable aluminum batteries?](#)

s07 Novel Materials and Devices for Energy Conversion and Storage: Fuel Cells, Electrolysers, Regenerative Fuel Cells and Flow Batteries

Room : King Willem Alexander

Chaired by: Matthias Arenz

09:30 to 10:10 KEYNOTE

Minoru Inaba (Department of Molecular Chemistry and Biochemistry, Doshisha University, Kyotanabe, Japan), Hideo Daimon

[Electrochemical and Chemical Activation of Pt/Pd/C Core-Shell Catalyst](#)

10:10 to 10:30

Frédéric Maillard (LEPMI, CNRS, Saint Martin d'Hères, France), Raphael Chattot, Tristan Asset, Pierre Bordet, Jakub Drnec, Laetitia Dubau

[Atomic Scale Imaging of the Growth Mechanism of Hollow PtNi/C Nanocatalysts for Oxygen Reduction Reaction](#)

10:30 to 10:50

Coffee Break

10:50 to 11:10 INVITED

Hiroyuki Uchida (Clean Energy Research Center, University of Yamanashi, Kofu, Japan), Hiroshi Yano, Satoshi Ogawa, Morio Chiwata, Masahiro Watanabe, Akihiro Iiyama

[Oxygen Reduction Reaction Activity and Durability of Carbon-Supported Pt Alloys with Stabilized Pt-Skin layers](#)

11:10 to 11:30

Ernesto Gonzalez (Department of Physical Chemistry, Instituto de Quimica de Sao Carlos-USP, Sao Carlos, Brazil), Loriz Sallum, Nyccolas Sousa, Gabriel Silva, Thairo Rocha

[Durability of a Platinum-Niobium Electrocatalyst for the Oxygen Reduction Reaction](#)

11:30 to 11:50

Matija Gatalo (Laboratory of Materials Chemistry, National Institute of Chemistry, Ljubljana, Slovenia), Primoz Jovanovic, George Polymeros, Jan-Philipp Grote, Francisco Ruiz-Zepeda, Nejc Hodnik, Goran Drazic, Marjan Bele, Karl J.J. Mayrhofer, Miran Gaberscek

[Increasing the Stability of PtCu₃/C Electrocatalyst by Surface Gold Doping and CO Annealing](#)

11:50 to 12:10

Simon A. Tschupp (Electrochemistry Laboratory, Paul Scherrer Institut, Villigen PSI, Switzerland), Waiz Karim, Yasin Ekinici, Juan Herranz, Thomas Justus Schmidt

[Model Pt catalysts with controllable particle size and interparticle distance prepared by top-down nanofabrication](#)

s07 Novel Materials and Devices for Energy Conversion and Storage: Fuel Cells, Electrolysers, Regenerative Fuel Cells and Flow Batteries

Room : Yangtze 1

Chaired by: Aleksandar Zeradjanin

09:30 to 09:50

Véronique Amstutz (Laboratoire d'Electrochimie Physique et Analytique (LEPA), Ecole Polytechnique Fédérale de Lausanne (EPFL), Sion, Switzerland), Heron Vrubel, Alberto Battistel, Christopher Raymond Dennison, Pekka Peljo, Hubert Girault

[Concept of Indirect Water Electrolysis: principle and applications](#)

09:50 to 10:10

Kensaku Nagasawa (Green Hydrogen Research Center, Yokohama National University, Yokohama, Japan), Yuki Sawaguchi, Naoto Morita, Yuji Kohno, Koichi Matsuzawa, Akihiro Kato, Yoshinori Nishiki, Shigenori Mitsushima

[Development of Bi-polar Electrolyzer for Toluene Hydrogenation](#)

10:10 to 10:30

Takuto Kushi (Energy System Research Institute, Tokyo Gas Co., Ltd., Tokyo, Japan)

[Effects of Impurity Poisoning on Degradation Phenomena in Solid Oxide Electrolysis Cells after 5000 h](#)

10:30 to 10:50

Coffee Break

10:50 to 11:10

Enrique García-Quismondo (Electrochemical Processes Unit, Madrid, Spain), Ignacio Almonacid, Veselin Miroslavov, Jesús Palma, Marc Anderson, Enrique Serrano, Angel Hernandez, Beatriz Oraá

[Operational Experience of 5 kW All-Vanadium Flow Battery in Photovoltaic Grid Applications](#)

11:10 to 11:30

Pekka Peljo (Laboratoire d'Electrochimie Physique et Analytique, Ecole Polytechnique Fédérale de Lausanne, Sion, Switzerland), Sunny Maye, Véronique Amstutz

[Heat-to-Power Conversion and Storage with Copper Redox Flow Batteries](#)

11:30 to 11:50

Aurore Lê (Institut des Sciences Chimiques de Rennes, Equipe MaCSE, University of Rennes 1, Rennes, France), Didier Floner, Thierry Roisnel, Olivier Cador, Léa Chancelier, Florence Geneste

[Iron \(III\)-triethanolamine complex electrolyte for redox flow batteries](#)

11:50 to 12:10

Javier Vázquez-Galván (Energy Storage and Harvesting / Material Science Department, Energy Catalonia Institute for Energy Research (IREC), Barcelona, Spain), Cristina Flox, Joan Ramon Morante

[Hydrogen-treated rutile-TiO₂ shell in graphite core structure as a negative electrode for high-performance vanadium flow batteries](#)

s10 Electroactive, Functionalized and Nanostructured Materials and Composites: Modern Trends in Synthesis and Applications

Room : Europe

Chaired by: Sébastien Moitzheim and Vereecken Philippe

09:30 to 09:50 INVITED

Patrik Schmuki (Materials Science, University of Erlangen-Nuremberg, Erlangen, Germany)

[A new perspective for photoelectrochemical water splitting: Black TiO₂ nanotubes](#)

09:50 to 10:10

Grzegorz Sulka (Department of Physical Chemistry & Electrochemistry, Jagiellonian University in Krakow, Krakow, Poland), Leszek Zaraska, Joanna Kapusta-Kolodziej, Agnieszka Brzózka, Magdalena Jarosz, Elzbieta Kurowska-Tabor, Ewa Wierzbicka, Anna Brudzisz, Karolina Syrek, Anna Pawlik, Karolina Gawlak

[Anodic Formation and Applications of Nanostructured Metal Oxides](#)

10:10 to 10:30

Alessandro Boni (Department of Chemistry, University of Bologna, Bologna, Italy), Giovanni Valenti, Michele Melchionna, Matteo Cargnello, Stefania Rapino, Massimo Marcaccio, Maurizio Prato, Marcella Bonchio, Paolo Fornasiero, Francesco Paolucci

[Co-axial Heterostructures Integrating Pd@TiO₂ with Carbon Nanotubes for the Efficient Hydrogen Evolution Reaction at Neutral-pH](#)

10:30 to 10:50

Coffee Break

10:50 to 11:10

Magdalena Skompska (Faculty of Chemistry, University of Warsaw, Warsaw, Poland), Maciej Kwiatkowski, Igor Bezverkhy

[Photocatalytic and Photoelectrochemical Properties of Nanostructured ZnO/TiO₂ Core-Shell Composites](#)

11:10 to 11:30

Balázs Endrődi (Department of Physical Chemistry and Materials Science, University of Szeged, Szeged, Hungary), Péter S. Tóth, Robert Dryfe, Csaba Janáky

[Exploring the pH-Potential Cosmos: Direct Electrodeposition of Nanocrystalline TiO₂ Films on Different Carbon Electrodes](#)

11:30 to 11:50

Neus Vila (Laboratoire Chimie Physique Microbiologie pour Environnement, Université de Lorraine-CNRS, UMR 7564, Villers-les Nancy, France), Alain Walcarius

[Functionalization of Vertically-aligned Mesoporous Silica Films](#)

11:50 to 12:10

Minwei Zhang (Chemistry, Technical University of Denmark, Copenhagen, Denmark), Arnab Halder, Chengyi Hou, Qijin Chi

[Prussian Blue Functionalized Graphene Composites for Electrochemical Sensing and Energy Applications](#)

s10 Electroactive, Functionalized and Nanostructured Materials and Composites: Modern Trends in Synthesis and Applications

Room : Kilimanjaro

Chaired by: Corina Andronescu and Paolucci Francesco

09:30 to 10:10 KEYNOTE

Olle Inganäs (Biomolecular and Organic Electronics, IFM, Linköpings Universitet, Linköping, Sweden)

[Biopolymers and electronic polymers combined for energy storage](#)

10:10 to 10:30 INVITED

Stanko Brankovic (ECE, University of Houston, Houston, USA), Wu Dongjun, Kamyar Ahmadi

[Au Surface Chemo-Resistivity Improvement Using Metal Deposition via SLRR](#)

10:30 to 10:50

Coffee Break

10:50 to 11:10

Salvatore Piazza (Dipartimento di ingegneria Chimica Gestionale Informatica Me, Università di Palermo, Palermo, Italy), Bernardo Patella, Rosalinda Inguanta, Carmelo Sunseri

[Pd-NWs ordered arrays for electrochemical sensing of H₂O₂](#)

11:10 to 11:30

Alexander Vaskevich (Materials and Interfaces, Weizmann Institute of Science, Rehovot, Israel), Mariano D. Susman, Yishai Feldman, Tatyana B. Bendikov, Israel Rubinstein

[Copper nanoparticle oxidation: A plasmonic perspective](#)

11:30 to 11:50

Masa-aki Haga (Department of Applied Chemistry, Chuo University, Bunkyo-ku, Japan), Hiroaki Sato, Hiroaki Ozawa, Katsuaki Kanaizuka, Masato Kurihara, Taknari Togashi

[Electrochemical Interfacing between Prussian Blue Nanocrystals and ITO Electrode by Redox-active Molecular Multilayer](#)

11:50 to 12:10

Giovanni Valenti (Chemistry G. Ciamician, University of Bologna, Bologna, Italy), Martina Zangheri, Mara Mirasoli, Alain Penicaud, Aldo Roda, Francesco Paolucci

[Transparent carbon nanotube network for efficient electrochemiluminescence device](#)

s13 Corrosion: The Electrochemistry of Corrosion and Approaches to Corrosion Protection

Room : Everest

Chaired by: Mary Ryan

09:30 to 09:50

Sigrid Benfer (Corrosion, DECHEMA-Forschungsinstitut, Frankfurt am Main, Germany), Wolfram Fürbeth, Benjamin Straß, Marco Thomä, Guntram Wagner

[Investigations on the corrosion properties of ultrasound supported friction stir welded hybrid joints](#)

09:50 to 10:10

Christian Dieleman (Novel Aerospace Materials, Faculty of Aerospace Engineering, Delft University of Technology, Delft, Netherlands), Yen Truong, Ilias Kyrtziz, Anthony Hughes, James Mardel, Santiago Garcia

[Active anti-corrosion protection of AA2024-T3 by electrospun nanofibers](#)

10:10 to 10:30

Kang Shi (Department of Chemistry, Xiamen University, China), Zhi Gang Dong, Ya Hui Wang, Li Wei Ou, Dan Wu, Xuan Zheng

[Study on Photo-Electrochemical Etching of GaN Wafer in Deep Eutectic Solvents](#)

10:30 to 10:50

Coffee Break

10:50 to 11:10

Wan-Zhen Hsieh (Chemical Engineering & Materials Science, Yuan Ze University, Taoyuan City, Taiwan), Pei-Tzu Lee, Hsiao-Keng Wang, Cheng-En Ho

[Thermal Reliability of Au/Pd/Cu and Au/Pd\(P\)/Cu Multilayer during Isothermal Annealing](#)

11:10 to 11:30

Thomas Hersbach (Leiden Institute of Chemistry, Leiden University, Leiden, Netherlands), Alexei Yanson, Marc Koper

[Of polygons in platinum: highly anisotropic etching at the onset of cathodic corrosion](#)

11:30 to 11:50

Song-Zhu Kure-Chu (Department of Chemistry and Bioengineering, Iwate University, Morioka, Japan), Toru Ogasawa, Rie Nakagawa, Michimasa Uchidate, Rongbin Ye, Hitoshi Yashiro, Kuniaki Sasaki

[Tailored Fabrication and Fretting Corrosion Resistance of Nano-laminated Sn/Ag₃Sn \(/Ag\) Films Electrodeposited on Cu Alloy Plates for Electrical Connectors](#)

11:50 to 12:10

Joerg Posdorfer (Electrochemistry, MacDermid Enthone Industrial Solutions, Langenfeld, Germany), Ronald Gensicke, Edward Kudrak, Mahima Raddiar, Kamaraj Kandhasamy, Mahima Subhramannya, Naveen Taj, Haritosh Mishra

[Effect of Nickel Content in Corrosion Behavior of Electrodeposited Zinc-Nickel Coatings](#)

s18 Electrochemistry, Photoelectrochemistry and Bioelectrochemistry of Artificial Photosynthesis: Recent Advances in CO₂ Conversion to Products

Room : Yangtze 2

Chaired by: Monica Barroso and Wilson Smith

09:30 to 10:10 KEYNOTE

Teresa Andreu (Advanced Materials for Energy Area, Catalonia Institute for Energy Research, Sant Adrià del Besòs, Spain), Erdem Irtem, Andrés Parra, Cristian Fàbrega, Sebastián Murcia-López, Maria Dolores Hernández-Alonso, Germán Penelas, Joan Ramon Morante

[Solar photoelectrochemical process for CO₂ valorisation to fuels](#)

10:10 to 10:30

Carles Ros (Advanced Materials Area, IREC (Catalonian Institute for Energy Research), Sant Adrià del Besòs, Spain), Sergio Girado, Zhishan Luo, Edgardo Saucedo, Teresa Andreu, Andreu Cabot, Joan Ramon Morante

[Towards sustainable solar fuels using earth abundant materials: kesterite based photocathodes](#)

10:30 to 10:50

Coffee Break

10:50 to 11:10

Jean-Daniel Compain (Institut de Chimie, Université de Strasbourg, Strasbourg, France), Matthew Stanbury, Sylvie Chardon-Noblat

[Electro- and photo-driven catalytic conversion of CO₂ using molecular manganese carbonyl based catalysts](#)

11:10 to 11:30

Min-Kyu Son (Institute of Chemical Sciences and Engineering, Ecole Polytechnique Federale de Lausanne, Lausanne, Switzerland), Ludmilla Steier, Matthew T. Mayer, Jingshan Luo, Marcel Schreier, Michael Graetzel

[Transparent Cuprous Oxide Photocathode on the Copper-doped Nickel Oxide Underlayer for Water Splitting](#)

11:30 to 11:50

Youngkook Kwon (Joint Center for Artificial Photosynthesis, Lawrence Berkeley National Laboratory, Berkeley, USA), Alexis T. Bell

[Electrocatalytic CO₂ Reduction to High Ethylene Selectivity](#)

11:50 to 12:10

Fengwang Li (School of Chemistry, Monash University, Melbourne, Australia), Mianqi Xue, Ying Zhang, Lu Chen, Douglas MacFarlane, Jie Zhang

[Graphene Supported Two-Dimensional Metal Sulfide Materials for Electrocatalytic Reduction of CO₂ in Aqueous Medium](#)

s20 General Session

Room : Amazon

Chaired by: Guy Denuault and Barbara Palys

09:30 to 09:50

Ramona Gutkowski (Analytical Chemistry, Center of Electrochemical Science, Ruhr-Universität Bochum, Bochum, Germany), Chinmay Khare, Kirill Sliozberg, Felipe Conzuelo, Alfred Ludwig, Wolfgang Schuhmann
[Combinatorial sputter deposition of nanostructured Bi-V-O-Mo-M' material libraries for solar energy conversion: High-throughput characterization with an OSDC and SPECM](#)

09:50 to 10:10

Peter Knittel (Institute of Analytical and Bioanalytical Chemistry, Ulm University, Ulm, Germany), Christine Kranz

[Combining Scanning Electrochemical Microscopy with Peak Force Tapping Atomic Force Microscopy](#)

10:10 to 10:30

Nejc Hodnik (Laboratory of Catalysis and Chemical Reaction Engineering, National Institute of Chemistry, Ljubljana, Slovenia), Claudio Baldizzone, Karl J.J. Mayrhofer

[Recycling of platinum at mild conditions: in low concentrated acid and at room temperature](#)

10:30 to 10:50

Coffee Break

10:50 to 11:10

Kristel Jukk (Institute of Chemistry, University of Tartu, Tartu, Estonia), Nadezda Kongi, Protima Rauwel, Leonard Matisen, Kaido Tammeveski

[Platinum Nanoparticles Supported on Nitrogen-Doped Graphene Nanosheets as Electrocatalysts for Oxygen Reduction Reaction](#)

11:10 to 11:30

Elo Kibena-Pöldsepp (Institute of Chemistry, University of Tartu, Tartu, Estonia), Jaana Lilloja, Mairo Merisalu, Protima Rauwel, Leonard Matisen, Ahti Niilisk, Eduardo S.F. Cardoso, Gilberto Maia, Väino Sammelseg, Kaido Tammeveski

[A Comparative Study of Graphene-Based Electrodes Towards ORR](#)

11:30 to 11:50

Saiful Arifin Bin Shafiee (Chemistry, University of Southampton, Southampton, United Kingdom), Guy Denuault, Andrew Hector

[Fabrication, Characterisation and Applications of Bulk Ti-N Microband Electrodes](#)

11:50 to 12:10 **ISE PRIZE FOR ENVIRONMENTAL ELECTROCHEMISTRY**

Kangwoo Cho (Center for Water Resource Cycle Research, Korea Institute of Science and Technology, Seoul, Korea), Michael R. Hoffmann

[Wastewater Electrolysis Cell: Application of Environmental Electrochemistry for Water-Energy Nexus](#)

Poster presentation program



Symposium 1 New Horizons in Analytical Electrochemistry

Advanced techniques

s01-001

Serena Arnaboldi (Dipartimento di Chimica, Università degli Studi di Milano, Milano, Italy), Patrizia Mussini, Armando Gennaro, Abdirisak Ahmed Isse, Voichita Mihali, Simona Rizzo, Francesco Sannicolò

[Achieving chiral electroanalysis on achiral electrodes in innovative “inherently chiral” ionic liquid media](#)

s01-002

Cameron Bentley (School of Chemistry, Monash University, Clayton, Australia), Jiezhen Li, Alan M. Bond, Jie Zhang

[Mass-Transport and Heterogeneous Electron-Transfer Kinetics Associated with the Ferrocene/Ferrocenium Process in Non-Haloaluminate Ionic Liquids](#)

s01-003

Christian Heubner (Institute of Materials Science (IfWW), TU Dresden, Dresden, Germany), Christoph Lämmel, Michael Schneider, Alexander Michaelis

[Advantages of Higher Harmonics Analysis for the Investigation of Insertion Electrodes](#)

s01-004

Juyeon Kang (Department of Chemistry, Pusan National University, Busan, Korea), Al-Monsur Jiaul Haque, Haesik Yang

[Amplified Enzymatic Ag Deposition by Redox Cycling and its Application in the Ultrasensitive Detection of Creatine Kinase-MB](#)

s01-005

Noah Kebede (Department of Chemistry and Physics, La Trobe University, Melbourne, Australia), Paul Francis, Gregory Barbante, Conor Hogan

[Electrogenerated Chemiluminescence of Tris\(2,2' bipyridine\)ruthenium\(II\) Using Common Biological Buffers As Co-reactant, pH Buffer and Supporting Electrolyte](#)

s01-006

Akira Kotani (School of Pharmacy, Tokyo University of Pharmacy and Life Sciences, Hachioji, Tokyo, Japan), Kanae Kitamura, Fumiyo Kusu, Kazuhiro Yamamoto, Hideki Hakamata

[Development of a Sensor for Determining Amino Acidity in Japanese Sake by Means of Voltammetric Measurement of Surplus Acid](#)

s01-007

Hye Jin Lee (Chemistry, Kyungpook National University, Daegu, Korea), Hye Youn Han, Farhana Sharmin Diba

[Enzymatically Amplified Electrochemical Nanobiosensing Platforms for Biological Applications](#)

s01-008

Jiezhen Li (School of Chemistry, Monash University, Melbourne, Australia), Cameron Bentley, Alan M. Bond, Jie Zhang

[Determination of Electrode Kinetics Approaching the Reversible Limit Using a Double Frequency Method in Fourier Transformed Large-Amplitude Alternating Current Voltammetry](#)

s01-009

Ponnusamy Nandhakumar (Department of Chemistry, Pusan National University, Busan, Korea), Soodong Noh, Haesik Yang

[Facile Electrochemical Detection of Escherichia Coli Using Redox Cycling of the Product Generated by the Intracellular \$\beta\$ -D-Galactosidase](#)

s01-010

Seonhwa Park (Department of Chemistry, Pusan National University, Busan, Korea), Haesik Yang

[Facile Electrochemical Detection of Botulinum Neurotoxin Type E Using a Two-Step Proteolytic Cleavage](#)

s01-011

Jeongwook Seo (Dept. of Chemistry, Pusan National University, Busan, Korea), Seonhwa Park, Haesik Yang

[Electrochemical Detection of Vaccinia Virus in a Solution Containing L-Ascorbic Acid](#)

s01-012

Ulriika Vanamo (Lab. of Analytical Chemistry, Lab. of Materials Chemistry, Åbo Akademi University, University of Turku, Turku, Finland), Johan Bobacka

[Towards Calibration-Free Measurements with All-Solid-State Potentiometric Sensors by Reproducible Resetting of the Standard Potential \(\$E^\circ\$ \)](#)

Advances in instrumentation

s01-013

Olivier Buriez (Department of Chemistry, Ecole Normale Supérieure, Paris, France), Ana Isabel Perez Jimenez, Lylian Challier, Margherita Di Pisa, Manon Guille-Collignon, Frédéric Lemaître, Solange Lavielle, Christelle Mansuy, Christian Amatore, Eric Labbé

[A Three-Electrode Analytical Hand-Held Device](#)

s01-014

Frédérique Deiss (Chemistry and Chemical Biology, IUPUI, Indianapolis, USA), Armelle Metangmo

[Electrochemical Detection of Bacteria using Portable Paper-based Culture Devices](#)

s01-015

Sahana Sarkar (Nano Ionics, University of Twente, Enschede, Netherlands)

[Unconventional Potentiometry of Reversible Redox species at Ultra-low Concentrations in Nanogap Transducers](#)

Coupled-electrochemical techniques

s01-016

Maria-Antonietta Baldo (Department of Molecular Sciences and Nanosystems, Università Ca' Foscari Venezia, Venice, Italy), Angela Maria Stortini, Ligia Maria Moretto, Paolo Ugo

[A Combined Electrochemical and Spectroscopic Approach for Trace Lead Analysis in Olive Oils using RTIL as Electrolyte](#)

s01-017

Anna Muhs (Analytical Chemistry - Center for Electrochemical Sciences, Ruhr-Universität Bochum, Bochum, Germany), Jan Clausmeyer, Miriam Marquitan, Yanjun Zhang, Yuri Korchev, Wolfgang Schuhmann

[Nanosized Field-Effect Transistor Sensors for pH-sensitive Imaging Using Scanning Electrochemical Microscopy/Scanning Ion Conductance Microscopy](#)

New analytes, improved data analysis methodologies

s01-018

Yun Bao (Graduate School of Engineering, Yokohama National University, Yokohama, Japan), Teko Napporn, Kensaku Nagasawa, Yuji Kohno, Koichi Matsuzawa

[Method of Evaluating of Toluene Electro-Hydrogenation Reaction: Charge and Mass Transfer](#)

s01-019

Ariadna Brotons Cuevas (Institute of Electrochemistry, Alicante University, Alicante, Spain), Ignacio Sanjuán, Christopher W Foster, Craig E. Banks, Francisco Jose Vidal-Iglesias, Jose Solla-Gullón, Jesus Iniesta

[Easy and Cost Effective Enzymatically Digested Oligonucleotides for the Electrochemical Quantification of Guanosine and Adenosine Monophosphate Using Screen Printed Graphite Electrodes](#)

s01-020

Ariadna Brotons Cuevas (Institute of Electrochemistry, Alicante University, Alicante, Spain), Juan Miguel Feliu Martinez, Vicente Montiel, Jesus Iniesta, Francisco Jose Vidal-Iglesias, Jose Solla-Gullón

[Specific Adsorption-Desorption of Nucleobases, Nucleosides and Nucleotides on Polycrystalline and Monocrystalline Gold Surfaces](#)

s01-021

Eric Gil (Pharmacy School, Federal University of Goiás, Goiânia, Brazil), Valéria Oliveira, Gabriela Nóbrega, Kamila Japiassu, Ruteira Moraes, Paulo Cesar Ghedini

[Electroanalytical Evaluation of the Natural Polyphenols, Curcumin and Morin: Their Bio Converted Antioxidant Products](#)

s01-022

Dafne Guzmán-Hernández (Analytic Chemistry, Universidad Autónoma del Estado de Hidalgo, Mexico, Mexico), Maria Teresa Ramirez-Silva, Marlene Cid-Ceron, Manuel Palomar-Pardavé, Mario Romero-Romo, Silvia Corona-Avendaño

[Simultaneous electrochemical quantification of diclofenac and acetaminophen in the presence of CTAB micelles.](#)

s01-023

Zhi Jinfang (Technical Institute of Physics and Chemistry, Chinese Academy of Science, Beijing, China), Fang Deyu, Gao Guanyue, Gao Guanyue, Yu Yuan, Shen Jie

[Adaptive Use of Personal Glucose Meter \(PGM\) for Acute Biototoxicity Assessment based on the Glucose Consumption of Microbes](#)

s01-024

Isman Khazi (Faculty of Medical and Mechanical Engineering, Hochschule Furtwangen University, Furtwangen, Germany), Ulrich Mescheder

[Influence of Anode to Cathode Distance on the Alloy Composition in Anomalously Electrodeposited Nickel-Cobalt Alloys](#)

s01-025

Bruna C. Lourencao (Department of Chemistry, UFSCar, São Carlos, Brazil), Tiago Silva, Ricardo F. Brocenschi, Orlando Fatibello-Filho, Romeu C. Rocha-Filho

[Boron-Doped Diamond Electrode Explored for the Electrochemical Study and Simultaneous Electroanalytical Detection of Naphthol Isomers](#)

s01-026

Udo Rohr (SO-AC9, Merck KGaA, Darmstadt, Germany)

[Conductivity Measurement in the pS/cm Range](#)

s01-027

Nick Slegers (Department of Chemistry (AXES Research Group), University of Antwerp, Antwerp, Belgium), Fabio Bottari, Karolien De Wael

[Development of an electrochemical screening strategy for the detection of \$\beta\$ -lactam antibiotics in a variety of streams](#)

s01-028

Jing-Juan Xu (Chemistry, Nanjing University, Nanjing, China)

[Dual-wavelength Electrochemiluminescence Ratiometry for microRNA Detection](#)

s01-029

Haesik Yang (Department of Chemistry, Pusan National University, Busan, Korea)

[Washing-Free Electrochemical Immunosensor Using Redox Cycling](#)

s01-030

Wei-Wei Zhao (Chemistry, Nanjing University, Nanjing, China)

[Simultaneous Photoelectrochemical Immunoassay of Dual Cardiac Markers Using Specific Enzyme Tags: A Proof of Principle for Multiplexed Bioanalysis](#)

s01-031

Guzel Ziyatdinova (Analytical Chemistry Department, Kazan Federal University, Kazan, Russia), Endzhe Ziganshina, Phuc Nguyen Cong, Herman Budnikov

[Coulometric Titrants as Reagents for the Evaluation of Antioxidant Properties of Spices Micellar Extracts](#)

s01-032

Maria Angelica del Valle (Facultad de Química, Pontificia Universidad Católica de Chile, Santiago, Chile), Valentina Muñoz, Francisco Martínez, Mauricio Isaacs, Francisco Armijo

[Electrochemical oxidation mechanism of ambroxol and its voltammetric determination on FTO electrode](#)

Novel electrochemical interfaces

s01-033

Martha Collins (Lab de Chimie Physique et Microbiologie pour l'Environnement, Université de Lorraine, Nancy, France), Marc Hebrant, Gregoire Herzog

[Analyte pre-concentration by self-assembly of silica nanoparticles at the liquid-liquid interface](#)

s01-034

Karolien De Wael (Department of Chemistry, University of Antwerp, Antwerp, Belgium)

[Biomolecule-free, Selective Photoelectrochemical Detection Using Immobilized Fluoroalkylated Zinc Phthalocyanine Photosensitizer](#)

s01-035

Xiang He (Division of Lake Environment and Engineering, Nanjing Institute of Geography and Limnology, CAS, Nanjing, China)

[Three-Dimensional Porous Gold Microarray for Simultaneous Assay of Various Cancer Biomarkers](#)

s01-036

Baohong Liu (Department of Chemistry, Fudan University, Shanghai, China), Yun Liu, Huiying Xu, Lina Zhu, Yujie Liu, Jingjing Xiao, Hui Chen

[Sensitive Quantification of Biomolecules and Tumor Cells based on Nanomaterial Functionalized Electrochemical Biosensors](#)

s01-037

Angela Molina (Physical Chemistry, University of Murcia, Murcia, Spain), Eduardo Laborda, José Manuel Olmos

[Voltammetry of the Transfer of Complexed and Dissociated Ionic Species at Soft Interfaces. Study of the Influence of the Charge, Chemical Reactivity and Mass Transport of the Species](#)

s01-038

Francis Ntumba Muya (Chemistry, University of the Western Cape, Cape Town, South Africa), Priscilla Baker, Emmanuel Iwuoha, Nicole Jaffrezic Renault, Abdelhamid Errachid, Abdoullatif Barakat, Selim Boudjoui

[Novel highly sensitive enzymatic gas bio-sensor for detection of formaldehyde](#)

s01-039

Rejane Maria Pereira Da Silva (Centro de Ciências Naturais e Humanas, Universidade Federal do ABC, Santo André, Brazil), Lucas Carvalho Lima, Ivanize Gaubeur, Hugo Barbosa Suffredini

[Dispersive Liquid-Liquid Microextraction Combined with Oil/Water Interface Electrochemistry for the Determination of Ferrocene](#)

Novel electrodes and electrode materials

s01-040

Alejandra Abellán (Instituto de Materiales, Universidad de Alicante, Alicante, Spain), Itthipon Jeerapan, Amay Bandodkar, Lorena Vidal, Antonio Canals, Joseph Wang, Emilia Morallón

[Design of a stretchable electrochemical device for glucose detection](#)

s01-041

Alejandra Abellán (Instituto Universitario de Materiales, Universidad de Alicante, Alicante, Spain), Carolina Gonzalez, Lorena Vidal, Antonio Canals, Emilia Morallón

[Uric acid quantification in presence of ascorbic acid using arrays of microelectrodes modified with carbon nanofibers functionalized with 4-ABA.](#)

s01-042

Termeh Darvishzad (Biotechnology and Physical Chemistry, Cracow University of Technology, Krakow, Poland), Stefan Kurek

[Guanine Sensors Based on Swollen Conducting Polymer Capable of H-Bonding](#)

s01-043

Camilo González-Vargas (Universidad de Santiago de Chile, Santiago, Chile), Ricardo Salazar

[Electrodetermination of hydrochlorothiazide by Glassy Carbon electrodes modified by electropolymerization with L- and D- glutamic acids.](#)

s01-045

Stefan Klink (Analytical Chemistry - Center for Electrochemical Sciences, Ruhr-University Bochum, Bochum, Germany), Yu Ishige, Wolfgang Schuhmann

[Ion-Sensing Cheap as Chips: Intercalation Compounds as Solid-Contact Reference Electrodes for Ion-Selective Electrodes](#)

s01-046

Osamu Niwa (Advanced Science Research Laboratory, Saitama Institute of Technology, Fukaya, Japan), Shunsuke Shiba, Daiki Kato, Tomoyuki Kamata, Dai Kato

[Metal Nanoparticles Embedded Carbon Film Electrodes for Environmental and Biochemical Analyses](#)

s01-047

Keagan Pokpas (SensorLab, Department of Chemistry, University of the Western Cape, Bellville, South Africa), Nazeem Jahed, Priscilla Baker, Emmanuel Iwuoha

[Detection of Nickel \(II\) at a Metal-Free Graphene-Chelate Probe In the Presence of Cobalt and Zinc by Adsorptive Stripping Voltammetry](#)

s01-048

Eduardo Ponzio (Physical Chemistry, Federal Fluminense University, Niterói, Brazil), Ana Silva, Matheus Correa, Grasielli Oliveira, Pedro Florez-Rodriguez, Felipe Semaan

[Graphite/silicone composites as flexible electrode materials](#)

s01-049

Libuse Trnkova (Department of Chemistry, Faculty of Science, Masaryk University, Brno, Czech Republic), Jan Hrbac, Rudolf Navratil, Adela Kotzianova, Tomas Opletal, Vladimir Halouzka

[Polymer Pencil Graphite as Electrode Material for Sensing](#)

s01-050

Eleonora-Mihaela Ungureanu (Inorganic Chemistry, Physical Chemistry and Electrochemistry, University Politehnica of Bucharest, Bucharest, Romania), George-Octavian Buica, Elena Diacu, Liviu Birzan, Georgiana-Luiza Arnold

[Azulene-Thiourea-Like Chemically Modified Electrodes for Heavy Metal Ions Detection](#)

s01-051

Guzel Ziyatdinova (Analytical Chemistry Department, Kazan Federal University, Kazan, Russia), Ekaterina Kozlova, Herman Budnikov

[New Electrodes Based on Electropolymerized Phenolic Antioxidants for the Evaluation of Beverages Antioxidant Properties](#)

s01-052

Termeh Darvishzad (Biotechnology and Physical Chemistry, Cracow University of Technology, Krakow, Poland), Stefan Kurek

[Voltammetric Studies of H-Bond Interactions of Guanine with Pyridinecarboxylic Acids](#)

s01-053

Eric Gil (Pharmacy School, Federal University of Goias, Goiânia, Brazil), Isaac Macedo, Luane Garcia, Karla Carneiro de Siqueira Leite, Paulo Cesar Ghedini, Isabela Lopes, Boniek Gontijo Vaz, Jeronimo Neto

[Electroanalytical Tools for Evaluation of Antioxidant Profile of Dried Extracts of Red Fruits](#)

Symposium 2 Nanostructured Materials in Electroanalytical Chemistry

Electrocatalysis in electroanalysis

s02-001

Soledad Bollo (Pharmacological Sciences, University of Chile, Santiago, Chile), Constanza Venegas, Gustavo A. Rivas, Marco Eguilaz

[Bienzymatic glucose biosensor based on the use of multi-walled carbon nanotubes non-covalently functionalized with cytochrome c](#)

s02-002

Alexander Botz (Analytical Chemistry - Center for Electrochemical Sciences, Ruhr-Universität Bochum, Bochum, Germany), Jan Clausmeyer, Denis Ohl, Wolfgang Schuhmann

[Kinetic Investigation of the Oxygen Reduction Reaction at Silver Nanoparticles in Alkaline Media Using Scanning Electrochemical Microscopy](#)

s02-003

Saurav K. Guin (Electrochemistry Section, Fuel Chemistry Division, Bhabha Atomic Research Centre, Department of Atomic Energy, Mumbai, India), Arvind S. Ambolikar, J. V. Kamat

[Interfacial Catalytic Electron Transfer of Pu\(IV\)/Pu\(III\) at Platinum-sub-microparticles \(PtsMPs\)](#)

s02-004

Lucas Patricio Hernandez Saravia (Institute of Chemistry- Fundamental, University of Sao Paulo, Sao Paulo, Brazil), Anandhakumar Sukeri, Josué Martins Gonçalves, Juan Aguirre, Koiti Araki, Henrique Eisi Toma, Mauro Bertotti

[Cobalt-Ruthenium Based Porphyrin Complex/Graphene Oxide Composite Modified Electrode for Electrocatalytic Reduction of Oxygen](#)

s02-005

Meixian Li (College of Chemistry and Molecular Engineering, Peking University, Beijing, China), Tanyuan Wang

[Electrocatalysis and Electrochemical Sensing Based on Nanostructured MoS₂](#)

s02-006

Xiuting Li (Department of Chemistry, University of Oxford, Oxford, United Kingdom), Christopher Batchelor-McAuley, Samuel A. I. Whitby, Kristina Tschulik, Lidong Shao, Richard G. Compton

[Single Carbon Nanotube Voltammetry: Contact Modulation of the Mediated Current](#)

s02-007

Enrico Marsili (Singapore Centre for Environmental Life Sciences Engineering, Nanyang Technological University, Singapore, Singapore), Kannan Palanisamy, Abeed Fatima Binti Mohammed Batcha, Carlo Santoro, Thomas Seviour, Jamie Hinks, Federico M. Lauro

[Carbon nanotube supported Escherichia coli as a bioanode for detection of volatile organic compounds](#)

s02-008

Ayesha Mujtaba (Chemistry, Quaid-i-Azam University, Islamabad, Pakistan), Naveed Kausar Janjua

[Superior catalytic activity for methanol and glucose electro-oxidation owing to synergistic contribution of copper and iron oxides](#)

s02-009

Weronika Ozimek (Department of Chemistry, University of Warsaw, Warsaw, Poland), Iwona A. Rutkowska, Pawel J. Kulesza

[Functionalized Noble Metal Nanoparticles as Catalysts for Arsenate\(III\) Oxidation and Reduction Processes](#)

s02-010

Oliver Rodriguez-Martinez (Chemistry, University of Southampton, Southampton, United Kingdom), Guy Denuault

[Study of the Oxygen Reduction Reaction by Sampled Current Voltammetry on Single and Multiple Pt Nanoparticles](#)

s02-011

Yuanyang Rong (Chemistry, University of Bath, Bath, United Kingdom), Qilei Song, Daping He, Richard Malpass-Evans, Mariolino Carta, Neil B. McKeown, Tomos J. Clarke, Stuart H. Taylor, Frank Marken

[Novel Catalytic Microporous Heterocarbon Nanofilm Electrodes Derived from Intrinsically Porous Polymer Hosts](#)

s02-012

Bozdech Sebastien (Electrochemistry and Energy Conversion, ICPEES, Strasbourg, France)

[Influence of the size and of the supporting electrolyte on the emergence of potential fluctuations at a Pt microelectrode during CO oxidation.](#)

s02-013

Toshimasa Wadayama (Graduate School of Environmental Studies, Tohoku University, Sendai, Japan), Ryutaro Kawamura, Masato Asano, Ren Sasakawa, Naoto Todoroki

[ORR Activity and Durability for Pt\(111\) Epitaxial Layers Prepared on Pt_xNi_{1-x} \(111\) Single Crystal Alloy Substrates](#)

s02-014

Li Wang (College of Chemistry and Chemical Engineering, Jiangxi Normal University, Nanchang, China), Coucong Gong, Yonghai Song

[MP-11@PCN-333 \(Al\) Modified Macroporous Carbon Electrode for the Detection of Hydrogen Peroxide](#)

s02-015

Thidarat Wongsawa (Department of Chemistry and Bioengineering, Iwate University, Iwate, Japan), Tatsuya Takeguchi, Napan Narischat, Koichi Ui

[Linear Sweep Voltammetry of Bimetallic PtRu Alloy Nanoparticles in Various Types of Carbon Supports for CO Oxidation Activity](#)

s02-016

Ding Yuan (Department of Chemistry, Xiamen University, Xiamen, China)

[SECM Investigation on the Facet-Dependent Photocatalytic Performance of \$\alpha\$ -Fe₂O₃ Nanocrystals](#)

Electrodes modified with nano-objects

s02-017

Azam Anaraki Firooz (Chemistry, Shahid Rajaei Teacher Training University, Tehran, Iran), Bahram Hosseini Nia

[A Voltammetric Sensor Based On SnO₂ and Fe doped SnO₂ Nanoparticles -Modified Carbon-Paste Electrode For Determination of Levodopa](#)

s02-018

Azam Anaraki Firooz (Chemistry, Shahid Rajaei Teacher Training University, Tehran, Iran)

[Synthesis of porous ZnO nanostructures for glucose direct electrochemical biosensor](#)

s02-019

Patricia Batista Deroco (Department of Chemistry, Federal University of São Carlos, São Carlos, Brazil), Iasmim Gonzaga de Melo, Katlin Eguiluz, Giancarlo Salazar-Banda, Orlando Fatibello-Filho

[Pd@Au and Au@Pd Core-Shell Nanoparticles Supported on Carbon lack for the Development of Hydrazine Electrochemical Sensor](#)

s02-020

Barbara Bohlen (Department of Chemistry, Federal University of São Carlos, São Carlos, Brazil), Fernando Vicentini, Orlando Fatibello-Filho

[A Glassy Carbon Electrode Modified with Carbon Black and Gold Nanoparticles for the Simultaneous Determination of Paracetamol and Tryptophan](#)

s02-021

Gulcin Bolat (Department of Chemistry, Hacettepe University, Ankara, Turkey)

[Voltammetric Determination of Methyl Parathion Based on Single Walled Carbon Nanotubes-Polyaniline Nanocomposite Film Modified Electrode](#)

s02-022

Agustin E. Bolzan (Electrochemistry, Inst. Investigaciones Fisicoquímicas Teóricas y Aplicadas, La Plata, Argentina), Eduar Gutiérrez Pineda, María José Rodríguez Presa, Claudio A. Gervasi

[Electrodeposition of gold nanostructures on polypyrrole electrodes for electrochemical sensing](#)

s02-023

Cecilia Cristea (Analytical Chemistry, Iuliu Hatieganu University of Medicine and Pharmacy, Cluj-Napoca, Romania), Andrea Cernat, Mihaela Tertis, Nicoleta Papara, Robert Sandulescu

[Composite Nanoplatfoms for Dopamine Detection](#)

s02-024

Mathies Evers (Faculty of Chemistry and Biochemistry, Ruhr-University Bochum, Bochum, Germany), Kristina Tschulik

[Single Nanoparticle Analysis](#)

s02-025

Zdenek Farka (CEITEC MU, Masaryk University, Brno, Czech Republic), Tomas Jurik, Pavel Podesva, David Kovar, Frantisek Foret, Petr Skladal

[Gelatin-templated Nanostructured Gold for Electrochemical Detection of Glucose in Serum](#)

s02-026

Orlando Fatibello-Filho (Department of Chemistry, Federal University of São Carlos, São Carlos, Brazil), Ademar Wong, Tiago Silva, Fernando Vicentini

[A novel electrochemical sensor based on graphene oxide and an ionic liquid for highly sensitive detection of the antibiotic ofloxacin](#)

s02-027

Orlando Fatibello-Filho (Department of Chemistry, Federal University of São Carlos, São Carlos, Brazil), Ademar Wong, Claudia Razzino, Tiago Silva

[Square-wave voltammetric determination of clindamycin using a graphene oxide and gold nanoparticles based electrochemical sensor](#)

s02-028

Masoumeh Ghalkhani (Department of Chemistry, Faculty of Science, Shahid Rajaei Teacher Training University, Tehran, Iran)

[Electrodeposition of Cobalt Tetraaminophthalocyanine Thin Film on The Reduced Graphene Oxide Modified Electrode: Application For the Electro-Oxidation of Guanine](#)

s02-029

Masoumeh Ghalkhani (Department of Chemistry, Faculty of Science, Shahid Rajaei Teacher Training University, Tehran, Iran)

[Application of Bismuth Nanoparticles Decorated Reduced Graphene Oxide Nanocomposite for Highly Sensitive Xanax Determination](#)

s02-030

Ramona Gutkowski (Analytical Chemistry - Center of Electrochemical Science, Ruhr-Universität Bochum, Bochum, Germany), Wolfgang Schuhmann

[Modification of FTO surfaces with Pt-nanoparticles for enhanced photoelectrochemical response of electrodeposited n-type semiconductor materials](#)

s02-031

Elvira Gómez (Química Física, University of Barcelona, Barcelona, Spain), Alvaro Colina, David Ibañez, Aranzazu Heras, Elisa Vallés

[Supported Electrodeposited Ag Nanoparticles on SWCNTs](#)

s02-033

Gregoire Herzog (LCPME, CNRS-Universite de Lorraine, Nancy, France), Tauqir Nasir, Lin Zhang, Neus Vila, Alain Walcarius

[Vertically Oriented Mesoporous Silica on Glassy Carbon Electrodes for Electroanalysis](#)

s02-034

Jan Hrbac (Institute of Chemistry, Masaryk University, Brno, Czech Republic), Vladimir Halouzka, Barbora Halouzlkova, Athanassios G. Kontos, Eirini Siradini, Polycarpos Falaras

[Nanostructured copper-coated carbon microelectrodes for SERS sensing prepared by electrochemical/electrophoretic technique](#)

s02-035

David Ibañez (Department of Chemistry, University of Burgos, Burgos, Spain), Aranzazu Heras, Alvaro Colina

[Functionalization of Free-Standing Carbon Nanotubes Electrodes.](#)

s02-036

David Inwood (School of Chemistry, University of Southampton, Southampton, United Kingdom), Andrea Russell, Alex Bonastre, Jonathan Sharman

[Characterisation of the Near Surface Region of Acid Leached Pt Alloy Nanoparticles for Fuel Cell Catalysts](#)

s02-037

Young-Eun Jeon (Chemistry Education, Seoul National University, Seoul, Korea) Hun-Gi Hong

[Fabrication of Prussian Blue on poly\(p-phenylenediamine\) coated Multi-walled carbon nanotubes for electrochemical detection of hydrogen peroxide](#)

s02-038

Liu Jinhuai (Nanomaterials and Environmental Detection Laboratory, Institutes of Intelligent Machines, CAS, Hefei, Anhui Province, China)

[Facet-Dependent Electrochemical Performance of \$\alpha\$ -Fe₂O₃ Nanocrystals toward Heavy Metals Ions](#)

s02-039

Suhee Kim (Chemistry, Kyungpook National University, Daegu, Korea), Farhana Sharmin Diba, Hye Jin Lee

[Amperometric Nanobiosensors for H5N1 Proteins](#)

s02-040

Jianyun Liu (Department of Environmental Engineering, Donghua University, Shanghai, China)

[Electrospun ZnO nanofibers for determination of trace heavy metals](#)

s02-041

Lucia Mascaro (Chemistry, Rua Major Jose Inaio, Sao Carlos, Brazil), Lorena Goulart, Roger Gonçalves, Alessandra Correa, Ernesto C. Pereira

[Ag-nanoparticles/Carbon Nanotubes Composites for Electrochemical Sensor of Hydroquinone, Catechol, Bisphenol A and Phenol](#)

s02-042

Fernando C. Moraes (Chemistry Department, Federal University of São Carlos, São Carlos, Brazil), Diego Golinelli, Fernando Cincotto, Sergio Machado

[Electrochemical Sensor Based on Reduced Graphene Oxide Modified with Palladium Nanoparticles for Determination of Antidepressants](#)

s02-043

Hiroaki Ozawa (Department of Applied Chemistry, Chuo University, Tokyo, Japan), Shota Oka, Norihiko Katori, Masa-aki Haga

[Electrochemical behavior of H-bonded supramolecular polymer of ruthenium complexes on HOPG surface](#)

s02-044

Luci Rocha Aveiro (LEMN - Lab. Electroch. and Nanostructured Materials, Universidade Federal do ABC - UFABC, Santo André, Brazil), Vanessa da Silva Antonin, Mauro Coelho dos Santos

[Oxygen Reduction Reaction Catalyzed by Titanium Dioxide Supported on Carbon in Alkaline Medium](#)

s02-045

Abbasali Rostami (Faculty of Chemistry, Department of Physical Chemistry, University of Mazandaran, Babolsar, Iran), Hussein Rostami

[Poly \(p-phenyldiamine/TiO₂\) nanocomposite promoted Pt/C catalyst for methanol and ethanol electrooxidation in alkaline medium](#)

s02-046

Abbasali Rostami (Department of Physical Chemistry, University of Mazandaran, Babolsar, Iran), Majeed Sedighi

[Synthesis of Pt-CeO₂-MWCNT nanocatalysts and investigation of theirs performance for chemical degradation Mitigation of proton exchange membrane fuel cell](#)

s02-047

Natalia Rostkowska (Department of Electrode Processes, Institute of Physical Chemistry, Polish Academy of Sciences, Warsaw, Poland), Joanna Dolinska, Marcin Holdynski, Sheng-Hui Wu, Chi-Chang Hu, Marcin Opallo

[Electrooxidation of selected organic compounds at electrodes modified with nitrogen doped reduced graphene oxide: The effect of decoration with carbon nanoparticles](#)

s02-048

Ozge Surucu (Chemistry, Hacettepe University, Ankara, Turkey), Gulcin Bolat, Serdar Abaci

[Electrochemical Studies on the Interaction between \(E\)-4-\(\(6-methoxybenzo \[d\]thiazol-2-yl\)diazonyl\)-N-phenylaniline \(MBDPA\) and Bovine Serum Albumin](#)

s02-049

Mihaela Tertis (Analytical Chemistry, Iuliu Hatieganu University of Medicine and Pharmacy, Cluj-Napoca, Romania), Anca Florea, Robert Sandulescu, Cecilia Cristea

[Molecularly Imprinted Polymer Based Platform for the Electrochemical Determination of Dopamine](#)

s02-050

Richard Webster (School of Physical and Mathematical Sciences, Nanyang Technological University, Singapore, Singapore), Ya Yun Chan, Alex Eng, Martin Pumera

[Assessing the Drop Casting Method for Coating Electrodes with Nanomaterials](#)

s02-051

Julia Witt (Department of Chemistry, Carl von Ossietzky University of Oldenburg, Oldenburg, Germany), Daniel Mandler, Gunther Wittstock

[Nanoparticle Imprinted Polymers](#)

s02-052

Pei Meng Woi (Chemistry, University of Malaya, Kuala Lumpur, Malaysia), Pooria Moozarm Nia, Yatimah Alias

[One-Step Electrodeposition of Polypyrrole-Copper Nano Particles for H₂O₂ Detection](#)

Nanochemistry and nanotechnology approaches for enhancing analytical signals

s02-053

Vasilica Badets (Nanosystemes Analytiques, Université de Bordeaux, ISM-CNRS UMR 5255, Bordeaux, France), Neso Sojic, Stephane Arbault

[Effect of Oxygen Plasma Treatment of Platinized Microelectrodes on the Detection of Reactive Oxygen-Nitrogen Species](#)

s02-054

Paolo Bollella (Chemistry and Drug Technologies, Sapienza University of Rome, Rome, Italy), Roland Ludwig, Lo Gorton, Riccarda Antiochia

[Synthesis and Characterization of “Green” Metallic Nanoparticles with Tunable Charge for Development of Electrochemical Biosensors](#)

s02-055

Adriana Correia (Analytical Chemistry and Physical Chemistry, Federal University of Ceara, Fortaleza, Brazil), Wyslley Paiva, Thiago Oliveira, Suely Castro

[Sensitive Electrochemical Sensor for Imidacloprid based on Cobalt Hexacyanoferrate Film Modified Glassy Carbon Electrode](#)

s02-056

Laura Folkertsma-Hendriks (BIOS, Lab on a Chip Group, University of Twente, Enschede, Netherlands), Kaihuan Zhang, Mark Hempenius, Julius Vancso, Albert van den Berg, Mathieu Odijk

[Impedance spectroscopy of redox-active porous membranes](#)

s02-057

Kosuke Ino (Graduate School of Environmental Studies, Tohoku University, Sendai, Japan), Yusuke Kanno, Hitoshi Shiku, Tomokazu Matsue

[Molecular electrochemical switching with nano- and microstructures for electrochemical bioimaging of cells](#)

s02-058

Sharareh Sajjadi (Department of Biology, Faculty of Sciences, Roudehen Branch, Islamic Azad University, Roudehen, Iran), Mohammad Mahdi Habibi, Raziye Ramezani Karimi

[Amperometric Determination of Hydrogen Peroxide Using a Glassy Carbon Electrode Modified with a Nanocomposite of Carbon Nanotube, Ionic Liquid, Prussian Blue and Gold Nanoparticle](#)

s02-059

Francisco Trivinho-Strixino (Departamento de Física, Química e Matemática, Universidade Federal de São Carlos - Campus Sorocaba, Sorocaba, Brazil), Leticia M.M. Ferro, Sherlan S. Lemos, Marystela Ferreira

[Use of multivariate analysis on Fabry-Pérot interference spectra of nanoporous anodic alumina glucose optical sensor](#)

s02-060

Maria Valnice Boldrin Zanoni (Analytical Chemistry, Institute of Chemistry, Universidade Estadual Paulista, Araraquara, Brazil), Guilherme Bessegato, Felipe Hudari

[A New Electroanalytical Approach to Semiconductor Self-doped TiO₂ Nanotubes Electrodes](#)

Nanoelectrodes: formation, characterization and applications

s02-061

Anja Bieberle-Hütter (Solar Fuels, DIFFER, Eindhoven, Netherlands), Rochan Sinha, Irem Tanyeli, Reinoud Lavrijsen, Richard van de Sanden

[Plasma Nanostructuring: The way towards high performing photoelectrodes?](#)

s02-062

Zhuang Cai (College of Materials Science and Chemical Engineering, Harbin Engineering University, Harbin, China), Guiling Wang, Dongming Zhang

[Platinum Nanoparticles anchored on TiO₂/C Nanowires as a High Performance Catalyst for Hydrogen Peroxide Electroreduction](#)

s02-063

Gihoon Cha (Materials Science, Institute for Surface Science and Corrosion LKO FAU, Erlangen, Germany), Marco Altomare, Patrik Schmuki

[Optical Properties of Free-standing Anodic TiO₂ Nanotube Membranes](#)

s02-064

Gihoon Cha (Materials Science, Institute for Surface Science and Corrosion LKO FAU, Erlangen, Germany), Marco Altomare, Patrik Schmuki

[Double open-ended TiO₂ nanotube arrays: Formation and optical properties](#)

s02-065

Aliasghar Ensafi (Chemistry, Isfahan University of Technology, Isfahan, Iran)

[Nickel Nanoparticles Supported on Porous Silicon Flour, Application as a Non-Enzymatic Electrochemical Glucose Sensor](#)

s02-066

Imgon Hwang (Department of Materials and Engineering, FAU, WW4-LKO, Erlangen, Germany), Seulgi So, Anca Mazare, Patrik Schmuki

[Enhanced Photoelectrochemical Properties of TiCl₄-treated Single-walled TiO₂ Nanotubes](#)

- s02-067
Hwakyeung Jeong (Department of Chemistry, Chungbuk National University, Cheongju, Korea), Jongwon Kim
[Electrochemical SERS investigation of formic acid oxidation at Pt layers on Au](#)
- s02-068
Soochan Kim (School of Chemical Engineering, Sungkyunkwan University, Suwon, Korea), Won Bin Kim, Sang Ha Lee, Misuk Cho, Youngkwan Lee
[Ultra-sensitive determination of glucose based on hierarchical nickel sulfide nanostructure](#)
- s02-069
Won Bin Kim (School of Chemical Engineering, Sungkyunkwan University, Suwon, Korea), Sang Ha Lee, Soochan Kim, Misuk Cho, Youngkwan Lee
[Electrochemical biosensor based on copper sulfide dendrite for determination of glucose](#)
- s02-070
Jens Klein (Institute of Surface Chemistry and Catalysis, University Ulm, Ulm, Germany), Sylvain Brimaud, R. Jürgen Behm
[Bulk CO oxidation on Pt modified Ru\(0001\) model electrodes –The role of PtRu ensembles at the atomic scale level](#)
- s02-071
Venkata Jagadeesh Rachuri (Soft Condensed Matter, Raman Research Institute, Bengaluru, India), V. Lakshminarayanan
[Enhanced electro – oxidation of ethanol in alkaline medium studied on Pd dispersed graphite and exfoliated graphite electrodes](#)
- s02-072
En Ning Saw (Faculty for Chemistry and Biochemistry, Ruhr-University Bochum, Bochum, Germany), Kristina Tschulik
[Single Nanoparticle Analysis - Effect of Applied Potential on ‘Nano-Impact’ Spike Shapes](#)
- s02-073
Congying Song (College of Materials Science and Chemical Engineering, Harbin Engineering University, Harbin, China), Guiling Wang, Dongming Zhang, Dianxue Cao
[Uniform Growth of PtCo Modified Co₃O₄ Nanosheets as a Highly Efficient Catalyst for Sodium Borohydride Electrooxidation](#)
- s02-074
Angela Maria Stortini (Department of Molecular Sciences and Nanosystems, Università Ca’ Foscari Venezia, Venezia Mestre, Italy)
[Arrays of Copper Nanowire Electrodes for the Sensitive Electroanalysis of Nitrate](#)
- s02-075
Bin Wang (College of Materials Science and Chemical Engineering, Harbin Engineering University, Harbin, China), Guiling Wang, Dongming Zhang
[A flexible and high effective paper based gold electrode for sodium borohydride electrocatalysis](#)
- s02-076
Tao Yuan (Analytical Biochemistry, 550 Esdoornlaan, Groningen, Netherlands)
[Metabolic conversion of lidocaine by nanoporous gold electrodes](#)

Ultra-thin films

- s02-077
Barak D.B. Aaronson (Department of Chemistry, University of Bath, Bath, United Kingdom), Daping He, Mariolino Carta, Richard Malpass-Evans, Neil B. McKeown, Frank Marken
[Hierarchical Structures and Photoactive Materials in Polymers of Intrinsic Microporosity](#)
- s02-078
Abdelkader Benchettara (Department of Chemistry, USTHB, Algiers, Algeria), Abdelhakim Benchettara
[Electrochemical sensor based on Glassy Carbon Electrode Modified With Nickel Oxides for Simultaneous Determination Of Glucose and Ethanol](#)

s02-079

Duduzile Nkosi (Applied Chemistry, University of Johannesburg, Johannesburg, South Africa)[Electrochemical Properties of Self-Assembled Monolayers of Single-Walled Carbon Nanotubes on Solid Surfaces](#)

s02-080

Yuhua Shen (School of Chemistry and Chemical Engineering, Anhui University, Hefei, China), Chen Chen, Anjian Xie[A Highly Selective Biosensor for Cholesterol Detection by Combination of SAM Technique and Molecule Imprinting Method](#)

Symposium 3 New Approaches for Interfacing Electrochemistry and Biological Systems

bioelectrocatalysis

s03-001

Sofiene Abdellaoui (Chemistry, University of Utah, Salt Lake City, USA), Victoria Russel, Shelley Minter[Directed evolution of oxalate decarboxylase for enhancement of the hybrid enzymatic and organic electrocatalytic cascade](#)

s03-002

Priscilla Baker (SensorLab, Chemistry Department, University of the Western Cape, Bellville, South Africa)[Nanostructured polyamic acid transducers in the design of site directed electro-analytical technology for TB detection](#)

s03-003

Chiara Di Bari (Bioelectrocatalysis, Institute of Catalysis and Petrochemistry, Madrid, Spain), Asier Goñi-Urtiaga, Marcos Pita, Sergey Shleev, Miguel D. Toscano, Raquel Sainz, Antonio L. De Lacey[Fabrication of High Surface Area Graphene Electrodes with High Performance Towards Enzymatic Oxygen Reduction](#)

s03-004

Maria Komkova (Materials Science, M.V. Lomonosov Moscow State University, Moscow, Russia), Arkady Karyakin[Self-Powering Properties of the Prussian Blue-Based \(Bio\)sensors](#)

s03-005

Huaiguang Li (Center for Electrochemical Sciences - CES, Ruhr University Bochum, Bochum, Germany), Darren Buesen, Rhodri Williams, Frank Müller, Joerg Henig, Martin Winkler, Thomas Happe, Nicolas Plumeré[Transferring Monodispersity from the Nanoscale to the Microscale – Dendrimers as Building Blocks for Redox Hydrogel Films.](#)

s03-006

Fred Lisdat (Biosystems Technology, University of Applied Sciences Wildau, Wildau, Germany), Lena Geist, Kai R. Stieger, Andreas Wiese, Mahdi Hejazi, Peter Crowley, Athina Zouni, Fred Lisdat[Direct electrochemistry of copper containing redox proteins from photosynthesis with modified electrodes](#)

s03-007

Ievgen Mazurenko (Laboratory of Bioenergetics and Protein Engineering, CNRS - Aix-Marseille University, Marseille, France), Karen Monsalve, Jad Rouhana, N. Mano, Elisabeth Lojou[Rationalization of Carbon Nanomaterial/Enzyme Interaction for Efficient Bioelectrodes: a Multidisciplinary Approach](#)

s03-008

Jose Luis Olloqui Sariego (Physical Chemistry, Espartinas 13, Sevilla, Spain), Galina S. Zakharova, Andrey A. Poloznikov, Juan José Calvente, Dmitry M. Hushpalian, Lo Gorton, Rafael Andreu

[Potential Induced Inactivation of Immobilized Tobacco Peroxidase in the Presence of Low Hydrogen Peroxide Concentration](#)

s03-009

Ewelina Seta (Department of Chemistry, University of Warsaw, Warsaw, Poland), Weronika A. Lotowska, Iwona A. Rutkowska, Pawel J. Kulesza, Adrianna Raczowska, Katarzyna Brzostek

[Bacterial Biofilm as Active Matrix for Noble Metals Nanoparticles: Enhancement of Electroreduction of Carbon Dioxide](#)

s03-010

Till Siepenkoetter (Chemical and Environmental Science, University of Limerick, Limerick, Ireland), Urszula Salaj-Kosla, Edmond Magner

[Tunable Nanoporous Gold Electrodes and their application in Protein Electrochemistry](#)

s03-011

Yonghai Song (College of Chemistry and Chemical Engineering, Jiangxi Normal University, Nanchang, China), Juan He, Li Wang

[Cu-Hemin MOFs/Chitosan-Reduced Graphene Oxide Nanocomposites with Enzyme Activity for Electrochemical Sensing](#)

s03-012

Michal Wagner (Department of Chemistry, Technical University of Denmark, Kgs. Lyngby, Denmark), Katrine Qvortrup, David Tanner, Jens Ulstrup, Jingdong Zhang

[Quinone-Enriched Gold Nanoparticles in Bioelectrochemistry and Charge Storage](#)

s03-013

Aysu Yarman (Institute of Biochemistry and Biology, University of Potsdam, Potsdam, Germany), Bettina Neumann, Katharina J. Jetzschmann, Frieder W. Scheller

[MIP-Enzyme Combinations for Paracetamol and Phenacetin](#)

s03-014

Ling Zhang (Department of Chemistry, Technical University of Denmark, Lyngby, Denmark), Jingdong Zhang, Jens Ulstrup

[Electrochemistry of Iron Porphyrin Monolayers on Au\(111\)-electrode Surfaces](#)

Biofuel cells

s03-015

Sabine Alsaoub (Analytical Chemistry - Center for Electrochemical Sciences, Ruhr-Universität Bochum, Bochum, Germany), Adrian Ruff, Piyanut Pinyou, Felipe Conzuelo, Dmitry Pankratov, Roland Ludwig, Sergey Shleev, Wolfgang Schuhmann

[Redox-Polymers Revealing Low and High Redox Potentials and Their Application in Enzyme Based Bio-Batteries](#)

s03-016

Achraf Blout (LRS-LISE, Université Pierre et Mair Curie (Paris 6), Paris, France), Alain Pailleret, Hubert Perrot, Claude Jolivald

[Graphite/amorphous carbon nitride electrode for laccase-catalysed oxygen reduction by direct electron transfer](#)

s03-017

Tim Bobrowski (Analytical Chemistry - Center for Electrochemical Sciences, Ruhr-Universität Bochum, Bochum, Germany), Elena Gonzalez-Arribas, Dmitry Pankratov, Chiara Di Bari, Marcos Pita, Antonio Lopez De Lacey, Wolfgang Schuhmann, Sergey Shleev

[Transparent ITO nanoparticle modified ITO electrodes – utilization for enzymatic fuel cells and biocapacitors](#)

s03-018

Adalgisa De Andrade (Chemistry Department, University of São Paulo- FFCLRP-USP, Ribeirão Preto, Brazil), Carolina Bonfim, Paula G. Fenga

[The role of different anchoring agents in the architecture of ADH/NAD⁺ bioanode](#)

s03-019

Valentina Grippo (Chemistry Department, Warsaw University, Warsaw, Poland), Kalso Hussein, Su Ma, Roland Ludwig, David Hernandez Santos, Renata Bilewicz

[Enzymatic Thin Layer Flow-Cell with Screen-Printed Electrodes: Approach for Simple Miniaturized Biofuel Cell](#)

s03-020

Yoo Seok Lee (School of Environmental Science and Engineering, Gwangju Institute of Science and Technology, Gwangju, Korea), Junyeong An, Bongkyu Kim

[Sediment Microbial Fuel Cells as a Portable Power Source: Series Connection of SMFCs Using a Dipole-Electrode and Controlling Voltage Reversal](#)

s03-021

Francesca Lopez (Analytical Chemistry - Center for Electrochemical Sciences, Ruhr-Universität Bochum, Universitätsstr. 150, Bochum, Germany)

[Multilayer electrode architectures for the selective amperometric detection of lactose in the presence of high glucose concentrations](#)

s03-022

Nikola Markovic (Analytical Chemistry - Center for Electrochemical Sciences, Ruhr-Universität Bochum, Bochum, Germany), Felipe Conzuelo, Wolfgang Schuhmann

[D – Hierarchically Structured Carbon Cloth Coated with PTFE for Air-Breathing Bioelectrode Applications](#)

s03-023

Kosuke Nishida (Faculty of Mechanical Engineering, Kyoto Institute of Technology, Kyoto, Japan), Takuya Nakamura, Kazuki Sakamoto, Shodai Sunami

[Effect of Microporous Structure on Reaction Interface Formation and Mass Transport in Enzyme Immobilization Electrode for Biofuel Cell](#)

s03-024

Marc Riedel (Biosystems Technology, Institute of Applied Life Sciences, Technical University of Applied Sciences Wildau, Wildau, Germany), Gero Göbel, Jennifer Mundhenk, Matias Lara Beltram, Jörg J. Schneider, Fred Lisdat

[Influence of human body liquids on the output of an enzymatic glucose/oxygen biofuel cell based on direct electron transfer](#)

s03-025

Isao Shitanda (Department of Pure and Applied Chemistry, Faculty of Science and Technology, Tokyo University of Science, Noda-shi, Chiba, Japan), Risa Iwashita, Misayki Momiyama, Saki Nohara, Seiya Tsujimura, Yoshinao Hoshi, Masayuki Itagaki

[Improvement of Output Power of Paper-based Wearable Biofuel Cell by 3D Electrode and Array Structures](#)

s03-026

Krzysztof Stolarczyk (Faculty of Chemistry, Warsaw University, Warsaw, Poland), Michal Kizling, Renata Bilewicz

[Bioelectrodes Modified with Carbon and Metal Nanomaterials for Biofuel Cells](#)

s03-027

Rebecka Werchmeister (Department of Chemistry, Technical University of Denmark, Kgs. Lyngby, Denmark), Fei Shen, Jingdong Zhang

[Graphene paper based bioelectrodes for enzymatic biofuel cells](#)

Biological membranes

s03-028

Dan Bizzotto (Chemistry, The University of British Columbia, Vancouver, Canada), Amanda Musgrove
[In-situ Fluorescence and AFM Imaging Studies of Electrochemical Control Over the Incorporation of DOPC Liposomes onto an octadecanol coated Au\(111\) surface](#)

s03-029

Nadica Ivosevic De Nardis (Division for Marine and Environmental Research, Ruder Boskovic Institute, Zagreb, Croatia), Jadranka Pecar Ilic, Ivica Ruzic, Galja Pletikapic
[Adhesion and Spreading of a Cell at a Charged Interface](#)

s03-030

Monika Naumowicz (Department of Electrochemistry, Institute of Chemistry, University of Bialystok, Bialystok, Poland), Aneta Petelska
[Physicochemical modelling of the surface-active phospholipid bilayer relative to acid-base equilibria](#)

s03-031

Ashley Page (Department of Chemistry, University of Warwick, Coventry, United Kingdom), Alexander Armitstead, David Perry
[Multifunctional Scanning Electrochemical Probe Microscopy as a Tool to Visualise Cellular Uptake with Nanoscale Resolution](#)

s03-032

Aneta Petelska (Department of Electrochemistry, Institute of Chemistry, University of Bialystok, Bialystok, Poland), Monika Naumowicz
[The equilibria of phosphatidylcholine-divalent ions in monolayer at the air/water interface](#)

s03-033

Lukasz Poltorak (ChemE, TU Delft, Delft, Netherlands), Louis de Smet, Ernst Sudhölter
[Electrochemical Impedance Spectroscopy of lipid bilayers cushioned on doped silicon surfaces](#)

s03-034

Javier Roman (Instituto de Química, Pontificia Universidad Católica de Valparaíso, Valparaíso, Chile), Emilio Navarrete, Eduardo Muñoz
[Study about Overall Adhesion-Spreading Process of Liposomes on a Gold Electrode. Influence of the Presence of CdTe Quantum Dots](#)

Biomaterials

s03-035

Egor Andreev (Chemistry Faculty, M.V. Lomonosov Moscow State University, Moscow, Russia), Maria Komkova, Arkady Karyakin
[Electrochemical Detection of Penicillium chrysogenum by Conductivity Increase of Boronate-Substituted Polyaniline](#)

s03-036

Francisco Armijo (Facultad de Química, Pontificia Universidad Católica de Chile, Santiago, Chile), Erick Castañeda, Francisco Martinez, Maria Angelica del Valle, Mauricio Isaacs
[Poly\(3,4-ethylenedioxythiophene\) / polydopamine as a new platform for the development of electrochemical immunosensors](#)

s03-037

Aruã Clayton da Silva (Department of Chemistry, Universidade de São Paulo, São Paulo, Brazil), Leandro Helgueira Andrade, Susana Cordoba de Torresi
[Green Synthesis and Characterization of a New Conducting and Biodegradable Copolymer of PEDOT-co-PLLA as Biomaterial](#)

s03-038

Joanna Dolinska (Department of Electrode Processes, Institute of Physical Chemistry Polish Academy of Sciences, Warsaw, Poland), Marcin Holdynski, Marcin Opallo
[How to cook electrocatalytically active nanoparticles?](#)

s03-039

Min-Sheng Hung (Department of Biomechatronic Engineering, National Chiayi University, Chiayi, Taiwan), Yi-Ming Zhao

[A Micro-orifice Platform Integrated with Dielectrophoresis for Phalaenopsis Protoplasts Pairing and Electrofusion](#)

s03-040

Laszlo Kekedy-Nagy (Nature and Technology, Aarhus University, Aarhus, Denmark), Elena E. Ferapontova

[Importance of a Dual Charge on the DNA-Conjugated Redox Probe for Diffusional Voltammetry of DNA Duplexes Tethered to Gold Electrodes](#)

s03-041

Inmaculada Marquez (Physical Chemistry, University of Sevilla, Sevilla, Spain), Jose Luis Olloqui Sariago, Estrella Frutos Beltrán, Miguel A. De la Rosa, Juan José Calvente, Antonio Díaz-Quintana, Rafael Andreu

[Effect of a Remote Residue Mutation on the Electron Transfer of Plastocyanin Immobilized on a Cysteamine Modified Gold Electrode](#)

s03-042

Gilbert Nöll (Chemistry-Biology, University of Siegen, Siegen, Germany), Cristina Gutierrez Sanchez, Qiang Su, Stephan Vogt

[Electrochemically Switchable Protein-DNA Layers](#)

Enzymes

s03-043

Pablo Fanjul Bolado (R&D, DropSens, S.L., Llanera, Spain), Marta Maria Pereira da Silva Neves, Pablo Bobes Limenes, Alejandro Pérez Junquera, María Begoña González García, David Hernandez Santos

[Miniaturized Analytical Instrumentation for Electrochemiluminescence Assays: a Spectrometer and a Photodiode based Device](#)

s03-044

Deby Fapyane (Nanoscience-iNANO, Aarhus University, Aarhus, Denmark), Elena E. Ferapontova

[Bioelectrocatalytic Oxidation of Glucose by Hexose Oxidase Directly Wired to Graphite](#)

s03-045

Katharina J. Jetzschmann (Institute of Biochemistry and Biology, University Potsdam, Golm, Germany), Aysu Yarman, Martin Rohloff, Vlada Urlacher, Anna Fischer, Ulla Wollenberger, Frieder W. Scheller

[Molecular imprinting of the oxygenase domain of cytochrome P450 BM3](#)

s03-046

Faduma Maddar (Chemistry, University of Warwick, Coventry, United Kingdom), Robert Lazenby, Patrick Unwin

[Surface-structure controls of the electro-oxidation of NADH at carbon electrodes: Highly oriented pyrolytic graphite \(HOPG\) and polycrystalline boron-doped diamond \(pBDD\)](#)

s03-047

Marta Meneghello (Chemistry, University of Southampton, Southampton, United Kingdom), Firas Al-Lolage, Su Ma, Roland Ludwig, Philip Bartlett

[Covalent immobilization of engineered Cellobiose Dehydrogenase from *Myriococcus thermophilum*](#)

s03-048

Biljana Mitrova (Institute of Biochemistry and Biology, University of Potsdam, Potsdam, Germany), Tobias Hartmann, Silke Leimkühler, Ulla Wollenberger

[Voltammetry of Formate Dehydrogenase from *R. capsulatus*-a Molybdoenzyme Capable of CO₂ Fixation and Biofuel Production](#)

s03-049

Bettina Neumann (Institute for Biochemistry and Biology, University Potsdam, Potsdam, Germany), Lina Rustam, Anna Fischer, Frieder W. Scheller, Ulla Wollenberger

[Spectroelectrochemistry of Microperoxidase-11 in Transparent Electrodes](#)

s03-050

Stefanie Stapf (Analytical Chemistry, Ruhr-Universität Bochum, Bochum, Germany), Wolfgang Schuhmann, Nicolas Plumeré, Adrian Ruff, Olaf Rüdiger, Wolfgang Lubitz

[Viologen Polymers for Reversible Hydrogen Oxidation and Hydrogen Generation in Redox Hydrogels](#)

Nucleic Acids

s03-051

Fethi Bedioui (Technologies Chimiques et Biologiques pour la Santé, CNRS, Chimie ParisTech, INSERM, Univ. Paris Descartes, Paris, France), Achille Nassi, François Xavier Guillon, Bernard Hainque, S. Amriche, D. Maugé, Eva Markova, Chantal Tsé, Pascal Biglé, Mathieu Lazerges

[Electrochemical DNA-Biosensors Based on Long-Range Electron Transfer: Optimization of the Amperometric Detection in the Femtomolar Range Using 2-Electrode Setup](#)

s03-052

Zhanna Boeva (Faculty of Science and Engineering, Åbo Akademi University, Turku, Åbo, Finland), Tom Lindfors, Vladimir Sergeyev, Kalle Levon

[Protonation constant of polyaniline – a key for developing an efficient biosensor](#)

s03-053

Bogdan Feier (Analytical Chemistry, Faculty of Pharmacy, “Iuliu Hatieganu” University of Medicine and Pharmacy, Cluj-Napoca, Romania), Cecilia Cristea, Robert Sandulescu

[Electrochemical Aptasensor for the Detection of Ampicillin](#)

s03-054

Lance Ho (Biotechnology Innovation Centre, Rhodes University, Grahamstown, South Africa), Ronen Fogel, Janice Limson

[An Evaluation of Gold Pre-treatment for a Streptavidin-biotin-based Electrochemical Impedance Thrombin Aptasensor](#)

s03-055

Andrea Hájková (Department of Analytical Chemistry, Charles University in Prague, Prague, Czech Republic), Jiří Barek, Vlastimil Vyskočil

[DNA Damage Induced by Hydroxyl Radicals and Auto-Oxidation of Fe\(II\) Detected by an Electrochemical DNA Biosensor](#)

s03-056

Daliborka Jambrec (Analytical Chemistry, Center for Electrochemical Sciences, Ruhr University Bochum, Bochum, Germany), Felipe Conzuelo, Arturo Estrada-Vargas, Bianca Ciui, Yasin Ugur Kayran, Cecilia Cristea, Wolfgang Schuhmann

[Optimizing DNA Assays. DNA Sensor Preparation in Minutes](#)

s03-057

Dominika Janiszek (Faculty of Chemistry, University of Warsaw, Warsaw, Poland), Monika Karpinska, Andrzej Niewiadomy, Agnieszka Girstun, Hanna Elzanowska, Magdalena Maj-Zurawska, Pawel J. Kulesza

[Does Pentamidine Interact with Plasmid DNA Similarly to Some Anticancer Drugs?](#)

s03-058

Adriana Palinska-Saadi (Faculty of Chemistry, University of Warsaw, Warsaw, Poland), Magdalena Lukasiewicz, Janusz Oszczapowicz, Małgorzata Lukawska, Irena Oszczapowicz, Elzbieta Zwierkowska, Selim Achmatowicz, Magdalena Maj-Zurawska

[DNA Interactions with Daunorubicin and Its Formamidino Derivatives Studied by Voltammetric and Spectrophotometric Methods](#)

s03-059

Tsvetan Hristov Tarnev (Analytische Chemie, Ruhr-Universität Bochum, Bochum, Germany), Jan Clausmeyer, Daliborka Jambrec, Alexander Botz, Wolfgang Schuhmann

[High-Resolution Shear-Force Scanning Electrochemical Microscopy Studies on DNA-Modified Gold Surfaces](#)

s03-060

Mats de Jong (Chemistry, University of Antwerp, Antwerp, Belgium), Nick Slegers, Jayoung Kim, Filip Van Durme, Nele Samyn, Joseph Wang, Karolien De Wael

[Portable Voltammetric sensor for Fast, Sensitive and Selective On-site Screening of Cocaine](#)

Photobioelectrochemistry

s03-061

Gaochao Fan (School of Chemistry and Chemical Engineering, Nanjing University, Nanjing, China), Jianrong Zhang, Junjie Zhu

[Enhanced Photoelectrochemical Immunosensing Platform Amplified by CuS Nanocrystals Conjugated Signal Antibodies](#)

s03-062

Yanyan Song (Research Center for Analytical Sciences, Northeastern University, Shenyang, China), Jingwen Xu, Zhida Gao

[Controllable Antibacterial Platform based on TiO₂ Nanotube Arrays: from UV Light to Visible Light Triggered Drug Release System](#)

s03-063

Chiaki Terashima (Photocatalysis International Research Center, Tokyo University of Science, Chiba, Japan), Asako Kuragano, Kensuke Katagishi, Anitha Devadoss, P. Sudhagar, Takeshi Kondo, Isao Shitanda, Kazuya Nakata, Ken-ichi Katsumata, Norihiro Suzuki, Masayuki Itagaki, Makoto Yuasa, Akira Fujishima

[Photoelectrochemical Sensing of Biomolecules at Au-TiO₂ Photoanode](#)

s03-064

Junjie Zhu (School of Chemistry and Chemical Engineering, Nanjing University, Nanjing, China), Jianrong Zhang, Gaochao Fan

[Development and Application of the Photoelectrochemical Biosensors](#)

Symposium 4 Electrochemical Approaches in Diseases and Human Health

Brain

s04-001

Anca Florea (Analytical Chemistry Department, University of Medicine and Pharmacy Iuliu Hatieganu, Cluj-Napoca, Romania)

[Novel Gold Nanostructured Aptasensor for the Electrochemical Detection of Dopamine](#)

Cell Signaling

s04-002

J. Justin Gooding (The Australian Centre for NanoMedicine, School of Chemistry, Sydney, Australia), Maryam Parviz, Katharina Gaus

[A dual optical and electrochemical system for monitoring cell surface interactions and the response of cells to therapeutics](#)

Diagnosis

s04-003

Anton Ciucu (Analytical Chemistry, University of Bucharest, Bucharest, Romania), Andreea Rabanca, Mihaela Buleandra

[Sensors Development for Neurotransmitters Determination](#)

s04-004

M.C. Dilusha Cooray (School of Chemistry, Monash University, Clayton, Australia), Saman Sadanayake, Fengwang Li, Steven J. Langford, Alan M. Bond, Jie Zhang

[Efficient Enzymatic Oxidation of Glucose Mediated by Ferrocene Covalently Attached to Polyethylenimine Stabilized Gold Nanoparticles](#)

s04-005

Cecilia Cristea (Analytical Chemistry, Iuliu Hatieganu University of Medicine and Pharmacy, Cluj-Napoca, Romania), Mihaela Tertis, Luminita Fritea, Anca Florea, Robert Sandulescu

[Design of Immobilization Platforms for Sensors Used in Pharmaceutical Analysis](#)

s04-006

Frédérique Deiss (Chemistry and Chemical Biology, IUPUI, Indianapolis, USA), Isaac Taylor

[An Electrochemical Paper-based Device for Micronutrient Sensing Applied to the Point-of-care Quantification of Potassium Ion](#)

s04-007

Janice Limson (Biotechnology Innovation Centre, Rhodes University, Grahamstown, South Africa), Ronen Fogel, Kelly-Anne Frith, Mary Cromhout, Tamika Fellows

[Generating and validating aptamers for low-cost diagnostics](#)

s04-008

Candice Rassie (Chemistry, University of the Western Cape, Cape Town, South Africa), Priscilla Baker, Emmanuel Iwuoha

[Multichannel electrochemical CYP2E1 enzyme phenotype-biosensor system for the determination of TB drug metabolism](#)

s04-009

Yuko Ueno (Molecular and Bio Science Research Group, NTT Basic Research Laboratories, NTT Corporation, Atsugi, Japan), Ziyang Xu, Kazuaki Furukawa

[Electrochemistry at the Edge and Basal Plane of a Graphene Microelectrode: Fabrication and Characterization](#)

s04-011

Lindsay Wilson (Chemistry, University of the Western Cape, Cape Town, South Africa), Phillipa Randall, Candice Rassie, Tesfaye Waryo, Priscilla Baker, Keertan Dheda, Emmanuel Iwuoha

[Polyaniline based screen printed carbon electrode immunosensors for the detection of lipoarabinomannan in clinical samples.](#)

s04-012

Guobao Xu (State Key Laboratory of Electroanalytical Chemistry, Changchun Institute of Applied Chemistry, CAS, Changchun, China), Liming Qi, Wenjing Qi, Yong Xia, Wenyue Gao, Fengxia Wu, Suping Li, Saima Hanif

[Wireless Electrochemiluminescence](#)

Drug carriers

s04-013

Dorota Matyszewska (Faculty of Chemistry, University of Warsaw, Warsaw, Poland), ZhangFei Su, J. Jay Leitch, Jacek Lipkowski, Renata Bilewicz

[Phospholipid Membranes as Model Systems to Study the Interactions of Anticancer Drugs – Langmuir-Blodgett, PMIRRAS and Electrochemical Studies](#)

Medical devices

s04-014

Jaewook Baek (Department of Chemistry, Sogang University, Seoul, Korea), Enhua Zhu[Development of Implantable Drug Pump: Application of the Nongassing Electroosmotic Pump](#)

s04-015

Lucia Fernandez Macia (Department of Materials and Chemistry, Vrije Universiteit Brussel, Brussels, Belgium), Karolina Cysewska, Piotr Jasinski, Annick Hubin[Odd Random Phase Electrochemical Impedance Spectroscopy to Study the Electropolymerization and Degradation of Polypyrrole Coatings on Iron for Cardiovascular Stents](#)

s04-016

Achim Walter Hassel (CEST, ICTAS, COMBOX, Johannes Kepler University, Linz, Austria), Jan Philipp Kollender, Georg Sprinzl, Theo Doll[IPC-MS Monitoring of the Electrochemical Dissolution of Active Implants in Hearing Aids](#)

s04-017

Dominika Janiszek (Faculty of Chemistry, University of Warsaw, Warsaw, Poland), Monika Karpinska, Andrzej Niewiadomy, Agnieszka Girstun, Hanna Elzanowska, Magdalena Maj-Zurawska, Pawel J. Kulesza[Thin Redox Layers Use in DNA Sensors: Interactions with Drugs](#)

s04-018

Wesley Bruno Silva Machini (Department of Chemistry, Faculty of Science and Technology, University of Coimbra, Coimbra, Portugal), Teodor Adrian Enache, Sonia Maria Alves Jorge, Ana Maria Oliveira-Brett[Isotretinoin Oxidation Mechanism and Electroanalysis in a Pharmaceutical Drug Using a Boron-Doped Diamond Electrode](#)

s04-019

Modupe Ogunlesi (Chemistry, University of Lagos, Lagos, Nigeria), Wesley Okiei, Sulaiman Akanmu, Oluwatoyin Akerele[Studies on the effects of anti-sickling agents on the voltammetric properties of Haemoglobin S using Cyclic Voltammetry with bare Glassy Carbon Electrode](#)

s04-020

Salvatore Piazza (Dipartimento di Ingegneria Chimica Gestionale Informatica Me, Università di Palermo, Palermo, Italy), Giuseppe Blanda, Rosalinda Inguanta, Carmelo Sunseri, Francesco Carfi Pavia, Silvia Greco, Valerio Brucato

Brushite/Hydroxyapatite Coatings obtained by galvanic deposition on 316L Stainless Steel

s04-021

Woonsup Shin (Department of Chemistry, Biomedical Engineering, Sogang University, Seoul, Korea)[Application of Non-gassing Electroosmotic Pump for Developing Drug Delivery Devices](#)

s04-022

Yonghai Song (College of Chemistry and Chemical Engineering, Jiangxi Normal University, Nanchang, China), Yonggui Song, Li Wang[Design and Preparation of a Self-Potential Biosensor for in vitro and in vivo Glucose Monitoring](#)

s04-023

Masoud Taleb (Department of Materials Engineering, Tallinn University of Technology, Tallinn, Estonia), Roman Ivanov, Irina Hussainova[Novel Electrode of Graphenated Nano Fibers for Simultaneous Determination of Dopamine, Uric Acid, and Ascorbic Acid](#)

s04-024

Ching-Chou Wu (Department of Bio-industrial Mechatronics Engineering, National Chung Hsing University, Taichung, Taiwan), Chieh-Jen Wang, Lee-Tian Chang[Development of cell-based chip integrated with dissolved oxygen electrodes and its application in the estimation of adipocyte metabolism](#)

Oxidative stress

s04-025

Anna Banasiak (School of Chemical and Pharmaceutical Sciences, Dublin Institute of Technology, Dublin, Ireland), John Cassidy, John Colleran

[Investigation of the Interactions between Bioinorganic Compounds and DNA Using Electrochemical DNA Biosensors](#)

s04-026

Saustin Dongmo (Department of Chemistry, Carl von Ossietzky University of Oldenburg, Oldenburg, Germany), Janina Leyk, Christiane Richter-Landsberg, Carsten Dosche, Gunther Wittstock

[Local oxidative stress by controlled release of ROS using polymer-modified microelectrode](#)

s04-027

Paulo Cesar Ghedini (Pharmacology, Federal University of Goias, Goiania, Brazil), Elton Clementino da Silva, Dâmaris Silveira, Ruitter Moraes Lima, Gérman Sanz Lobón, Eric Gil

[Voltammetric and Spectrophotometric Determination of Antioxidant Activity of Eugenia dysenterica DC Leaves Extracts and their Pharmacological Implications](#)

s04-028

Paulo Cesar Ghedini (Pharmacology, Federal University of Goias, Goiania, Brazil), Jerônimo Raimundo de Oliveira Neto, Ruitter Moraes Lima, Gérman Sanz Lobón, Karla Carneiro de Siqueira Leite, Boniek Gontijo Vaz, Eric Gil

[Antioxidant Activity of Beer using a Carbon Paste Adenine-Biosensor](#)

s04-029

Abdulghani Ismail (Department of Chemistry, Chimie ParisTech, Paris, France), Victor Baldim, Patricia Taladriz-Blanco, Sophie Griveau, Fanny d'Orlyé, Anne Varenne, Marcelo Ganzarolli de Oliveira, Fethi Bedioui

[Quantification of S-nitrosothiols using different decomposition pathways by electrochemical and chemiluminescence detection](#)

s04-030

Frédéric Lemaître (Department of Chemistry, Ecole Normale Supérieure, Paris, France), Yun Li, Catherine Sella, Manon Guille-Collignon, Laurent Thouin, Christian Amatore

[Electrochemical Detection of Reactive Oxygen / Nitrogen Species within Microdevices](#)

s04-031

Miriam Marquitan (Analytische Chemie, Ruhr-Universität Bochum, Bochum, Germany), Jan Clausmeyer, Melanie D. Mark, Stefan Herlitze, Wolfgang Schuhmann

[Carbon nanoelectrodes for intracellular electrochemical detection of reactive oxygen species \(ROS\)](#)

s04-032

Tao Zhang (Department of Analytical Biochemistry, University of Groningen, Groningen, Netherlands)

[Efficient and Selective Chemical Labeling of Electrochemically Cleaved Peptides for Protein Analysis](#)

Symposium 5 Current Progress in Microbial Electrochemical Technologies

Microbial electrochemical technologies

s05-001

Plamen Atanassov (Center for Micro-Engineered Materials, University of New Mexico, Albuquerque, USA), Alexey Serov, Kateryna Artyushkova, Jonathan Gordon, Mounika Kodali, Santiago Rojas-Carbonell, Carlo Santoro

[Precious Metals-free Catalysts For Oxygen Reduction Reaction for Microbial Fuel Cell Cathodes](#)

s05-002

Mareike Engel (Junior Research Group BioSats, Bioprocess Engineering, University of Kaiserslautern, Kaiserslautern, Germany), Aljoscha Koch, Nils Tippkötter

[A simple bioreactor design for microbial electrosynthesis of biobutanol](#)

s05-003

Carmen María Fernandez Marchante (Chemical Engineering, Universidad de Castilla-la-Mancha, Ciudad Real, Spain), Yeray Asensio, Justo Lobato, Pablo Cañizares, Manuel Andres Rodrigo

[Influence of the fuel and dosage on the performance of double-compartment microbial fuel cells](#)

s05-004

Carmen María Fernandez Marchante (Chemical Engineering, Universidad de Castilla-la-Mancha, Ciudad Real, Spain), Yeray Asensio, Iziar Begoña Montes, Justo Lobato, Pablo Cañizares, Manuel Andres Rodrigo

[Influence of the electrode material on double-compartment microbial fuel cells fed with acetate](#)

s05-005

Sung Hee Jeong (Dept. Nano Science and Technology, Seoul National University, Suwon-Si, Korea), Soo Youn Lee

[Redox Active Scaffold-Accelerated Extracellular Electron Transfer in Microbial Fuel Cells](#)

s05-006

Bongkyu Kim (School of Environmental Science and Engineering, Gwangju Institute of Science and Technology (GIST), Gwangju, Korea), Junyeong An, Yoo Seok Lee, In Seop Chang

[“Voltage Reversal” in Microbial Fuel Cell and Ways to Reduce in Stacking Systems](#)

s05-007

Sam Molenaar (Resource Recovery, Wetsus, Leeuwarden, Netherlands)

[Microbial Rechargeable Battery: Energy Storage through Acetate](#)

s05-008

Guillermo Pozo (Advanced Water Management Centre, The University of Queensland, Brisbane, Australia), Ludovic Jourdin, Yang Lu, Pablo Ledezma, Jürg Keller, Stefano Freguia

[Real-time Electron/Mass Balances within Autotrophic Sulfate-Reducing Biocathodes](#)

s05-009

Patricia Zamora (Water Treatment and Reuse, Abengoa S.A., Seville, Spain), Inmaculada Salcedo, Philipp Kuntke, Adriaan Jeremiassen

[A pilot-scale Microbial Electrolysis Cell for ammonia recovery from urine](#)

Microbial electroconversions

s05-010

Linda Gonzalez-Gutierrez (Research, CIDETEQ, Pedro Escobedo-Sanfandila, Mexico), Eduardo Martínez-González, Nancy Velazco, Carlos Frontana

[Quinones as redox mediators in microbial bioelectrochemical reactions](#)

s05-011

Korneel Rabaey (Center for Microbial Ecology and Technology, Ghent University, Gent, Belgium), Sunil Patil, Jan Arends

[Long Term Continuous Microbial ElectroSynthesis for the Production of Acetate and Secondary Alcohol from CO₂ and Current.](#)

Symposium 6 Novel Materials and Devices for Energy Storage: Batteries for Tomorrow's World

Li-ion

s06-001

Safeer Ahmed (Chemistry, Quaid-i-Azam University, Islamabad, Pakistan), Maryam Iftekhar, Nicholas Drewett, Laurence Hardwick

[Electrochemical Performance of Lithium Manganese Rich Al and Cr Doped Cathode Materials](#)

s06-002

Hasan Algül (Department of Metallurgical & Materials Engineering, Sakarya University, Sakarya, Turkey), Mehmet Uysal, Mahmud Tokur, Seyma Ozcan, Tugrul Cetinkaya, Hatem Akbulut, Ahmet Alp

[Graphene Reinforced Sn Negative Electrodes for Li Ion Batteries](#)

s06-003

Niv Aloni (School of Chemistry, Tel-Aviv University, Tel-Aviv, Israel), Emanuel Peled, Diana Golodnitsky, Meital Goor

[SiNPs Supported on a Carbon Fibers Scaffold as Anodes for High-Capacity Lithium Ion Batteries](#)

s06-004

Monika Bakierska (Faculty of Chemistry, Jagiellonian University, Krakow, Poland), Michal Swietoslowski, Marcin Molenda

[Study on Lithium Ion Diffusivity in Modified \$\text{LiMn}_2\text{O}_4\$ Spinel-Based Cathode Materials](#)

s06-005

Prabeer Barpanda (Materials Research Center, Indian Institute of Science, Bangalore, India)

[Realization of High-Voltage Iron-Based Battery Insertion Materials](#)

s06-006

Solveig Böhme (Department of Chemistry - Ångström, Uppsala University, Uppsala, Sweden), Kristina Edström, Leif Nyholm

[Electrochemical behaviour of tin\(IV\) oxide electrodes in lithium-ion batteries at high temperature and potentials](#)

s06-007

Musa Ali Cambaz (Materials 1, Helmholtz Institute Ulm, Ulm, Germany), Maximilian Fichtner

[Vanadium oxyfluoride a new cathode material for lithium batteries](#)

s06-008

Musa Ali Cambaz (Materials 1, Helmholtz Institute Ulm, Ulm, Germany), Maximilian Fichtner

[LiFeBO₃ as a high capacity cathode material for lithium ion batteries](#)

s06-009

Candace Chan (Materials Science and Engineering, Arizona State University, Tempe, USA), Qian Cheng

[Oxidation-Reduction Assisted Exfoliation of Layered Metal Oxides into Functional Nanosheet Building Blocks for Advanced Cathode Materials](#)

s06-010

Ruiyong Chen (Joint Electrochemistry Lab, KIST Europe GmbH, Saarbruecken, Germany), Ruiyong Chen, Michael Knapp, Emad Maawad, Rolf Hempelmann

[Electrochemistry Driven Structural Transition of VO₂F into Disordered Rock-Salt](#)

s06-011

Woosuk Cho (Advanced Batteries Research Center, Korea Electronics Technology Institute, Seongnam, Korea), Yong Nam Jo, Jun-Ho Song, Young-Jun Kim

[Understanding of degradation mechanism of Ni-rich \$\text{LiNi}_x\text{Co}_y\text{Mn}_z\$ \(\$x + y + z = 1\$ \) cathode for lithium ion battery](#)

s06-012

Rajnish Dhiman (Department of Physics, Chemistry and Pharmacy, University of Southern Denmark, Odense, Denmark), Dorthe Ravnsbæk

[XPS and in operando Synchrotron X-ray diffraction studies of V₂O₅ cathode material for Li-ion batteries.](#)

s06-013

Oleg Drozhzhin (Chemistry Department, Lomonosov Moscow State University, Moscow, Russia), Vasily Sumanov, Olesia Karakulina, Artem Abakumov, Joke Hadermann, Andrey Baranov, Keith Stevenson, Evgeniy Antipov

[Switching Between Solid Solution and Two-Phase Regimes in the Li_{1-x}Fe_{1-y}MnyPO₄ Cathode Materials During Lithium \(de\)Insertion: Combined PITT, in situ XRPD and Electron Diffraction Tomography Study](#)

s06-014

Ahmed S. Etman (Department of Material and Environmental Chemistry (MMK), Stockholm University, Stockholm, Sweden), Habtom D. Asfaw, Ning Yuan, Jian Li, Zhengyang Zhou, Fei Peng, Ingmar Persson, Xiaodong Zou, Torbjörn Gustafsson, Kristina Edström, Junliang Sun

[Novel Environmentally Friendly Approach for Synthesizing Hydrated V₂O₅ Nanosheets](#)

s06-015

Elizaveta Evschik (Laboratory of solid state ionics, Institute of Problems of Chemical Physics, Chernogolovka, Russia), Dmitriy Novikov, Victor Berestenko, Anna Peshkova, Alexey Levchenko, Evgeniy Sanginov, Yuriy Dobrovolskiy

[The Stability of the Thin-Film Anodes Based on Si@SiO₂ Nanoparticles with a Different Type of Binder](#)

s06-016

Swapna Ganapathy (Department of Radiation Science and Technology, Delft University of Technology, Delft, Netherlands), Alexandros Vasileiadis, Jouke R. Heringa, Marnix Wagemaker

[The fine line between a two-phase and solid-solution transformation in Li_{4+x}Ti₅O₁₂](#)

s06-017

Johan Hagberg (Department of Chemical Engineering and Technology, KTH Royal Institute of Technology, Stockholm, Sweden), Andrzej Nowak, Leijonmarck Simon, Hannah Schweinebarth, Darren Baker, Anders Uhlin, Per Tomani, Göran Lindbergh

[Lignin Based Carbon Fibres as Negative Electrodes in Lithium Ion Batteries](#)

s06-018

Kookjin Heo (Applied Optics&Energy R&D Group, Korea Institute of Industrial Technology, Gwangju, Korea), Jeong-Seon Lee, Jinsub Lim

[Surface Modified High Capacity Ni-rich Cathode Materials for Li-ion Batteries](#)

s06-019

Anja Hoffmann (IEK-9, Forschungszentrum Jülich, Jülich, Germany), Peter Jakes, Svitlana Eurich, Desiree van Holt, L.G.J. de Haart, Hans Kungl, Ruediger-A. Eichel

[Synthesis and characterization of LiNi_xMn_{2-x}O₄ as high voltage cathode materials in lithium ion batteries](#)

s06-020

Rudolf Holze (AG Elektrochemie, Technische Universität Chemnitz, Chemnitz, Germany), Tianyu Feng, Youlong Xu, Zhengwei Zhang, Yianfeng Du, Xiaofei Sun, Lilong Xiong, Raul Rodriguez

[Al₂O₃-coatings as tailored synthetic solid electrolyte interfaces on graphite for lithium ion batteries](#)

s06-021

Min Young Hong (Graduate School of Knowledge-based Technology and Energy, Korea Polytechnic University, Sangidaehak-ro 237, Siheung-si, Korea), Duri Kim, In-Ae Oh, Young-Sang Cho, Ji Heon Ryu

[Superior Electrochemical Performance of Floorball-like Low Crystalline Macroporous TiO₂ Spherical Powders for Negative Electrode Materials](#)

s06-022

Ling Huang (College of Chemistry and Chemical Engineering, Xiamen University, Xiamen, China), Qi Wang, Chong-Heng Shen, Jun-Tao Li, Shi-Gang Sun

[Unravelling Mutual Impact between Inner-Lattice Variables and Li-Ion Diffusion of LiNi_{0.54}Co_{0.23}Mn_{0.23}O₂ under High-Voltage Charging by A Coupled In-Situ Measurement](#)

s06-023

Xiaohua Huang (College of Physics & Electronic Engineering, Taizhou University, Taizhou, China), Jianbo Wu, Weiping Chen, Yan Lin, Yiqi Cao, Renqing Guo

[Interconnected Ni Nanowalls Supported Si Film as Anode Materials for Lithium Ion Batteries](#)

s06-024

Charlotte Ihrfors (Department of Chemistry - Ångström Laboratory, Uppsala University, Uppsala, Sweden), Wei Wei, Fredrik Björefors, Leif Nyholm

[Manufacturing and electrochemical characterization of freestanding TiO₂ nanotube electrodes for lithium-ion batteries](#)

s06-025

Chinwe Ikpo (Chemistry, University of the Western Cape, Bellville, Cape Town, South Africa), Miranda Ndipingwi, Ntuthuko Wonderboy Hlongwa, Zolani Myalo, Natasha Ross, Kenneth I. Ozoemena, Priscilla Baker, Emmanuel Iwuoha

[Electrochemical Dynamics of Nanocomposite Lithium Iron Phosphate Cathode Material for Lithium Ion Batteries](#)

s06-026

Vladislav Ivanistsev (Institute of Chemistry, University of Tartu, Tartu, Estonia), Trinidad Mendez-Morales, Ruth M. Lunden-Bell, Oscar Cabeza, Luis J. Gallego, Luis M. Varela, Maxim V. Fedorov

[Molecular origin of high free energy barriers for alkali metal ion transfer through ionic liquid-graphene electrode interfaces](#)

s06-027

Svetlozar Ivanov (Electrochemistry and Electroplating Group, Ilmenau University of Technology, Ilmenau, Germany), Adriana Barylyak, Khrystyna Besaha, Anna Dimitrova, Stefan Krischok, Andreas Bund, Jaroslav Bobitski

[Enhanced Lithium Ion Storage in TiO₂ Nanoparticles. Induced by Sulphur and Carbon Co-doping](#)

s06-028

Philipp Jehnichen (Institute of Energy and Climate Research (IEK-3), Forschungszentrum Jülich GmbH, Jülich, Germany), Klaus Wedlich, Susanne Kuhri, Carsten Korte, Detlef Stolten

[Analysis of the growth of a SEI surface layer on LiNi_{0.5}Mn_{1.5}O₄ via XPS and Raman spectroscopy](#)

s06-029

Yuju Jeon (School of Energy and Chemical Engineering, Ulsan National Institute of Science and Technology (UNIST), Ulsan, Korea), Hyun Kuk Noh, Hyun-Kon Song

[Realizing 200 mAh g⁻¹ Lithium Manganese Oxide Spinel in Lithium Ion Battery Cells with Prelithiated Anode](#)

s06-030

Zhuan Ji (Sustainable Energy Laboratory, Faculty of Materials Science, China University of Geosciences, Wuhan, Wuhan, China), Bo Han, Qiyang Li, Chenggang Zhou, Qiang Gao, Kaisheng Xia, Jinping Wu

[Anchoring Lithium Polysulfides via Affinitive Interactions: Electrostatic Attraction, Hydrogen Bonding, or in Parallel?](#)

s06-031

Jian-Ting Jin (Chemical Engineering, National Taiwan University, Taipei, Taiwan), Xin-Hui Ma, Nae-Lih Wu

[A Facile Anti-Solvent Method for Synthesizing High Sulfur Content Composite for High Performance Lithium-Sulfur Batteries](#)

s06-032

Tomas Kazda (Department of Electrical and Electronic Technology, Brno University of Technology, Brno, Czech Republic), Libor Novak, Tomas Vystavel, Jiri Starek, Jiri Vondrak

[In situ scanning electron microscopy as a tool for studying structural changes occurring during high thermal load and synthesis of electrode materials for Li-Ion batteries](#)

s06-033

Ayoung Kim (Energy Engineering, Hanyang University, Seoul, Korea), Eunjun Park, Juhye Song, Hansu Kim

[Electrochemical Properties of Nanostructured MoO₂ Anode for Lithium Secondary Batteries](#)

s06-034

Duri Kim (Graduate School of Knowledge-based Technology and Energy, Korea Polytechnic University, Sangidaehak-ro 237, Siheung-si, Korea), Mina You, Min Young Hong, Ji Heon Ryu

[Unusual Voltage Profiles of Partially Discharged CoO Negative Electrode in Conversion Reaction](#)

s06-035

Hyeyun Kim (Department of Chemical Engineering and Technology, KTH Royal Institute of Technology, Stockholm, Sweden), Volodymyr Kuzmenko, Peter Enoksson, Huiran Lu, Ann Cornell

[Lithium Ion Battery Separator Based On Electrospun Cellulose Mats](#)

s06-036

Omer Ulas Kudu (Materials Science and Nanotechnology, National Nanotechnology Research Center (UNAM), Bilkent Univ, Ankara, Turkey), Cevriye Koz, Eda Yilmaz

[Silicon Nanoparticles & Carbon Nanofibers Composite Materials for Li-ion Battery Anodes](#)

s06-037

Abhishek Lahiri (Institute of Electrochemistry, Clausthal University of Technology, Clausthal Zellerfeld, Germany), Mark Olschewski, Frank Endres

[Investigation of \[Py_{1,4}\]TFSI/\[Py_{1,4}\]FSI Ionic Liquids Containing LiTFSI as electrolytes for lithium-ion battery](#)

s06-038

Michael Lammer (Chemical Engineering and Environmental Technology, Graz University of Technology, Graz, Austria), Alexander Koenigseder, Viktor Hacker

[Investigation into the thermal runaway of Li-ion batteries by gas analysis and temperature monitoring](#)

s06-039

Natalia Lebedeva (Institute for Energy and Transport (IET), European Commission, Joint Research Centre (JRC), Petten, Netherlands), Lois Boon-Brett

[Considerations on the chemical toxicity of contemporary Li-ion battery electrolytes and their components](#)

s06-040

Natalia Lebedeva (Institute for Energy and Transport (IET), European Commission, Joint Research Centre (JRC), Petten, Netherlands), Natalia Lebedeva, Franco Di Persio, Lois Boon-Brett

[Fostering EU competitiveness in the global battery sector to drive e-mobility forward](#)

s06-041

Ezequiel Pedro Marcos Leiva (Departamento de Matemática y Física, Universidad Nacional de Córdoba, Córdoba, Argentina), Manuel Otero, Laura Urquiza, Guillermina Luque, Daniel Barraco

[First-Principles studies of silicon underpotential deposition on defective graphene and its relevance for lithium-ion batteries](#)

s06-042

Ezequiel Pedro Marcos Leiva (Departamento de Matemática y Física, Universidad Nacional de Córdoba, Córdoba, Argentina), Manuel Otero, Laura Urquiza, Susana Chauque, Maximiliano Gavilán, Eduardo Perassi, Patricio Vélez, Oscar Oviedo, Osvaldo Cámara, Guillermina Luque, Fabiana Oliva, Daniel Barraco, Alejandro Franco

[Understanding Lithium Storage in Graphite and Silicon Materials through Computer Simulations](#)

s06-043

Xiaoxia Li (School of Chemistry and Environment, Beihang University, Beijing, China)

[Synthesis of Graphene-wrapped Cu₂O Mesoporous Spheres \(MPS\) Nanocomposites with Lithium Storage Properties](#)

s06-044

Yang Li (Chemical Engineering, National Taiwan University, Taipei, Taiwan), Nae-Lih Wu

[A Multifunctional Polymer-Blend Coating for Graphite Anode Enabled by Cross-Linking of Polymers with Specific Functional Groups for Li Ion Batteries](#)

s06-045

Qiyang Li (Faculty of Materials Science and Chemistry, China University of Geosciences Wuhan, Wuhan, China), Chenggang Zhou, Zhuan Ji, Bo Han, Liang Feng, Jinping Wu

[High-Performance Lithium/Sulfur Batteries by Decorating CMK-3/S with Fine-amount DNA](#)

- s06-046
Pierre Martin (Department of Chemistry, Deakin University, Geelong, Australia)
[Studies of motions and interactions of molecules in ionic liquid electrolytes by nuclear magnetic resonance](#)
- s06-047
Sebastian Mai (Electrochemistry and Electroplating Group, Technische Universität Ilmenau, Ilmenau, Germany), Svetlozar Ivanov, Andre Müller, Andreas Bund, Anna Dimitrova, Stefan Krischok
[Improving the Lithium-ion Battery Anode Interfacial Properties by Application of Diphenyl-Octyl-Phosphate](#)
- s06-048
Fabio Maroni (School Of Science And Technology - Chemistry Division, University of Camerino, Camerino, Italy), Serena Gabrielli, Alessandro Palmieri, Enrico Marcantoni, Fausto Croce, Francesco Nobili
[High cycling stability of Fe₃O₄ nanoparticles and Poly\(Acrylic Acid\) binder as anodes for Lithium-ion batteries.](#)
- s06-049
Omar S. Mendoza-Hernandez (Institute of Space and Astronautical Science, Japan Aerospace and Exploration Agency, Sagami-hara, Japan), Shuichi Taniguchi, Yuki Maruyama, Hiroaki Ishikawa, Yoshitsugu Sone, Minoru Umeda
[Accelerating Rate Calorimetry Tests of 18650 Li-ion Cells before and after Degradation](#)
- s06-050
Jadra Mosa (Institute of Ceramic and Glass, CSIC, Madrid, Spain), J.F. Vélez, Mario Aparicio
[Solid Hybrid organic-inorganic electrolytes by sol-gel for Li-ion battery applications](#)
- s06-051
Manuel Otero (Departamento de Matemática y Física, Universidad Nacional de Córdoba, Córdoba, Argentina), Fabián Vaca Chávez, María Cecilia Valentinuzzi, Ezequiel Pedro Marcos Leiva, Daniel Barraco, Susana Chauque, Fabiana Oliva, Gustavo Monti
[Structural and Morphological Characterization of Lithium Titanate: Application to Lithium Batteries](#)
- s06-052
Manuel Otero (Departamento de Matemática y Física, Universidad Nacional de Córdoba, Córdoba, Argentina), Sergio Ceppi, Carla Robledo, Guillermo Stutz, Daniel Barraco, Ezequiel Pedro Marcos Leiva
[Stage Analysis of Li-intercalated Graphite by Inelastic X-ray Scattering](#)
- s06-053
Seyma Ozcan (Metallurgy and Material Science, Sakarya University, Sakarya, Turkey)
[Graphene/MnO₂ Free Standing Paper Cathode Synthesis For High Reversible Lithium Ion Batteries](#)
- s06-054
Selda Ozkan (Department of Materials Science, WW4-LKO, University of Erlangen-Nuremberg, Erlangen, Germany), Gihoon Cha, Nhat Truong Nguyen, Anca Mazare, Patrik Schmuki
[Modified TiO₂ NTs for Battery Application](#)
- s06-055
Tobias Placke (MEET Battery Research Center, University of Münster, Münster, Germany), Paul Meister, Haiping Jia, Richard Klöpsch, Martin Winter
[Coulombic efficiency, voltage efficiency and energy efficiency of lithium-ion battery anode and cathode materials and their impact on practical application](#)
- s06-056
Antonia Reyes Jiménez (MEET Battery Research Center/Institute of Physical Chemistry, University of Münster, Münster, Germany), Martin Winter, Tobias Placke
[Application of Silicon-Carbon and Lithium Cobalt Oxide \(LCO\) Thin Films in Lithium-Ion Batteries](#)
- s06-057
James Rohan (Tyndall National Institute, University College Cork, Cork, Ireland), Tomás Clancy, Louise McGrath
[Nanoscale active materials for on-chip energy storage](#)

s06-058

Vanesa Ruiz (Energy Conversion and Storage Technologies Unit, Joint Research Centre, Institute for Energy and Transport, Petten, Netherlands), Akos Kriston, Matteo Destro, Daniela Fontana, Andreas Pfrang, Lois Boon-Brett

[Degradation Studies on Lithium Ion Batteries - The Effect of Dissimilar Charging – Discharging Temperatures](#)

s06-059

Yoji Sakurai (Electrical and Electronic Information Engineering, Toyohashi University of Technology, Toyohashi, Japan), Masahiro Utagawa, Takao Tsuda, Mizuki Kadowaki, Shinpei Yamaguchi, Tomohiro Tojo, Ryoji Inada

[Single Crystal Growth of Mn-Spinel and Its Electrochemical Characterization by the Current Collector Integrated Microelectrode](#)

s06-060

Bing-Yi Shih (Department of Chemical Engineering, National Taiwan University, Taipei, Taiwan), Nae-Lih Wu, Pei-Sian Shao

[Improving Performance of \$\text{LiNi}_x\text{Co}_y\text{Mn}_{1-x-y}\text{O}_2\$ Li-ion Battery Cathode with Polymer-Blend Coating](#)

s06-061

Jeongyim Shin (Energy and Materials Engineering, Dongguk University, Seoul, Korea), Junghoon Yang, Yong-Mook Kang

[\$\text{Li}_3\text{V}_2\(\text{PO}_4\)_3\$ Particles Anchored in Carbon Nanofiber as a Cathode Material for High-power Lithium Rechargeable Battery](#)

s06-062

Florian Sigel (Institute for Applied Materials - Energy Storage Systems, Karlsruhe Institute of Technology (KIT), Eggenstein-Leopoldshafen, Germany), Björn Schwarz, Sylvio Indris, Helmut Ehrenberg

[Investigation of degradation behavior in Li- and Mn-rich NCM cathode materials with high-resolution solid state NMR spectroscopy](#)

s06-063

Alexander Skundin (Processes in Batteries, 31, Leninskii Prospekt, Moscow, Russia), Tatiana Kulova, Sergey Sigalaev, Alexander Mironenko

[Layered Silicon Composite Electrodes for Lithium-ion Batteries: the Initial Stage of Cycling](#)

s06-064

Miriam Steinhauer (Institute for Engineering Thermodynamics, German Aerospace Center, Stuttgart, Germany)

[How Thick is the Solid Electrolyte Interphase in Lithium-Ion Batteries?](#)

s06-065

Vasily Sumanov (Department of Chemistry, Lomonosov Moscow State University, Moscow, Russia), Oleg Drozhzhin, Felix Sharikov, Andrey Baranov, Evgeny Antipov

[Hydro- and solvothermal synthesis of the mixed olivines \$\text{Li}\(\text{Fe,Mn,Co}\)\text{PO}_4\$ as cathode materials for Li-ion batteries](#)

s06-066

Kohei Tanaka (Space and Astronautical Science, Sokendai, Kanagawa-Pref., Japan), Yoshitsugu Sone, Omar S. Mendoza-Hernandez, Seisuke Fukuda, Masayuki Itagaki

[The AC Impedance Changing of the Olivine-type Lithium-Ion Secondary Cells through Charge/Discharge Cycling](#)

s06-067

Anthony Thomas (Engineering Science, Poitiers, France), Serguei Martemianov, Florian Maillard, Patrick Lagonotte, Ludovic Madier

[New methodology of electrochemical noise analysis and applications for commercial Li-ion batteries](#)

- s06-068
Mahmud Tokur (Metallurgical and Material Engineering, Sakarya University, Sakarya, Turkey)
[Graphene Wrapped Silicon/Carbon Composite Anodes for High Reversible Lithium Ion Battery](#)
- s06-069
Ulderico Ulissi (Helmholtz Institute Ulm, Karlsruhe Institute of Technology, Ulm, Germany), Giuseppe Antonio Elia, Hassoun Jusef, Stefano Passerini
[Room Temperature Ionic liquid based electrolytes: case studies in high performance lithium ion battery configurations](#)
- s06-070
Maria Varini (Applied Electrochemistry, KTH Royal Institute of Technology, Stockholm, Sweden), Matilda Klett, Göran Lindbergh
[Temperature dependent behavior of \$\text{LiNi}_{1/3}\text{Co}_{1/3}\text{Mn}_{1/3}\text{O}_2\$ in Li-ion batteries](#)
- s06-071
Marnix Wagemaker (Applied Sciences, Delft University of Technology, Delft, Netherlands)
[Direct view on Li-ion transport in electrodes by operando Neutron Depth Profiling and following the phase transition in individual grains by operando Micro-beam diffraction](#)
- s06-072
Zhaohui Wang (Department of Chemistry-The Angström Laboratory, Uppsala University, Uppsala, Sweden), Chao Xu, Petter Tammela, Maria Strømme, Kristina Edström, Torbjörn Gustafsson, Leif Nyholm
[Paper-Based Flexible Si anodes for Lithium-Ion Batteries](#)
- s06-073
Li Wang (College of Chemistry and Chemical Engineering, Jiangxi Normal University, Nanchang, China), Yaqin Chen, Yonghai Song
[Zn/Fe-MOFs-derived hollow ball-in-ball \$\text{ZnO}/\text{ZnFe}_2\text{O}_4\$ @carbon nanospheres with exceptional lithium storage performance](#)
- s06-074
Gunther Wittstock (Institute of Chemistry, Carl von Ossietzky University of Oldenburg, Oldenburg, Germany), Heinz Bültel, Fabian Peters
[In situ comparison of solid electrolyte interphases at HOPG, Li metal and graphite composite electrodes](#)
- s06-075
Rakel Wreland Lindström (Chemical Engineering and Technology, KTH Royal Institute of Technology, Stockholm, Sweden), Matilda Klett, Pontus Svens, Carl Tengstedt, Antoine Seyeux, Jolanta Swiatowska, Göran Lindbergh
[Uneven SEI Growth Across Depth in Aged Li-Ion Battery Graphite Electrodes](#)
- s06-076
Anjian Xie (School of Chemistry and Chemical Engineering, Anhui University, Hefei, China), Juan Dai, Yuhua Shen
[Synthesis and Electrochemical Performance of \$\text{Co}_3\text{O}_4\$ /CNT Nanocomposite as the Anode for Lithium-ion Batteries](#)
- s06-077
Rongbin Ye (Faculty of Science and Engineering, Iwate University, Morioka, Japan), Keidai Sasaki, Koji Ohta, Mamoru Baba
[Fabrication and characterization of \$\text{LiCoO}_2\$ thin films for flexible thin film lithium ion batteries](#)
- s06-078
Xinhua Zhu (SURF Research Group, Department Materials and Chemistry, Vrije Universiteit Brussels, Brussels, Belgium), Lucia Fernandez Macia, Noshin Omar, Annick Hubin
[Aging Study of Commercial \$\text{Li}_4\text{Ti}_5\text{O}_{12}/\text{Li}\(\text{NiCoAl}\)\text{O}_2\$ Lithium Ion Batteries](#)
- s06-079
Jianli Zou (Stephenson Institute for Renewable Energy, The University of Liverpool, Liverpool, United Kingdom), Christopher Sole, Nicholas Drewett
[In situ Observation of Li Intercalation into Graphitic Flakes of Varying Layer Number](#)

s06-080

Eduardo dos Santos Sardinha (Institute of Chemistry, Carl von Ossietzky Universität Oldenburg, Oldenburg, Germany), Markus Ding, Stefano Passerini, Gunther Wittstock

[SECM Investigation of Solid Electrolyte Interfaces on Freshly Prepared Li Metal Surfaces](#)

s06-081

Eduardo dos Santos Sardinha (Institute of Chemistry, Carl von Ossietzky Universität Oldenburg, Oldenburg, Germany), Heinz Bültner, Gunther Wittstock

[Passive layers on Si Negative Electrodes Investigated by Scanning Electrochemical Microscopy and X-ray Photoelectron Spectroscopy](#)

s06-082

Evert Jonathan van den Ham (Inorganic and Physical Chemistry, Hasselt University, Hasselt, Belgium), Sven Gielis, Gilles Bonneux, Wouter Marchal, Felix Mattelaer, Christophe Detavernier, Marlies Van Bael, An Hardy

[WO₃ deposition via ultrasonic spray deposition on high-aspect ratio TiN coated Si micro pillars for all-solid-state 3D Li-ion batteries](#)

Metal-air

s06-083

Andrew Basile (Institute for Frontier Materials, Deakin University, Melbourne, Australia), Maria Forsyth, Patrick Howlett, Douglas MacFarlane, Cameron Pope, Hyungook Yoon

[Enabling Sodium metal anodes using concentrated salt in ionic liquid electrolytes](#)

s06-084

Kivanc Coban (Material Science and Nanotechnology, Bilkent University - National Nanotechnology Research Center, Ankara, Turkey), Eda Yilmaz

[Investigation of Molybdenum Oxides as Catalyst Material for Non-Aqueous Li-O₂ Batteries](#)

s06-085

Horacio Antonio Figueredo-Rodríguez (Energy Research Group, University of Southampton, Southampton, United Kingdom), Rachel McKerracher, Carlos Ponce de Leon

[Cell design and characterization of an iron-air battery \(IAB\)](#)

s06-086

Yuyang Hou (Intelligent Polymer Research Institute, University of Wollongong, Wollongong, Australia), Jiazhao Wang, Huakun Liu, Jun Chen

[The Effect of Catalyst Distribution on Cycling Performance of Li-O₂ Batteries](#)

s06-087

Dong-Wan Kim (School of Civil, Environmental and Architectural Engineering, Korea University, Seoul, Korea), Gwang-Hee Lee, Seun Lee, Changhoon Choi, Joosun Kim, Hae-June Je, Byung-Kook Kim

[Graphene Electrocatalysts for High Capacity Lithium-Air Batteries](#)

s06-088

Ryo Kobayashi (Department of Frontier Materials and Function Engineering, Iwate University, Morioka, Iwate, Japan), Tatsuya Takeguchi, Yoshihiro Kadoma, Koichi Ui

[Effect of Porous Structures on ORR Activity of the Perovskite-type Oxide Catalyst having Gas Flow Channels and Macropores](#)

s06-089

Alexander Kube (TT-ECE, German Aerospace Center, Stuttgart, Germany), Dennis Wittmaier, Norbert Wagner

[Production and characterization of bi-functional cathodes for secondary zinc-air batteries](#)

s06-090

Jun Maruyama (Environmental Technology Research Division, Osaka Municipal Technical Research Institute, Osaka, Japan), Takahiro Hasegawa, Satoshi Iwasaki, Tomoko Fukuhara, Kohei Miyazaki

[Metal-Oxide-Loaded Carbonaceous Catalyst for Oxygen Reduction and Evolution](#)

s06-091

Danea Medina (Analytical Chemistry – Center for Electrochemical, Ruhr-Universität Bochum, Bochum, Germany), Edgar Ventosa, Dulce Maria Morales Hernandez, Nikola Markovic, Justus Masa, Wolfgang Schuhmann

[Evaluation of Electrocatalysts for Rechargeable Zinc-Air Batteries](#)

s06-092

Faruk Okur (Materials Science and Nanotechnology, Bilkent University, UNAM, Ankara, Turkey), Eda Yilmaz, Hamit Eren, Necmi Biyikli

[Thin TiO₂ Protective Layers on Multiwalled Carbon Nanotubes for Stable Li-O₂ Battery Cathodes](#)

s06-093

Mihui Park (Energy and Materials Engineering, Dongguk University, Seoul, Korea), Kyeongse Song, Yong-Mook Kang

[Catalytic Activity Variation with the Crystal Structure Change of PdCu Nanocatalysts for Rechargeable Lithium-Oxygen Batteries](#)

s06-094

Mehmet Can Yagci (Materials Science and Nanotechnology, Bilkent Univ.- National Nanotechnology Research Center(UNAM), Ankara, Turkey), Bhushan Patil, Eda Yilmaz

[Electrocatalytic Activity of Metal Oxide Nanocatalysts for Li-Air and Na-Air Batteries](#)

s06-095

Shen Ye (Institute for Catalysis, Hokkaido University, Sapporo, Japan), Qiao Yu, Can Liu

[Oxygen Reduction Reaction in Nonaqueous Solution for Li-O₂ Battery](#)

Na-ion

s06-096

Andrey Chekannikov (Frumkin Institute of Physical Chemistry and Electrochemistry, Moscow, Russia), Roman Kapaev, Svetlana Novikova, Tatiana Kulova, Alexander Skundin, Andrey Yaroslavtsev

[Positive electrode materials for Sodium-ion batteries](#)

s06-097

Xinwei Dou (Physical Chemistry, Karlsruhe Institute of Technology, Ulm, Germany), Daniel Buchholz, Christoph Vaalma, Stefano Passerini

[Biomass Waste Derived Hard Carbon Materials for SIBs](#)

s06-098

Burcu Dursun (Material Science and Engineering, Gebze Technical University, Kocaeli, Turkey), Taner Sar, Meltem Yesilcimen-Akbas, Rezan Demir-Cakan

[SnO₂@Pyrolyzed Bacterial Cellulose Composites as High Capacity Anode Materials for Na-ion Batteries](#)

s06-099

Burcu Dursun (Material Science and Engineering, Gebze Technical University, Kocaeli, Turkey), Rezan Demir-Cakan

[SnSb@Carbon Composites as Anode Materials for Na-ion Batteries](#)

s06-100

Argyrios Karatrantos (Chemical Engineering, University of Surrey, Guildford, United Kingdom), Qiong Cai

[Design of Nanoporous Carbons as Anode Materials for Sodium \(Na\) Ion Batteries](#)

s06-101

Shinichi Kumakura (Department of Applied Chemistry, Tokyo University of Science, Tokyo, Japan), Yoshiyuki Tahara, Kei Kubota, Shinichi Komaba

[Structural evolution of P2-type Na_{2/3}MnO₂ polymorphs by Na extraction/insertion](#)

s06-102

Mi-Sook Kwon (School of Chemical and Biological Engineering, Seoul National University, Seoul, Korea)[Layered Manganese Oxide Cathode Materials for Na-ion Batteries](#)

s06-103

Jesus Santos Pena (Lab PCM2E/ LRC, University of Tours, Tours, France), Barthelemy Aspe, Cecile Autret, Christine Damas, Benedicte Montigny[Analyzing the Effect of Hard Carbon Particle Size and Electrode Conductivity on Performances in Sodium Half Cells](#)

s06-104

Alexander Skundin (Processes in Batteries, 31, Leninskii Prospekt, Moscow, Russia), Tatiana Kulova, Andrey Chekannikov, Irina Stenina, Andrey Yaroslavtsev, A. Sobolev[Sodium Titanate as Material for Negative Electrode of Sodium-ion Batteries](#)

s06-105

Juhye Song (Energy Engineering, Hanyang University, Seoul, Korea), Goojin Jeong, Ah-Jung Lee, Jong Hwan Park, Ayoung Kim, Young-Jun Kim, Hansu Kim[Sodium Metal Interphase with Dendrite-Free Polygonal Structure in NaAlCl₄·2SO₂ Ionic Liquid for Room-Temperature Sodium Rechargeable Battery.](#)

s06-106

Ivan Tereshchenko (Department of Chemistry, Lomonosov Moscow State University, Moscow, Russia), Gregory Skorupsky, Oleg Drozhzhin, Evgeny Antipov[Hydro- and solvothermal synthesis of Na₂FePO₄F as cathode materials for lithium- and sodium-ion batteries](#)

s06-107

Yaolin Xu (Chemical Engineering, Delft University of Technology, Delft, Netherlands), Ellie Swaans, Dana M. Borsa, Fokko M. Mulder[Reversible Na-Ion Uptake in Si Nanoparticles](#)

Post Li-ion technologies

s06-108

A.A. Abd-El-Latif (Institute of Physical and Theoretical Chemistry, University of Bonn, Bonn, Germany), Philip Hegemann, Lingxing Zan, Martina Hegemann, Helmut Baltruschat[Stability and Cyclebility of Magnesium Deposition/Dissolution Reactions and its Application as a Secondary Battery](#)

s06-109

Chunguang Chen (Department of Electrical Engineering, Eindhoven University of Technology, Eindhoven, Netherlands), Jie Xie, Ruediger-A. Eichel, P.H.L. Notten[Deposition and electrochemical characterization of Ta₂O₅ thin film electrodes for 3D-integrated all-solid-state Lithium-ion batteries](#)

s06-110

Kuniko Chihara (Department of Applied Chemistry, Tokyo University of Science, Tokyo, Japan), Akihiro Katogi, Kei Kubota, Shinichi Komaba[KTi₂\(PO₄\)₃: electrochemical potassiation and sodiation](#)

s06-111

Sangwon Choi (Dept. of Chemical Engineering, Inha University, Incheon, Korea), Hyungho Go, Gibaek Lee, Yongsug Tak[Effects of Ionic Liquid Electrolyte Compositions on the Stability of Aluminum Anode in Al-ion battery](#)

s06-112

Markus Ding (Physical Chemistry, Karlsruher Institute of Technology, Helmholtz Institute Ulm, Ulm, Germany), Stephan Koch, Stefano Passerini[Artificial Solid Electrolyte Interphase on Lithium Metal Surfaces](#)

s06-113

Minato Egashira (College of Bioresource Sciences, Nihon University, Fujisawa, Japan), Kaori Hiratsuka, Kouki Matsubara, Keitaro Sodeyama, Yoshitaka Tateyama, Yasuhiro Akita, Kiyoshi Kanamura

[Magnesium Deposition in Non-aqueous Electrolytes Containing Multi-dentate Magnesium Halide Complex](#)

s06-114

K. Andreas Friedrich (Electrochemical Energy Technology, German Aerospace Center (DLR), Stuttgart, Germany), Natalia A. Cañas, Sebastian Risse, Sijie Zhao, Norbert Wagner, Matthias Ballauff

[Investigations of Lithium-Sulfur Batteries at Low and Elevated Temperatures](#)

s06-115

Chaopeng Fu (College of Chemistry and Chemical Engineering, Hunan University, Changsha, China), Yi Gong, Liang Chen, Yafei Kuang

[Synthesis of Chemically Bonded Sulfur/Curly Graphene Nanoribbon Composite for High-Performance Lithium-Sulfur Batteries](#)

s06-116

Nuria Garcia-Araez (Chemistry, University of Southampton, Southampton, United Kingdom), James Dibden, John Smith, Nan Zhou, John Owen

[A Quantitative Tool to Predict the Phase Composition of Lithium-Sulfur Batteries](#)

s06-117

Ping He (College of Engineering and Applied Sciences, Nanjing University, Nanjing, China)

[Ru functionalized graphene aerogels with hierarchical and three-dimensional porosity as a freestanding cathode for rechargeable Li-O₂ batteries](#)

s06-118

Andreas Heckmann (MEET Battery Research Center, University of Muenster, Muenster, Germany), Martin Winter, Tobias Placke

[How does the Structure of Graphitic Carbon Influence the Intercalation of Anions?](#)

s06-119

Seung-Tae Hong (Energy Systems Engineering, DGIST, Daegu, Korea), Munseok Chae, Jongwook Heo, Sung-Chul Lim

[Electrochemical Zinc Ion Intercalation Chemistry and Crystal Structures of Zinc Chevrel Phase and Rhombohedral Zinc Hexacyanoferrate for Post Li-Ion battery](#)

s06-120

Kim JinWon (Center for Chemical Energy Storage System, Gwangju Institute of Science and Technology, Gwangju, Korea), Jeon Haesong

[Effect of electrochemical behavior on lithium sulfur battery following carbon host structure](#)

s06-121

Hyun Soo Kim (Battery Research Center, KERI, Changwon, Korea), Seon-Min Kim, Sang-Min Lee

[Cell Design of a Planer-Type Sodium-Nickel Chloride Battery](#)

s06-122

Dong-Min Kim (School of Chemical and Biological Engineering, Seoul National University, Seoul, Korea)

[Natural graphite as an anode for Mg-ion batteries](#)

s06-123

Yong-Gun Lee (Energy Lab., Materials R&D Center, Samsung Advanced Institute of Technology, Samsung Electronics, Suwon, Korea), Saebom Ryu, Toshinori Sugimoto, Won-seok Chang, Hong Soo Choi

[High Energy Density Li Metal Battery Anode Protected by Multifunctional Block Copolymer Composite Thin Films](#)

s06-124

Jessica Lueck (German Aerospace Center (DLR), Helmholtz Institute Ulm (HIU), Ulm, Germany), Timo Danner, Arnulf Latz

[Electrosorption in lithium-sulfur batteries: modeling of solvation and adsorption at nanostructured cathodes](#)

s06-125

Martin Mayo (Department of Physics, University of Cambridge, Cambridge, United Kingdom), Kent Griffith, Chris Pickard, Clare Grey, Andrew Morris

[Phosphorus Electrodes for Li and Na-Ion Batteries: from high-throughput screening and AIRSS](#)

s06-126

Rachel McKerracher (Engineering & the Environment, University of Southampton, Southampton, United Kingdom), Alex Holland, Richard Wills

[Development of Novel Intercalation Materials for an Aluminium-Ion Battery](#)

s06-127

Chanbum Park (Institut für Physik, Humboldt-Universität zu Berlin, Berlin, Germany), Joachim Dzubiella

[Molecular Modeling Studies of lithium bis\(fluorosulfonyl\)imide/1,2-dimethoxyethane and 1,3-dioxolane](#)

s06-128

Paulina Polrolniczak (Department of Advanced Materials and Analytics, Institute of Non-Ferrous Metals Division in Poznan, Poznan, Poland), Krzysztof Wasinski, Mariusz Walkowiak, Piotr Nowicki, Robert Pietrzak

[Carbon from waste materials as cathode component for high energy Li-S batteries](#)

s06-129

Norbert Weber (Institute of Fluid Dynamics, Helmholtz-Zentrum Dresden - Rossendorf, Dresden, Germany), Wietze Herreman, Steffen Landgraf, Caroline Nore, Frank Stefani, Tom Weier

[Liquid metal batteries: Numerical simulations](#)

s06-130

Tom Weier (Institute of Fluid Dynamics, Helmholtz-Zentrum Dresden - Rossendorf, Dresden, Germany), Steffen Landgraf, Marco Starace, Frank Stefani, Norbert Weber

[Visual observations and charge/discharge behavior of liquid metal cells](#)

Solid electrolytes

s06-131

Katharina Becker-Steinberger (Computational Electrochemistry, Helmholtz Institute Ulm for Electrochemical Energy Storage, Ulm, Germany), Stefanie Braun, Simon Schardt, Arnulf Latz

[The Influence of Interface Modifications to Space Charge Layer Formation in Solid Electrolytes](#)

s06-132

Candace Chan (Materials Science and Engineering, Arizona State University, Tempe, USA), Ting Yang, Zachary Gordon

[Synthesis and Characterization of Nanostructured \$\text{Li}_7\text{La}_3\text{Zr}_2\text{O}_{12}\$ Solid Electrolytes using Electrospinning and Nanocellulose Templating](#)

s06-133

Kiyoul Kim (4th R&D Institute, Agency for Defense Development, Daejeon, Korea), Yusong Choi

[The effects on electrochemical reaction mechanism of pyrite \(\$\text{FeS}_2\$ \) particle size for thermal batteries](#)

s06-134

Yingjia Liu (Dalian Institute of Chemical Physics, Chinese Academy of Sciences, Dalian, China), Jian Chen

[Synthesis of Lithium Aluminum Germanium Phosphate Electrolyte and its Compatibility with Cathode Materials for All-solid-state Lithium-ion Battery](#)

s06-135

Yingjia Liu (Dalian Institute of Chemical Physics, Chinese Academy of Sciences, Dalian, China), Jian Chen

[Lithium Conducting Hybrid Solid Electrolyte and its All-solid-state Lithium Secondary Battery](#)

s06-136

Marco Schleutker (IEK-3, Forschungszentrum Jülich GmbH, Jülich, Germany), Carsten Korte, Detlef Stolten

[The Butler-Volmer-Like Behavior of the Interfacial Charge Transfer between Solid and Liquid \$\text{Li}^+\$ -Electrolytes](#)

- s06-137
Lyubov Shmygleva (Department of Functional Inorganic Materials, IPCP RAS, Chernogolovka, Russia)
[A Study of Transport of Alkaline Earth Metal Cations in the Polymer Electrolyte Based on Nafion](#)
- s06-138
Lyubov Shmygleva (Department of Functional Inorganic Materials, IPCP RAS, Chernogolovka, Russia)
[Acid Salts of Calix\(4\)arene Sulfonic Acid as New Class of 2D-proton Conductors with Stable Structure](#)
- s06-139
Chuang Yu (Reactor Institute Delft, Delft University of Technology, Mekelweg 15, Delft, Netherlands), Swapna Ganapathy, Niek Klerk, Ernst Eck, Marnix Wagemaker
[Improving Li-ion Dynamics in the cubic Garnet lithium ion conductor by Nb-doping](#)
- s06-140
Chuang Yu (Reactor Institute Delft, Delft University of Technology, Mekelweg 15, Delft, Netherlands)
[Li dynamics in the \$\text{Li}_6\text{PS}_5\text{Br}\$ solid electrolyte studied by \$^7\text{Li}\$ NMR and DFT Based Molecular Dynamics Simulations and its solid-state batteries applications](#)
- s06-141
Masahiro Toyoda (Applied Chemistry, Faculty of Engineering, Oita University, Oita, Japan), Yuuki Kanayama, Masatoshi Anai, Maki Hamaguchi, Toshinori Inoue, Taro Kinumoto, Tomoki Tsumura
[High-Performance EDLC using Carbon Electrode Prepared from Electrospinning](#)

Symposium 7 Novel Materials and Devices for Energy Conversion and Storage: Fuel Cells, Electrolysers, Regenerative Fuel Cells and Flow Batteries

(Electro)catalysis

- s07-001
Bernard John Tongol (Chemistry, University of Santo Tomas, Manila, Philippines), Maria Krisandra Mendoza, Sangaraju Shanmugam, Hasuck Kim
[Electrochemical and Surface Characteristics of PtSn/PEDOT/EGO as Anode Material for Direct Ethanol Fuel Cell Application](#)

Alkaline and PEM Water Electrolysis

- s07-002
Majid Asnavandi (Science, UNSW, Sydney, Australia), Chuan Zhao
[Create Defects: a Facile Approach to Enhance Ni-Fe Catalysts Performance for Oxygen Evolution Reaction](#)
- s07-003
Corina Andronescu (Analytical Chemistry, Center for Electrochemical Science, Ruhr-Universität Bochum, Bochum, Germany), Stefan Barwe, Justus Masa, Edgar Ventosa, Stefan Klink, Aziz Genç, Jordi Arbiol, Wolfgang Schuhmann
[MnxCoyOz Nanocubes Embedded in a Polybenzoxazine-derived Nitrogen-Doped Graphite-type Carbon Matrix as New Catalyst for the Oxygen Evolution Reaction](#)
- s07-004
Maryam Bayati (CEAM, Newcastle University, Newcastle, United Kingdom), Keith Scott
[Nanostructured Mn Inserted N-doped Graphene a Novel Catalyst for Hydrogen Reduction Reaction](#)
- s07-005
Iveta Boshnakova (PEM Hydrogen Systems, Institute of Electrochemistry and Energy Systems, Sofia, Bulgaria), Elefteria Lefterova, Evelina Slavcheva
[Montmorillonite - Supported Composite Catalysts For Water Electrolysis Cells](#)

s07-006

Cornelia Broicher (Institute for Technical and Macromolecular Chemistry, RWTH Aachen University, Aachen, Germany), Jens Artz, Peter Hausoul, Stefan Palkovits, Regina Palkovits

[Phtalocyanine based materials for electrochemical water oxidation](#)

s07-007

Janusz Flis (Department of Electrochemistry, Corrosion and Applied Surfac, Institute of Physical Chemistry PAS, Warsaw, Poland), Iwona Flis-Kabulska

[Activity of Ni-Fe Cathodes toward Alkaline Water Electrolysis and Effect of Anodic Oxidation](#)

s07-008

Iwona Flis-Kabulska (Department of Electrode Processes, Institute of Physical Chemistry PAS, Warsaw, Poland), Janusz Flis, Yong Sun, Arkadiusz Gajek, Magdalena Jaskolska, Tadeusz Zakroczymski

[Plasma Carburising for Improvement of Ni-Fe Cathodes for Alkaline Water Electrolysis](#)

s07-009

Yasuhiro Fukunaka (Nanotechnology Research Center, Waseda University, Tokyo, Japan), Wataru Majima, Hisayoshi Matsushima, Takayuki Homma

[Three-Phase Interfacial Phenomena in Alkaline Fuel Cell/Water Electrolysis](#)

s07-010

Fabrizio Ganci (Dipartimento di Ingegneria Chimica Gestionale Informatica e, Università di Palermo, Palermo, Italy), Rosalinda Inguanta, Salvatore Piazza, Carmelo Sunseri, Salvatore Lombardo

[Fabrication of Nanostructured Ni and Ni-Pd electrodes for water-alkaline electrolyzer](#)

s07-011

Fabrizio Ganci (Dipartimento di Ingegneria Chimica Gestionale Informatica e, Università di Palermo, Palermo, Italy), Rosalinda Inguanta, Salvatore Piazza, Carmelo Sunseri, Salvatore Lombardo

[Fabrication of Nanostructured Ni and Ni-IrO₂ electrodes for water-alkaline electrolyzer](#)

s07-012

Lu Gao (Chemical Engineering and Chemistry, Eindhoven University of Technology, Eindhoven, Netherlands), Jan P. Hofmann, Shi-Gang Sun, Emiel J.M. Hensen

[Enhancing the Hydrogen Evolution Reaction in Alkaline Solutions with High-Index Faceted Pt and Alloy Nanoparticles](#)

s07-013

Sina Hejazi (Department of Materials Science, WWIV-LKO, Friedrich-Alexander-Universität Erlangen-Nürnberg, Erlangen, Germany), Nhat Truong Nguyen, Anca Mazare, Patrik Schmuki

[Aminated TiO₂ nanotube as a Photoelectrochemical Water Splitting photoanode](#)

s07-014

Tanja Kallio (Department of Chemistry, Aalto University, Aalto, Finland), Fatemeh Davodi, Sami Tuomi, Maryam Borghei, Esko Kauppinen

[Nitrogen functionalizes carbon nanotubes as efficient electrocatalysts for energy conversion applications](#)

s07-015

Ferdi Karadas (Department of Chemistry, Bilkent University, Ankara, Turkey), Satya Vijaya Kumar Nune, Emine Ulker, Elif Pinar Alsac

[Cobalt-based Coordination Compounds as Heterogeneous Water Oxidation Catalysts](#)

s07-016

Soo-Kil Kim (School of Integrative Engineering, Chung-Ang University, Seoul, Korea), Ho Young Kim, Hyan Joo Park, Eunkyong Hwang, Sang Hyun Ahn

[Electrochemically Fabricated Non-precious Electrocatalysts for Acidic Hydrogen Evolution Reaction](#)

s07-017

Sang Ha Lee (School of Chemical Engineering, Sungkyunkwan University, Suwon, Korea), Soochan Kim, Won Bin Kim, Misuk Cho, Youngkwan Lee

[Layered Hollow Sphere Electrode Based on Iridium-Graphene for Oxygen Evolution Catalysis](#)

s07-018

Gerd Mutschke (Institute of Fluid Dynamics, Helmholtz-Zentrum Dresden - Rossendorf, Dresden, Germany), Jochen Fröhlich, Xuegeng Yang, Kerstin Eckert, Franziska Karnbach, Margitta Uhlemann, Dominik Baczymalski, Christian Cierpka

[Numerical simulation of mass transfer and convection near a hydrogen bubble during water electrolysis in a magnetic field](#)

s07-019

Sandra Möller (Analytical Chemistry, Ruhr-Universität Bochum, Bochum, Germany), Justus Masa, Helmut Baltruschat, Wolfgang Schuhmann

[Carbon Corrosion in Alkaline Media Studied by Means of Differential Electrochemical Mass Spectrometry](#)

s07-020

Boguslaw Pierozynski (Chemistry, University of Warmia and Mazury in Olsztyn, Olsztyn, Poland)

[Cathodic evolution of hydrogen on platinum-modified nickel foam catalyst](#)

s07-021

Martin Rabe (Interface Chemistry and Surface Engineering, Max-Planck-Institut für Eisenforschung GmbH, Düsseldorf, Germany), Adnan Sarfraz, Andreas Erbe

[Monitoring Oxide Layer Growth on Manganese Electrodes, by in-situ Spectroscopic Ellipsometry and Raman Spectroscopy](#)

s07-022

Maximilian Schalenbach (Department of Interface Chemistry and Surface Engineering, Max-Planck-Institut für Eisenforschung, Düsseldorf, Germany), Serhiy Cherevko, Marcelo Carmo, Wiebke Lueke, Detlef Stolten, Karl J.J. Mayrhofer

[Alkaline and Acidic Water Electrolysis: Characteristics and Efficiencies](#)

s07-023

Evelina Slavcheva (PEM Hydrogen Systems, Institute of Electrochemistry and Energy Systems, Sofia, Bulgaria)

[Magnelli Phase Supported Ni-Co Electrocatalysts for Anion Exchange Membrane Electrolysis Cells](#)

s07-024

Camillo Spoeeri (Department of Chemistry, Technical University of Berlin, Berlin, Germany), David P. Wilkinson, Peter Strasser

[Iridium-Based Mixed Metal Oxides for Electrochemical Water Splitting with Excellent Stability](#)

s07-025

Mohammad Tavakkoli (Department of Chemistry, School of Chemical Technology, Aalto University, Espoo, Finland), Tanja Kallio, Esko Kauppinen, Kari Laasonen

[Carbon nanotubes decorated with iron nanomaterials as active catalysts for electrochemical hydrogen production](#)

Flow Batteries

s07-026

Vinoth Ganesan (Department of Chemistry, Kongju National University, Kongju, Korea), Sivaprakasam Rathakrishnan

[A Novel Approach for the Synthesis of CuS@SiO₂ Hollow sphere Deposited with Ultrathin Polypyrrole \(PPy-CuS@SiO₂\) and their Superior electrocatalyst Towards Glucose and Methanol electro-oxidation](#)

s07-027

Anatoly Antipov (EMEE Laboratory, D. I. Mendeleev Russian University of Chemical Technology, Moscow, Russia), Mikhail Vorotyntsev

[Convection Effects on Bromate Electroreduction on Inactive RDE under Steady-State Conditions. Equal Diffusion Coefficients](#)

s07-028

Anatoly Antipov (EMEE Laboratory, D. I. Mendeleev Russian University of Chemical Technology, Moscow, Russia), Yury Tolmachev, Dmitry Konev, Alexander Modestov, Mikhail Vorotyntsev

[The First Practical Flow Battery for Stationary Energy Storage, Fully Electric Vehicles and Direct Solar-To-Chemical Energy Conversion](#)

s07-029

Craig Armstrong (Department of Chemistry, Lancaster University, Lancaster, United Kingdom), Kathryn Toghil

[The Development of New Chemistries as Redox Active Electrolytes for Non-Aqueous Redox-Flow Batteries](#)

s07-030

Ruiyong Chen (Joint Electrochemistry Lab, KIST Europe GmbH, Saarbruecken, Germany), Rolf Hempelmann

[Redox Flow Battery Using Aqueous Ionic Liquids as Electrolyte for High-Voltage Operation](#)

s07-031

Myounghoon Choun (School of Environmental Science and Engineering, Gwangju Institute of Science and Technology, Gwangju, Korea)

[Electro-oxidation of Mixed Reactants of Ethanol and Formate on Pd/C in Alkaline Fuel Cells](#)

s07-032

Alejandro N. Colli (Laboratoire d'Electrochimie Physique et Analytique (LEPA), École Polytechnique Fédérale de Lausanne (EPFL), Sion, Switzerland), Pekka Peljo, Hubert Girault

[Permanganate as a Positive Redox Couple of Alkaline Redox Flow Batteries](#)

s07-033

Igor Derr (Institute for Chemistry and Biochemistry, FU Berlin, Berlin, Germany), Christina Roth

[Degradation and countermeasures in all-Vanadium Redox Flow Batteries \(VRFB\)](#)

s07-034

Olga Istakova (Department of Technology of Polymer Composite Paint, D.I. Mendeleev University of Chemical Technology of Russia, Moscow, Russia), Anatoly Antipov, Mikhail Vorotyntsev

[Numerical Study of Transport Processes and Comproportionation Reaction in the Course of Bromate Electroreduction under Steady-State Conditions](#)

s07-035

Muthu Krishna (Faculty of Engineering & the Environment, University of Southampton, Southampton, United Kingdom), Richard Wills

[Developments in the Soluble Lead Flow Battery](#)

s07-036

María Isabel León Sotelo (Departamento de Química, Universidad de Guanajuato, Guanajuato, Mexico), José L. Nava, Silvia Gutierrez-Granados

[Numerical simulation of the hydrodynamics, mass transport, and current distribution in a redox flow battery Ce-V using carbon felt as electrodes](#)

s07-037

Petr Mazur (New Technologies - Research Centre, University of West Bohemia Pilsen, Pilsen, Czech Republic), Jaromir Pcedic, Jiri Vrana, Jan Dundalek, Juraj Kosek, Jindrich Mrlik, Vojtech Svoboda

[Optimization of graphite felt electrodes for redox flow batteries of various chemistries](#)

s07-038

Petr Mazur (New Technologies - Research Centre, University of West Bohemia Pilsen, Pilsen, Czech Republic), Jaromir Pcedic, Jiri Vrana, Jan Dundalek, Juraj Kosek, Milos Svoboda

[Electrochemical deposition of graphene oxide on graphite felts for vanadium redox flow battery](#)

s07-039

Julia Melke (Freiburger Materialforschungszentrum, Albert-Ludwigs-Universität Freiburg, Freiburg, Germany), Joachim Langner, Michael Bruns, Alexei Nefedov, Frieder Scheiba, Ditty Dixon, Christof Wöll, Helmut Ehrenberg, Christina Roth

[The Effect of Carbon Surface Properties on the Negative and Positive Half-Cell Reaction in all Vanadium Redox Flow Batteries](#)

s07-040

Birgit Pichler (Institute of Chemical Engineering & Environmental Technology, Graz University of Technology, Graz, Austria), Stephan Weinberger, Viktor Hacker

[Design of bifunctional air electrodes for Zn/air redox flow batteries](#)

s07-041

Jaromir Pecedic (New Technologies - Research Centre, University of West Bohemia, Pilsen, Czech Republic), Jan Dundalek, Jiri Vrana, Milan Solik, Milos Toulec, Petr Mazur, Juraj Kosek

[Experimental study and mathematical modeling of shunt currents in RFB stack](#)

s07-042

Joaquin Rodriguez Lopez (Department of Chemistry, University of Illinois at Urbana-Champaign, Urbana, USA), Elena Montoto, Shaoyi Qian, Nagarjuna Gavvalapalli, Kevin Cheng, Jarrod Milshtein, Teng-Sing Wei, Rylan Dmello, Vinay Iyer, Kyle Smith, Fikile Brushett, Jennifer Lewis, Jeffrey S. Moore

[Versatile Macromolecular Design for Emerging Size-Selective Non-Aqueous Redox Flow Batteries](#)

s07-043

Francesca Rubertelli (Process Technologies, Renewable Energy and Environmental R&D Center - eni SpA, Novara, Italy), Alessandra Tacca, Gabriella Tozzola, Fabio Oldani, Lino Carnelli

[The influence of different ligands on the electrochemistry of iron for redox flow battery application](#)

s07-044

Stefan Rümmler (Institut für Chemie, Martin-Luther-Universität Halle-Wittenberg, Halle, Germany), Dennis Przygodda, Mark Hartmann, Matthias Steimecke, Sabine Schimpf

[Functionalized carbon nanotubes as electrode material in all-vanadium redox-flow batteries](#)

s07-045

Waltraud Taucher-Mautner (Institute for Chemistry and Technology of Materials, Graz University of Technology, Graz, Austria), Elisabeth Domian

[Studies of the Spinel NiCo₂O₄ as Bifunctional Oxygen Catalyst for the Zinc/Air Redox Flow Battery](#)

s07-046

Yonggang Wang (Department of Chemistry, Fudan University, Shanghai, China), Xiaoli Dong, Long Chen

[Environmentally-friendly Aqueous Li \(or Na\)-ion Battery with Fast Electrode Kinetics and Super-long Life](#)

s07-047

Claudia Weidlich (Electrochemistry, DECHEMA-Forschungsinstitut, Frankfurt, Germany), Klaus-Michael Mangold, Philipp Pyka

[In situ SOC-monitoring at a VRFB test stand](#)

s07-048

Christian Zelger (Institute for Chemistry and Technology of Materials, Graz University of Technology, Graz, Austria), Jennifer Laumen, Andreas Laskos, Bernhard Gollas

[Rota-Hull Cell Study on Pulse Charging of Zinc/Air Redox Flow Batteries](#)

Fuel Cell

s07-049

Rasol Abdullah Mirzaie (Dept. of Chemistry, Shahid Rajae Teacher Training University, Tehran, Iran)

[Study of Using Chronoamperometry and Cyclic Voltammetry Techniques Together for Platinum Eleetrodepositor as an Electrocatalyst for Oxygen Reduction Reaction at Low Temperature Fuel Cell Systems](#)

s07-050

Rasol Abdullah Mirzaie (Dept. of Chemistry, Shahid Rajae Teacher Training University, Tehran, Iran)

[Study of Layer by Layer Electrodeposited Platinum–nickel Electrocatalyst as Anode for Glucose Biofuel Cell](#)

s07-051

Bincy George Abraham (Department of Chemical Engineering, Indian Institute of Technology Madras, Chennai, India), Raghuram Chetty

[Pt Electrodeposited on Optimized TiO₂ Nanotube Support for Methanol Oxidation in Direct Methanol Fuel Cell](#)

s07-052

Juan Carlos Abrego-Martínez (Sistemas Electroquímicos de Energía, CIDETEQ, Pedro Escobedo, Mexico), Youling Wang, Janet Ledesma-García, Gerardo Arriaga, Mohamed Mohamedi, Francisco Mherande Cuevas-Muñiz

[Ag/Pt/CP Prepared by PLD as Electrocatalyst for Oxygen Reduction in Methanol Presence](#)

s07-053

Juan Carlos Abrego-Martínez (Sistemas Electroquímicos de Energía, CIDETEQ, Pedro Escobedo, Mexico), Luis Humberto Mendoza-Huizar, Janet Ledesma-García, Gerardo Arriaga, Francisco Mherande Cuevas-Muñiz
[Electrochemical Deposition of a Methanol and Ethanol Tolerant PtAg Catalyst for ORR](#)

s07-054

Noé Arjona (Science and Technology, CIDETEQ, Tijuana, Mexico), Oscar Ambriz-Peláez, L. Alvarez-Contreras, M. Guerra-Balcázar, Janet Ledesma-García, Gerardo Arriaga
[Electrocatalytic Activity of Pd Nanocubes Nanocatalyst for the Ethylene Glycol Electrooxidation Reaction](#)

s07-055

Antony Cyril Arulrajan (Mesa+ Institute of Nanotechnology, University of Twente, Enschede, Netherlands), Stanley C.S. Lai
[Probing the role of mass transport in the electrocatalytic pathways](#)

s07-056

Sergey Belenov (Chemistry, Southern Federal University, Rostov-on-Don, Russia), Vasilij Pryadchenko, Vasilij Srabionyan, Leon Avakyan, Lusegen Bugaev, Natalya Tabachkova, Serezha Kirakosyan, Vadim Volochaev, Anastasia Alekseyenko, Vladimir Guterman
[Post-treatment of Pt-Cu/C electrocatalysts with uneven distribution of metals in nanoparticles – evolution of structure and activity](#)

s07-057

Sergey Belenov (Chemistry, Southern Federal University, Rostov-on-Don, Russia), Anastasia Alekseyenko, Yelizaveta Moguchikh, Irina Gerasimova, Vladimir Guterman, Vladislav Menshchikov, Vadim Volochaev, Natalya Tabachkova
[New approach to the synthesis of Pt/C catalysts for low temperature fuel cells](#)

s07-058

Mariem Belhadj (Syspol, LRGP-Univ-Lorraine-CNRS, Nancy, France)
[New European Driving Cycle for assessment of GDL durability in PEMFC's](#)

s07-059

Arno Bergmann (Department of Chemistry, Technische Universität Berlin, Berlin, Germany), Henrike Schmies, Stefanie Kühl, Jakub Drnec, Guanxiang Wang, Vijay K. Ramani, Peter Strasser
[An in situ XRD and SAXS Study of the Morphological Stability of Platinum Nanoparticles on Oxide Supports for Oxygen Reduction Reaction](#)

s07-060

Caroline Bonnet (Université de Lorraine, Laboratoire Réactions et Génie des Procédés, Nancy, France)
[GDL ex-situ and in-situ accelerated stress tests](#)

s07-061

Camila Canales (Química Inorgánica, Pontificia Universidad Católica de Chile, Santiago, Chile)
[Morphological and Raman characterization of electrodes modified with supramolecular assemblies of metalloporphyrins. Study towards dioxygen reduction reaction](#)

s07-062

Mitsuharu Chisaka (Graduate School of Science and Technology, Hirosaki University, Hirosaki, Japan), Noriaki Itagaki, Yusuke Yamamoto
[Active Site for Oxygen Reduction Reaction on Carbon-Support-Free Titanium Oxynitride Catalysts in Acidic Media](#)

s07-063

Chang Hyuck Choi (Department of Interface Chemistry and Surface Engineering, Max-Planck-Strasse 1, Düsseldorf, Germany), Karl J.J. Mayrhofer
[Degradation of Fe-N-C Catalysts Induced by Radical Oxygen Species](#)

s07-064

Myounghoon Choun (School of Environmental Science and Engineering, Gwangju Institute of Science and Technology, Gwangju, Korea)
[Formic acid/Formate Oxidation Behavior on Nobel Metal Catalyst](#)

s07-065

Adalgisa De Andrade (Chemistry Department, University of São Paulo- FFCLRP-USP, Ribeirão Preto, Brazil), Rodrigo Da Silva, Teko Napporn, Koaukou Boniface Kokoh

[Synthesis of Palladium-based Nanomaterials using Self-assembly Strategy for Direct Alcohols Oxidation in Alkaline Medium](#)

s07-066

Adeline Delvaux (Division of Materials and Process Engineering, Université Catholique de Louvain, Louvain-la-Neuve, Belgium)

[Improvement of Bubble Detachment and Overpotential during Hydrogen Evolution on De-alloyed Nickel electrodes](#)

s07-067

Monika Drakselová (Department of Inorganic Technology, University of Chemistry and Technology Prague, Prague, Czech Republic), Roman Kodym, Dalimil Snita, Karel Bouzek

[Local distributions of mass and charge in an industrial scale high temperature PEM fuel cell stack by 3D mathematical model](#)

s07-068

Victor Emets (Electrocatalysis, Frumkin Institute of Physical Chemistry and Electrochemistry, Moscow, Russia), Vitali Grinberg, Igor Ponomarev, Natalia Mayorova, Eugene Nizhnikovskiy

[Hydrogen-air fuel cells with polyheteroarylene-based membranes and commercial Nafion membrane](#)

s07-069

Lucia Fernandez Macia (Department of Materials and Chemistry, Vrije Universiteit Brussel, Brussels, Belgium), Dries Van Laethem, Thomas Collet, Johan Deconinck, Annick Hubin

[The Ionic Conductivity and Electrochemical Impedance of Acceptor Doped Ceria: an Experimental and Finite Element Modeling](#)

s07-071

Hiroshi Fukunaga (Materials and Chemical Engineering Course, Shinshu University, Ueda, Japan), Kanshi Kushibiki, Iori Shimada, Mitsumasa Osada, Nobuhide Takahashi

[Effect of Solvent to Microstructure of Metal-free Carbon Cathode Using Silk-derived Activated Carbon for PEFC](#)

s07-072

Hiroto Furukawa (Department of Materials Science and Technology, Nagaoka University of Technology, Nagaoka, Japan), Haruki Takada, Shoji Tanaka, Sayoko Shironita, Minoru Umeda

[Redox Properties of CO₂ at Pt-based Electrodes in H₂SO₄ Solution](#)

s07-073

Irã B.C. Gallo (Físico-Química, Instituto de Química, UNESP, Araraquara, Brazil), Emilia A. Carbonio, Hebe de las Mercedes Villullas

[Influence of Au Content on the Activity of PdAu Nanoalloys for Oxygen Reduction in Alkaline Medium](#)

s07-074

Armando Gennaro (Department of Chemical Sciences, University of Padova, Padova, Italy), Luca Picelli, Valentina Perazzolo, Roberto Pilot, Alessandro Martucci, Valerio Causin, Christian Durante

[Chemical and Electrochemical Properties of Mesoporous Carbon Nitride suitable for Oxygen Reduction Reaction](#)

s07-075

Keyla Godoi (Centro de Ciências Naturais e Humanas, Universidade Federal do ABC, Santo André, Brazil), Rejane Silva, Hugo Barbosa Suffredini

[Pt/C Catalyst for application in oil/water interface electrochemistry](#)

s07-076

Doris Grumelli (INIFTA, La Plata, Argentina), Santiago Herrera, Diana Hoetger, Eva Pensa, Klaus Kern, Rico Gutzler

[Improving the catalysis for O₂ reduction reaction mediated by Fe- phthalocyanine on Au\(111\): vapor deposition in ultra-high vacuum vs adsorption from solution](#)

s07-077

Byungchan Han (Chemical & Biomolecular Engineering, Yonsei University, Seoul, Korea), Jeemin Hwang, Seunghyo Noh

[Design of Highly Performing Catalysts Towards Oxygen Redox Reaction in Acidic and Alkaline Media with Non-precious Materials](#)

s07-078

Anayantzin Hernández (Energía, Cinvestav, Saltillo, Mexico), Francisco-Javier Rodriguez-Varela, Maria E. Sanchez-Castro

[Nanostructured Graphene Supported Pt-MTiO₃ \(M = Ni, Co\) Catalyst for the Oxygen Reduction Reaction in Alkaline Media](#)

s07-079

Jin-Song Hu (Key Laboratory of Molecular Nanostructure and Nanotechnology, Institute of Chemistry, Chinese Academy of Sciences, Beijing, China), Zidong Wei, Li-Jun Wan

[Highly Active Non-Precious Metal Nanocatalysts for Oxygen Reduction](#)

s07-080

Tsutomu Ioroi (Research Institute of Electrochemical Energy, AIST, Ikeda, Japan)

[Activity and Stability of Sub-Stoichiometric Titanium Oxide Supported Platinum-Transition Metal Alloy Catalyst for PEFCs](#)

s07-081

Akimitsu Ishihara (Institute of Advanced Sciences, Yokohama National University, Yokohama, Japan), Makoto Hamazaki, Yuko Tamura, Takaaki Nagai, Masashi Matsumoto, Hideto Imai, Koichi Matsuzawa, Shigenori Mitsushima, Ken-ichiro Ota

[Oxygen reduction activity of Nb doped TiO₂ single crystal model electrodes as non-platinum cathodes for PEFC](#)

s07-082

Primoz Jovanovic (Laboratory for Materials Chemistry, National Institute of Chemistry, Ljubljana, Slovenia), George Polymeros, Jan-Philipp Grote, Buddha Shrestha, Nejc Hodnik, Aleksandar Zeradjanin, Nadiia Kulyk, Karl J.J. Mayrhofer, Miran Gaberscek

[Floating Cell for Proton Exchange Membrane Fuel Cell and Electrolyser Catalyst Layer Investigation](#)

s07-083

Yu Kakizawa (Interdisciplinary Graduate School of Medicine and Engineerin, University of Yamanashi, Kofu, Japan), Kazuhiro Takanoashi, Masahiro Ihara, Yuzo Nagumo, Takashi Ohno, Adrien Lamibrac, Felix Buechi, Akihiro Iiyama

[Oxygen Partial Pressures inside Gas Diffusion Layer of Polymer Electrolyte Fuel Cell during Power Generation](#)

s07-084

Ilena Kaltenboeck (Institute of Chemical Engineering and Environmental Techn., Graz University of Technology, Graz, Austria), Bernd Cermenek, Christoph Grimmer, Viktor Hacker

[A passive, membrane-less and platinum-free direct ethanol fuel cell](#)

s07-085

Petri Kanninen (Department of Chemistry, Aalto University, Espoo, Finland), Nguyen Dang Luong, Le Hoang Sinh, Hua Jiang, Jukka Seppälä, Tanja Kallio

[Highly Active Platinum Nanoparticles Supported by Nitrogen/Sulfur Dual-Doped Graphene Composite for Ethanol Electro-Oxidation](#)

s07-086

Masaru Kato (Faculty of Environmental Earth Science, Hokkaido University, Sapporo, Japan), Marika Muto, Ichizo Yagi

[Non-Precious Metal Electrocatalysts with Multinuclear Copper Active Sites for the Oxygen Reduction Reaction](#)

s07-087

Alexander Keeler (School of Chemistry, University of Southampton, Southampton, United Kingdom), Andrea Russell

[Transferring the SERS effect from Au SSV substrates to Pt Nanoparticles](#)

s07-088

Seungjib Yum (Green Materials Research Group, Central Research Park, Kolon Industries, INC., Yongin-Si, Korea), Dong Hoon Lee, Eun-Su Lee, Nayoung Kim, Moo-Seok Lee

[Membrane Electrode Assembly for PEMFC using Reinforced Hydrocarbon-based Polymer Electrolyte Membrane](#)

s07-089

Bharathi Konkena (Analytical Chemistry, Center for Electrochemical Sciences, Ruhr-Universität, Bochum, Germany), Wolfgang Schuhmann, Justus Masa, Alexander J.R. Botz, Ilya Sinev, Wei Xia, Jörg Koßmann, Ralf Drautz, Martin Muhler

[Metallic Nickel Phosphorus Trisulfide Ultrathin Nanosheets as Highly Efficient and Stable Electrocatalyst for the Oxygen Evolution Reaction](#)

s07-090

Nadiia Kulyk (Department of Interface Chemistry and Surface Engineering, Max-Planck-Institut für Eisenforschung GmbH, Düsseldorf, Germany), Serhiy Cherevko, Karl J.J. Mayrhofer

[Transient Platinum Dissolution: Macro-Kinetic Simulation](#)

s07-091

Styven Lankiang (IC2MP - UMR CNRS 7285, University of Poitiers, Poitiers, France), Stève Baranton, Christophe Coutanceau

[Development of Ternary Catalysts for the Oxygen Reduction Reaction](#)

s07-092

Andreas Lesch (Laboratory of Physical and Analytical Electrochemistry, Ecole Polytechnique Federale de Lausanne, EPFL Valais Wallis, Sion, Switzerland), Victor Costa Bassetto, Hubert Girault

[Mass production of electrocatalysts and catalyst layers for energy conversion by inkjet printing](#)

s07-093

Xiao Lin (Department of Chemical Engineering and Biotechnology, University of Cambridge, Cambridge, United Kingdom), Tian Sheng, Zhaoyang Chen, P. Hu, Shi-Gang Sun, Y. Q. Chu, C. A. Ma, Wen-Feng Lin

[Tungsten Carbides Based Core-Shell Catalysts for Direct Methanol Fuel Cell Application](#)

s07-094

Jianguo Liu (College of Engineering and Applied Sciences, Nanjing University, Nanjing, China), Zhigang Zou, Congping Wu

[CeO₂ Doped FeN_x/C Catalyst with Enhanced Durability toward Oxygen Reduction Reaction](#)

s07-095

Chi-Yang Liu (Materials Science and Engineerin, National Cheng Kung University, Tainan, Taiwan), Shu-Yi Tsai, Chung-Ta Ni, Kuan-Zong Fung

[Influence of Phase Transformation on crystal structure and electrical properties of La_{0.7}Sr_{0.3}VO₃](#)

s07-096

Chi-Yang Liu (Materials Science and Engineering, National Cheng Kung University, Tainan, Taiwan), Shu-Yi Tsai, Chung-Ta Ni, Kuan-Zong Fung

[Influence of Sodium and Potassium ions doped strontium vanadate as anode materials for solid oxide fuel cell](#)

s07-097

Felix P. Lohmann (Chemical Department, Leibniz Institute of Surface Modification (IOM), Leipzig, Germany), Patricia Schulze, Olga Naumov, Maximilian Wagner, Bernd Abel, Aron Varga

[Facile, Scalable Synthesis of Platinum-CNT Composite Electrocatalyst for Solid Acid Fuel Cells](#)

s07-098

Yaxiang Lu (Department of Chemical and Process Engineering, University of Surrey, Guildford, United Kingdom), Qiong Cai, Kathrin Preuss, Maria-Magdalena Titirici

[Halloysite-Derived N-Doped Porous Carbon Nanosheets as Efficient Metal-Free Oxygen Reduction Electrocatalysts](#)

s07-099

Frédéric Maillard (LEPMI, CNRS, Saint Martin d'Hères, France), Laetitia Dubau[Unveiling the Crucial Role of Temperature on the Stability of Oxygen Reduction Reaction Electrocatalysts](#)

s07-100

Eftychia Martino (Chemical Engineering, University of Patras, Patras, Greece), Michalis Athanasiou, George Kiliyas, Alexandros Katsaounis, John Tsamopoulos, Constantinos Vayenas[Triode operation of fuel cells](#)

s07-101

J. Maya-Cornejo (Electrochemistry, Centro de Investigación y Desarrollo Tecnológico en Electro, Queretaro, Mexico), M. P. Gurrola, M. Guerra-Balcázar, F. J. Rodríguez-Valadez, Noé Arjona, Gerardo Arriaga[Green Use of Waste-Glycerol From Biodiesel Production As Fuel In A Microfluidic Fuel Cell](#)

s07-102

Jadra Mosa (Institute of Ceramic and Glass, CSIC, Madrid, Spain), P.G. Escribano, C. del Rio, E. Morales, Mario Aparicio[sSEBS/40SiO₂-40P₂O₅-20ZrO₂ Sol-Gel Composite Membranes for PEMFCs](#)

s07-103

Yoshihiro Mugikura (Energy Engineering Research Laboratory, Central Research Institute of Electric Power Industry, Yokosuka, Japan), Kenji Yasumoto, Hiroshi Morita, Tohru Yamamoto, Masahiro Yoshikawa[Degradation analysis of SOFC performance \(3\)](#)

s07-104

Yuta Nakai (Department of Frontier Materials and Function Engineering, Iwate University, Morioka, Japan), Tatsuya Takeguchi, Yoshihiro Kadoma, Koichi Ui[Influence of Pt Amounts on ORR Activities of Pt/C Catalysts for Low Pt Loading PEFCs](#)

s07-105

Abu Bakr Nassr (School of Chemistry, University of Southampton, Southampton, United Kingdom), Vinod Kumar Puthiyapura, Dan Brett, Christopher Hardacre, Andrea Russell[The effect of a hydrophobic barrier on butanol electrooxidation at Pt and PtSn electrocatalysts](#)

s07-106

Abu Bakr Nassr (Institute of Advanced Technology and New Materials, City for Scientific Research and Technology Applications, Alexandria, Egypt), Ahmed Al-Hakemy, Ahmed Naggar, Mohamed El-Nouby, Hesham Soliman, Mahmoud Taher[Electrodeposited mono and binary nanostructured transition metal oxides as electrocatalysts for oxygen reduction reaction](#)

s07-107

Stylios Neophytides (Institute of Chemical Engineering Sciences, Foundation for Research and Technology-Hellas, Patras, Greece), Eirini Zagoraïou, Nivedita Shrotri, Fotis Paloukis, Maria Daletou[In situ Evaluation of the Electrochemical Interface in High Temperature PEMFCs](#)

s07-108

Dimitris Niakolas (FORTH/ICE-HT, FORTH/ICE-HT, Patras, Greece), Charalampos Neofytidis, Stylios Neophytides[Carbon and Sulfur tolerant anodes for SOFCs](#)

s07-109

Jun Hwan Paik (Department of Chemical Engineering, Inha University, Incheon, Korea), Hyeonji Choi, Yongsug Tak[Preparation of Pt-Co Cathode of Polymer Electrolyte Membrane Fuel Cell Prepared by Sequential Electrodeposition Method](#)

s07-110

Valentina Perazzolo (Department of Chemical Science, University of Padova, Padova, Italy), Christian Durante, Gian Andrea Rizzi, Gaetano Granozzi, Armando Gennaro[Nitrogen and Sulphur Doped Mesoporous Carbon as Support for Platinum Nanoparticles](#)

s07-111

George Polymeros (Department of Interface Chemistry and Surface Engineering, Max-Planck-Institut für Eisenforschung GmbH, Düsseldorf, Germany), Claudio Baldizzone, Simon Geiger, Jan-Philipp Grote, Stefano Mezzavilla, Serhiy Cherevko, Aleksandar Zeradjanin, Karl J.J. Mayrhofer

[Improving the Electrocatalytic Stability of PEMFCs: High Temperature and Electrode Morphology Investigations](#)

s07-112

Vinod Kumar Puthiyapura (School of Chemistry and Chemical Engineering, Queen's University Belfast, Belfast, United Kingdom), Andrea Russell, Dan Brett, Wen-Feng Lin, Christopher Hardacre

[Sn modified Pt Bimetallic Catalyst for Butanol Oxidation Reaction](#)

s07-113

Maria Roca-Ayats (Structure and Reactivity, Institute of Catalysis and Petrochemistry. CSIC, Madrid, Spain), Enrico Pizzutilo, Simon Geiger, Gonzalo García, M^a Victoria Martínez-Huerta, Karl J.J. Mayrhofer

[On the Stability of Titanium Carbonitride Supported Platinum Catalysts under Electrochemical Conditions](#)

s07-114

Maria Roca-Ayats (Structure and Reactivity, Institute of Catalysis and Petrochemistry. CSIC, Madrid, Spain), Gonzalo García, Olmedo Guillén-Villafuerte, Miguel Soler-Vicedo, M^a Jesús Lázaro, Elena Pastor, M^a Victoria Martínez-Huerta

[Promotional Effect of a Titanium Carbonitride Support for the Ethanol Oxidation Reaction](#)

s07-115

Francisco-Javier Rodriguez-Varela (Nanoscience and Nanotechnology, Centro de Investigacion y de Estudios Avanzados del IPN, Ramos Arizpe, Mexico), Adriana Siller-Ceniceros, Maria E. Sanchez-Castro, Jose Torres-Lubian, Diana Morales-Acosta, Eduardo Martinez-Guerra

[Synthesis of novel Pt electrocatalysts supported on graphene functionalized with Ru-compounds \(Pt/G\) to enhance the catalytic activity for the Methanol Oxidation Reaction \(MOR\)](#)

s07-116

Anna Ryabova (icpees UMR 7515, University of Strasbourg, Strasbourg, France), Antoine Bonnefont, Galina Tsirlina, Elena Savinova

[Manganese Oxides for Electrocatalysis of the Oxygen and Hydrogen Peroxide Reactions](#)

s07-117

Monica Santamaria (Electrochemical Materials Science Laboratory, DICAM, University of Palermo, Palermo, Italy), Claudio Maria Pecoraro, Francesco Di Franco, Francesco Di Quarto

[Phosphomolybdic Acid and Mixed Phosphotungstic/Phosphomolybdic Acid Chitosan Membranes for H₂/O₂ Fuel Cells](#)

s07-118

Albert Serrà (Materials Science and Physical Chemistry, University of Barcelona, Barcelona, Spain), Elvira Gómez, Elisa Vallés

[Facile and Effective Electrochemical Synthesis of Mesoporous Co-based Nanorods Using Ionic Liquid Microemulsions with High Electrochemically Surface Areas and Enhanced Electrocatalytic Activity for Methanol Oxidation](#)

s07-119

Albert Serrà (Materials Science and Physical Chemistry, University of Barcelona, Barcelona, Spain), Joan Vilana, Elvira Gómez, Elisa Vallés

[Electrochemical Synthesis and Activation of Co_xNi_y Oxides as Electrocatalysts. Urea Electro-Oxidation](#)

s07-120

Ryo Shimizu (Interdisciplinary Graduate School of Medicine & Engineering, University of Yamanashi, Kofu, Japan), Yoko Sakiyama, Jun Takano, Shunsuke Itami, Masato Kusakabe, Kenji Miyatake, Akihiro Iiyama, Makoto Uchida

[Durability and Degradation Analysis of Novel Hydrocarbon Ionomer Membranes in PEFC Accelerated Stress Evaluation](#)

s07-121

Adriana Siller (Nanoscience and Nanotechnology, Centro de Investigacion y de Estudios Avanzados del Ipn, Saltillo, Mexico), Maria E. Sanchez-Castro, Jose Torres-Lubian, Diana Morales-Acosta, Eduardo Martinez-Guerra, Francisco-Javier Rodriguez-Varela

[Functionalization of Vulcan with Ru-compounds: novel Pt-Ru interactions to enhance the catalytic activity of Pt/C electrocatalyst for the Methanol Oxidation Reaction \(MOR\)](#)

s07-122

Olli Sorsa (Department of Chemistry, Aalto University, Espoo, Finland), Tanja Kallio, Davide Bergna, Ulla Lassi

[Co-electrodeposited Mesoporous PtM \(M=Co, Ni, Cu\) as an Active Catalyst for Oxygen Reduction Reaction in PEMFC](#)

s07-123

Eva-Maria Steyskal (Institute of Materials Physics, Graz University of Technology, Graz, Austria), Christopher Wiednig, Norbert Enzinger, Roland Würschum

[In-situ Characterization of Hydrogen Absorption in Nanoporous Palladium by Dilatometry and Resistometry](#)

s07-124

Dennis Sun (Catalyst Materials Research, Automotive Fuel Cell Cooperation, Burnaby, Canada), Jennie Eascott, Dorina Manolescu, Sharon Chen, Natalia Kremliakova

[Facile post-treatments for Improving carbon corrosion resistance of Pt/HSAC in proton exchange membrane fuel cells](#)

s07-125

Angel Tamariz (Facultad de Química, Universidad Nacional Autónoma de México, Ciudad de México, Mexico), Jorge Uribe-Godínez, Verónica García, Omar Jiménez-Sandoval

[MnRh-based and ReRh-based Materials Used as Electrocatalysts of the Hydrogen Oxidation and Oxygen Reduction Reactions](#)

s07-126

Yuko Tamura (Engineering, Yokohama National University, Yokohama, Japan), Akimitsu Ishihara, Takaaki Nagai, Koichi Matsuzawa, Shigenori Mitsushima, Ken-ichiro Ota

[Oxygen reduction activity of Nb added TiO₂ rod model electrodes as non-platinum cathodes for PEFC](#)

s07-127

Edson A. Ticianelli (Departamento de Fisico Quimica, Instituto de Quimica de Sao Carlos - USP, São Carlos, Brazil), Guilherme Gonçalves de Aquino Saglietti, Massimiliano Lo Faro, Antonino S. Aricò

[NiRu/CGO as catalytic pre-layer for SOFC anodes fed with carbon containing fuels](#)

s07-128

Aide M. Torres-Huerta (CIAMS, Instituto Politecnico Nacional, CICATA Unidad Altamira, Mexico, Mexico), Esther Ramírez-Meneses, Miguel A. Domínguez-Crespo, María G. Ponce-Varela, María A. Hernández-Pérez, I. Betancourt, E. Palacios-Gonzalez

[Synthesis and Electrochemical Characterization of Ni Nanoparticles by Hydrazine Reduction using Hydroxyethyl cellulose as Capping Agent](#)

s07-129

Simon A. Tschupp (Electrochemistry Laboratory, Paul Scherrer Institut, Villigen PSI, Switzerland), Sandra Elisabeth Temmel, Noemí Poyatos Salguero, Thomas Justus Schmidt

[An alternative system to the rotating disk: design, performance, and modelling](#)

s07-130

Sami Tuomi (Department of Chemistry, Aalto University, Espoo, Finland)

[Analysis of the hydrogen evolution reaction mechanism on Mo₂C nanoparticles by pH method](#)

s07-131

Jorge Uribe-Godínez (Inorganic Chemistry, Institute of Chemistry, UNAM, Mexico City, Mexico), Verónica García-Montalvo, Omar Jiménez-Sandoval

[Trimetallic-based Materials and their Performance as Electrocatalysts for the ORR and HOR](#)

s07-132

Hebe de las Mercedes Villullas (Físico-Química, Instituto de Química - UNESP, Araraquara - SP, Brazil), Gabriel M. Alvarenga, Elisete A. Batista, Irã B.C. Gallo

[Metal-Support Interactions and Catalytic Activity: Ethanol Oxidation on Pd Nanoparticles Supported on C-SnO₂/Sb₂O₅ Hybrids](#)

s07-133

Tao Wang (Chemistry Department, Xiamen University, Xiamen, China), Zhi-Xing Chen, Tian Sheng, Zhi-You Zhou, Hai-Ping Xia, Shi-Gang Sun

[Immobilizing Pyridine Derivative on Pt to Enhance H₂S and CO Tolerance For Hydrogen Oxidation](#)

s07-134

Pei Wang (Institut für Chemie, Martin-Luther-Universität Halle-Wittenberg, Halle, Germany), Katarzyna Kulp, Christian Kulp

[Synthesis of hierarchical CNT-CNT composites as catalyst support for application in electrocatalysis](#)

s07-135

Klaus Wippermann (IEK-3, Forschungszentrum Jülich, Jülich, Germany), Jürgen Wackerl, Susanne Kuhri, Carsten Korte, Werner Lehnert

[Influence of the Water Content in Proton Conducting Ionic Liquids on the Double Layer Capacitance and Oxygen Reduction Kinetics on Platinum](#)

s07-136

Chumeng Wu (Engineering, Yokohama National University, Yokohama, Japan), Akimitsu Ishihara, Takaaki Nagai, Koichi Matsuzawa, Shigenori Mitsushima, Ken-ichiro Ota

[Factors which affect oxygen reduction activities of titanium oxide-based compounds as non-platinum cathodes for PEFC](#)

s07-137

Zhaoxiong Xie (Department of Chemistry, Xiamen University, Xiamen, China), Qiaoli Chen, Yanyan Jia, Zhenming Cao

[Construction of Excavated Polyhedral Noble Metal Nanocrystals for Enhancing Electro-catalytic Performances](#)

s07-138

Robert Zacharias (Institute of Chemical Engineering and Environmental Techn., Graz University of Technology, Graz, Austria), Grimmer Christoph, Grandi Maximilian, Hacker Viktor

[A Mixed Electrolyte Approach for the Direct Borohydride Fuel Cell](#)

Regenerative Fuel Cells

s07-139

Ismail Abidat (Chemistry, IC2MP, Poitiers, France), Emmanuelle Cazayus, Claudia Morais, Clément Comminges, Teko Napporn, David Portehault, Olivier Durupthy, Aurélien Habrioux, Corinne Chanéac, Kouakou Boniface Kokoh

[Heteroatom-doped Graphene Supported Spinel Nanoparticles for the Elaboration of a Highly Active and Stable Reversible Air Electrode](#)

s07-140

Bapi Bera (Department of Energy Science and Engineering, Indian Institute of Technology Bombay, Mumbai, India)

[ORR, HER and OER in alkaline medium with cobalt supported on nitrogen-doped carbon](#)

s07-141

Déborah Chery (Chemistry, UPMC, Le Kremlin-Bicêtre, France)

[Thermodynamic and mechanistic approaches of CO₂ electrochemical reduction into CO in molten alkali carbonates](#)

s07-142

Christian Gutsche (Energy and Semiconductor Research Laboratory, University of Oldenburg, Oldenburg, Germany)

[Synthesis, Structure, and Electrochemical Stability of Ir-Decorated Pt Nanorods as Bifunctional Oxygen Reduction and Evolution Catalysts](#)

s07-143

Dulce Maria Morales Hernandez (Analytical Chemistry, Center for Electrochemical Sciences, Ruhr-Universität Bochum, Bochum, Germany), Justus Masa, Corina Andronescu, Yasin Ugur Kayran, Zhenyu Sun, Wolfgang Schuhmann

[Few Layer Graphene Modified with N4-Metallomacrocyclic Complexes as Bifunctional Catalyst for Reversible Oxygen Electrodes](#)

s07-144

Alexandr Oshchepkov (ICPEES UMR 7515, University of Strasbourg, Strasbourg, France), Antoine Bonnefont, Viktoriia Saveleva, Valentin Parmon, Elena Savinova

[Tuning the Morphology and Surface Composition as a Means for Improving the Activity of Ni in Hydrogen Electrode Reactions in Alkaline Medium](#)

s07-145

Toshiaki Yamaguchi (Inorganic Functional Materials Research Institute, National Institute of AIST, Nagoya, Japan), Hiroyuki Shimada, Haruo Kishimoto, Tomohiro Ishiyama, Ryosuke Atsumi, Yoshinobu Fujishiro

[Electrochemical Promotion of Co-Electrolysis of CO₂ and H₂O ~ Highly Effective Methanation Electrolysis Cell ~](#)

Symposium 8 Novel Materials and Devices for Energy Storage: Capacitors

Electrical double-layer

s08-001

Pawel Jezowski (Institute of Chemistry and Technical Chemistry, Poznan University of Technology, Poznan, Poland), Paulina Bujewska, Krzysztof Fic, François Béguin

[Expansion of activated carbon electrode during EDL charging in various salt aqueous electrolytes](#)

s08-002

Monchai Jitvisate (Nanoionics, MESA+ Institute for Nanotechnology, University of Twente, Enschede, Netherlands), James R. T. Seddon

[The Role of Band-bending on the Double Layer Capacitance at Room Temperature Ionic Liquid/Carbon Interfaces](#)

s08-003

Anton Volkov (Laboratory of Organic Electronics, ITN, Linköping University, Norrköping, Sweden), Kosala Wijeratne, Evangelia Mitra, Klas Tybrandt, Magnus Berggren, Xavier Crispin, Igor V. Zozoulenko

[The model for capacitive charging of conducting polymers](#)

Electrolytes for capacitors

s08-004

Samia Amara (Matériaux, CEA Le Ripault, University of Tours, Monts, France), Mérièm Anouti, Laure Timperman, Joël Toulc'Hoat, Agnès Biller, Hervé Galiano

[Comparative Study of Electrolytes Containing Sodium or Potassium Salts for Activated Carbon-Based Supercapacitor](#)

s08-005

Anthony Rennie (Department of Chemical & Biological Engineering, University of Sheffield, Sheffield, United Kingdom), Vitor L. Martins, Roberto M. Torresi, Peter Hall

[Electrochemical Stability in Ionic Liquid based EDLCs](#)

Hybrid systems

s08-006

Qamar Abbas (Institute of Chemistry and Technical Electrochemistry, Poznan University of Technology, Berdychowo 4, 60-965, Poznan, Poland), Patryk Przygocki, François Béguin

[Low temperature performance of hybrid supercapacitors in aqueous electrolyte](#)

s08-007

Ilona Acznik (Department of New Technologies for Energy Storage, Institute of Non-Ferrous Metals Division in Poznan, Poznań, Poland), Katarzyna Lota, Agnieszka Sierczynska

[Reduced Graphite Oxide as Electrode Material for High-Energy Storage Systems](#)

s08-008

Arenst Andreas Arie (Chemical Engineering, Parahyangan Catholic University, Bandung, Indonesia), Hans Kristianto, Martin Halim, Joong Kee Lee

[Biomass based Activated Carbons as Cathode Materials for Li Ion Capacitors](#)

s08-009

Pawel Jezowski (Institute of Chemistry and Technical Chemistry, Poznan University of Technology, Poznan, Poland), Krzysztof Fic, Olivier Crosnier, Thierry Brousse, François Béguin

[Lithium-ion capacitor based on in-situ pre-lithiation of graphite electrode by lithium rhenium oxide](#)

s08-010

Simon Lindberg (Physics, Chalmers, Gothenburg, Sweden), Florian Nitze, Aleksandar Matic

[High energy-density hybrid supercapacitors: Combining high-voltage window ionic liquids with MnO₂-nanomaterials](#)

s08-011

Krzysztof Wasinski (Department of Advanced Materials and Analytics, Institute of Non-Ferrous Metals Division in Poznan, Poznan, Poland), Paulina Polrolniczak, Mariusz Walkowiak

[Sodium manganese oxides as electrode materials in hybrid supercapacitor](#)

Materials for electrochemical capacitors

s08-012

Abd Almonam Baleg (Chemistry, University of the Western Cape, Cape town, South Africa), Nazeem Jahed, Emmanuel Iwuoha

[Synthesis and Characterization of Graphene Stabilized Conducting Dendritic Star Copolymer for Supercapacitor Systems](#)

s08-013

Vinoth Ganesan (Department of Chemistry, Kongju National University, Kongju, Korea), Parthiban Ramasamy, Jong-soo Lee

[Copper Germanium Selenide Nanosheets for Electrochemical Supercapacitors](#)

s08-014

Tao Li (College of Materials Science and Engineering, Donghua University, Shanghai, China), Zongyi Qin, Banglei Liang, Dandan Jin

[One-pot Synthesis and Electrochemical Properties of Polyaniline Nanofibers by Tuning Acid-base Property of Reaction Medium](#)

s08-015

Banglei Liang (College of Material Science and Engineering, Donghua University, Shanghai, China), Zongyi Qin, Tao Li

[Polyaniline Nanofibers Prepared under Flowing Condition for Electrochemical Energy Storage](#)

s08-016

Katarzyna Lota (Central Laboratory of Batteries and Cells, Institute of Non-ferrous Metals Department in Poznan, Poznan, Poland), Ilona Acznik, Agnieszka Sierczynska, Grzegorz Lota

[Capacitance Properties of Polypyrrole/Carbon Nanotubes Composites](#)

s08-017

Katarzyna Lota (Central Laboratory of Batteries and Cells, Institute of Non-ferrous Metals Department in Poznan, Poznan, Poland), Ilona Acznik, Agnieszka Sierczynska, Grzegorz Lota

[The Capacitance Properties of Activated Carbon Obtained From Polysaccharides as the Electrode Material for Electrochemical Capacitors](#)

s08-018

Helena Matabosch Coromina (School of Chemistry, University of Nottingham, Nottingham, United Kingdom), Darren A. Walsh

[Activated Carbon Nanotube Electrodes for Simultaneously High-Energy/High-Power Supercapacitors](#)

s08-019

Zongyi Qin (College of Materials Science and Engineering, Donghua University, Shanghai, China), Pengfei Qian, Tao Li, Banglei Liang, Dandan Jin

[Composite Nanofibers by Coating Polypyrrole on The Surface of Polyaniline Nanofibers Formed in Presence of Phenylenediamine as Electrode Materials in Neutral Electrolyte](#)

s08-020

Adam Slesinski (Institute of Chemistry and Technical Electrochemistry, Poznan University of Technology, Poznan, Poland), Adam Kolodziej, Krzysztof Fic, Elzbieta Frackowiak

[Chitin as a binder for electrochemical capacitor electrode](#)

s08-022

Zhaohui Wang (Department of Materials Chemistry-The Angström Laboratory, Uppsala University, Uppsala, Sweden), Petter Tammela, Maria Strømme, Leif Nyholm

[Nanocellulose Composites for Soft Capacitive Storage](#)

s08-023

Yue Xu (Department of Applied Chemistry, Tianjin University, Tianjin, China), Ying Tao, Xiaoyu Zheng, Hongyun Ma, Jiayan Luo, Feiyu Kang, Quan-Hong Yang

[Metal-free Composite Electrode for Supercapacitor with a Super High Volumetric Capacitance](#)

s08-024

Peng Yan (College of Materials Science and Chemical Engineering, Harbin Engineering University, Harbin, China), Guiling Wang, Sainan Yang

[FeOOH electrodeposited on Ag decorated ZnO nanorod for electrochemical energy storage](#)

Pseudocapacitance

s08-025

Alberto Adán-Mas (Centro de Química Estrutural CQE, Instituto Superior Técnico, University of Lisbon, Lisboa, Portugal), Raquel Duarte, Teresa María Silva, Liliane Guerlou-Demourgues, M. Fatima Montemor

[Investigation of Electrodeposited Composites of Nickel and Cobalt Hydroxides with Electrochemically Reduced Graphene Oxide for Redox Capacitor Applications.](#)

s08-026

Chung-Hsien Chuang (Department of Chemical Engineering, National Taiwan University, Taipei, Taiwan), Sheng-Siang Huang, Bing-Yi Shih, Yu-Ting Weng, Nae-Lih Wu

[Novel Ti₄O₇/MnO₂ Pseudocapacitive Composite for High Energy Density and Stability Supercapacitor](#)

s08-027

Xiaoxia Liu (Chemistry Department, Northeastern University, Shenyang, China), Yu Song

[Electrochemical Partial Exfoliation of Graphene and its Integration with Pseudocapacitive Materials](#)

s08-028

Milla Suominen (Department of Chemistry, University of Turku, Turku, Finland), Pia Damlin, Carita Kvarnström

[Capacitance Properties of Polyazulene in Ionic Liquids](#)

s08-029

Kush Upadhyay (Chemical Engineering, Instituto Superior Tecnico, Lisbon, Portugal), Tuyen Nguyen, M. Fatima Montemor

[Electrodeposited MoO_x as an Anode Material for Redox Supercapacitor Application](#)

s08-030

Chao-hong Wang (Department of Chemical Engineering, National Chung Cheng University, Chia-yi, Taiwan), Han-peng Tsai

[Fabrication of \(Co,Ni\)\(OH\)₂ by hydrolysis using ZnO nanorods as a template for high-performance supercapacitor](#)

s08-031

Kai Wang (Institute of Electrical Engineering, Chinese Academy of Sciences, Beijing, China), Xiong Zhang, Yanwei Ma

[High Performance Flexible, Solid-state Supercapacitors](#)

Supercapacitor

s08-032

Abdulhamit Aydin (Electrochemistry, Technische Universität Chemnitz, Chemnitz, Germany), Rudolf Holze, Nora Younadam

[Improved Supercapacitor Electrode Performance of Electrodeposited Nickel Hydroxide by Addition of Surfactants](#)

s08-033

Nicolas Jäckel (Energy Materials, INM- Leibniz Institute for New Materials, Saarbrücken, Germany), Daniel Weingarth, Anna Schreiber, Benjamin Krüner, Marco Zeiger, Aura Tolosa, Mesut Aslan, Volker Presser

[Performance evaluation of conductive additives for supercapacitors](#)

s08-034

Tae-Ho Kim (Center for membranes, Korea Research Institute of Chemical Technology, Daejeon, Korea), Jae Hee Han, Byoung Gak Kim

[Macroporous Carbon Materials with High Surface Area Derived from PIM-1 for Electrochemical Energy Storage](#)

s08-035

Jeng-Yu Lin (Department of Chemical Engineering, Tatung University, Taipei City, Taiwan), Tsung-Wu Lin, Chao-Shuan Dai, Ting-Ti Tsai, Shu-Wei Chou, Hsin-Hui Shen

[Advanced asymmetric supercapacitor based on cobalt sulfide/3D graphene composite and graphene hydrogel](#)

s08-036

Anna Lisowska-Oleksiak (Chemistry and Technology of Functional Materials, Gdansk University of Technology, Gdansk, Poland), Mariusz Szkoda, Katarzyna Siuzdak, M. Sawczak, Konrad Trzcinski

[Electrochemical Characterization of PEDOT:PSS Electrodeposited onto Hydrogenated TiO₂ Nanotubes/BiVO₄ Electrodes](#)

s08-037

Antonio Angel Moya (Physics, University of Jaén, Jaén, Spain)

[Interpretation of High-Frequency Electrochemical Impedances of Commercial Electric Double Layer Capacitors](#)

s08-038

Tamás Pajkossy (Interfaces, Institute of Materials and Environmental Chemistry, Budapest, Hungary)

[Characterization of CNT layers by EIS of multisine perturbation](#)

s08-039

Antonia Stoyanova (Nanoscaled Materials, Institute of Electrochemistry and Energy Systems, Sofia, Bulgaria), Galya Ivanova, Mladen Mladenov, Raicho Raicheff

[MnO₂-based Nanocomposites as Electrode Materials for Hybrid Supercapacitor Systems in Aqueous Electrolyte](#)

s08-040

Chau Cam Hoang Tran (Indre-et-Loire, François Rabelais University, Tours, France), Jesus Santo-Pena, Christine Damas

[Synthesis of mesoporous MnO₂ by alkene oxidation using soft template for electrochemical energy storage](#)

s08-041

Chau Cam Hoang Tran (Indre-et-Loire, François Rabelais University, Tours, France), Jesus Santo-Pena, Christine Damas

[Synthesis of MnO₂ by electrodeposition using hard template electrochemical energy storage](#)

s08-042

Joshua Whittam (Chemistry, University of Southampton, Southampton, United Kingdom), Andrew Hector

[The Application of Titanium Nitride in Supercapacitors.](#)

s08-043

Hongyao Xu (College of Materials Science and Engineering, Donghua University, Shanghai, China), Shanyi Guang, Shuishui Gong, Gang Wei

[The Influence of Chemical Functionalization of Graphene on Morphology Structure and Performance of Ordered Nanostructured Three-dimensional \(3D\) Array Polyaniline-graphene Composites with High Electric Capacity](#)

s08-044

Zhigang Zeng (Department of Physics, Shanghai University, Shanghai, China), Xiaobo Shi, Erjuan Guo, Xiao Long

[All-solid-state micro-supercapacitors based on hierarchical manganese oxide interdigitated electrodes](#)

Symposium 9 Capacitive Electrodes for Environmental Technology

Capacitive deionization

s09-001

Yi An Chen (Graduate Institute of Environmental Engineering, National Taiwan University, Taipei, Taiwan), Chia-Hung Hou

[Improved Desalination Performance of Bio-treated Domestic Wastewater Effluent Using Asymmetric Capacitive Deionization for Water Reuse](#)

s09-002

Hagai Cohen (Mechanical Engineering, Technion, Haifa, Israel), Shaked Ein Eli, Matthew Suss

[Hybrid suspension electrodes: combining fluidized beds and slurries](#)

s09-003

Yang Gui (Materials Science and Engineering, National University of Singapore, Singapore, Singapore)

[Study on the removal of lead \(II\) \(Pb²⁺\) ions from semiconductor industrial waste water using combined electroplating and capacitive desalination](#)

s09-004

Eric Guyes (Faculty of Mechanical Engineering, Technion Israel Institute of Technology, Haifa, Israel), Amit Shocron, Maarten Biesheuvel, Matthew Suss

[Flow-Through Electrode Capacitive Deionization Theory and Experiments](#)

s09-005

Jae Kwang Lee (Research Institute for Solar and Sustainable Energies, Gwangju Institute of Science and Technology, Gwangju, Korea), Tuan Ngoc Trinh, Sangho Chung, Hansaem Jang, Jaeyoung Lee

[The activated carbon electrode from waste coffee grounds for capacitive deionization](#)

s09-006

Tania Mubita (Environmental Technology, Wetsus, Wageningen University, Leeuwarden, Netherlands), Jouke Dykstra, Slawomir Porada, Albert van der Wal, Maarten Biesheuvel

[Dynamic Theory of Ion Adsorption in Porous Carbon Electrodes](#)

s09-007

Alexandra Rommerskirchen (Chemical Process Engineering, DWI - Leibniz Institute for Interactive Materials, Aachen, Germany), Burkhard Ohs, Karl Hepp, Robert Femmer

[Modelling Flow-electrode Capacitive Deionization](#)

s09-008

Luis Ruotolo (Chemical Engineering, Federal University of Sao Carlos, Sao Carlos, Brazil), Julio Lado, Rafael Zornitta, Mariana Martins, Felipe Calvi

[Study of the Impact of Surface Oxygen Groups and Electrode Pore Size Distribution on the CDI Performance](#)

s09-009

Jihyun Yu (School of Chemical and Biological Engineering, Seoul National University (SNU), Seoul, Korea), Taeyoung Kim, Junil Kang, Kyusik Jo, Jeyong Yoon

[Initial Microbial Adhesion and Biofilm Formation in Capacitive Deionization Process](#)

Electrochemical transformation of micropollutants

s09-010

Ruiter Moraes (College of Pharmacy, Federal University of Goiás, Goiânia, Brazil), Luane Garcia, Mariângela Santiago, Cassiano Pacheco, German Sanz Lobon, Eric Gil

[Anodic Remediation of Estrogen 17 \$\alpha\$ -Ethinylestradiol](#)

Environmental technology

s09-011

Demetra S. Achilleos (Department of Chemical Engineering, Massachusetts Institute of Technology, Cambridge, USA), T. Alan Hatton

[Pseudocapacitive Separation Technology based on Molecular Selectivity](#)

s09-012

Soliu O. Ganiyu (Geomaterials and Environment, Universite Paris Est Marne La Vallee, Marne La Vallee, France), Thi-Xuan-Huong Le, Mikhael Bechelany, Eric Van Hullebusch, Mehmet A. Oturan, Marc Cretin

[Synthesis, characterization and application of self-catalyzed layered double hydroxide coated carbon-felt cathode in electro-Fenton's degradation of organic pollutants](#)

s09-013

Jorge Juárez-Gómez (Centro Conjunto de Investigación en Química Sustentable, Universidad Autónoma del Estado de México, Toluca, Mexico), Gabriela Roa-Morales, Patricia Balderas-Hernandez, Maria Teresa Ramirez-Silva, Mario Romero-Romo

[Electrochemical Determination of Mercury ions in Samples Treated With Allium Cepa and its comparison with UV-Vis spectroscopy](#)

s09-014

Juan Manriquez (Dept. of Research, CIDETEQ, Pedro Escobedo, Mexico), Saachitee Murcio-Hernández, Silvia-Viridiana-Aideé Munguía-Galván, Tzayam Pérez-Segura, Silvia Gutierrez-Granados, Gilberto Carreño-Aguilera, José de Jesús Pérez-Bueno, Julieta Torres-González, Adrián Rodríguez-García

[Electrochemical mineralization of synthetic human urine contained in alkaline aqueous solution and the simultaneous H₂ generation from an electrolysis cell containing a Ni\(II\)cyclam-modified nanoporous TiO₂-anode and a Pt cathode](#)

s09-015

Marilia Pupo (Process Engineer, Tiradentes University, Aracaju, Brazil), Letícia Silva, Géssica Santos, Katlin Eguiluz, Giancarlo Salazar-Banda

[DSA synthesis using a thermal decomposition method applying ionic liquid – a study on the influence of heating rate](#)

s09-016

Giancarlo Salazar-Banda (Post-Graduação em Engenharia de Processos, Universidade Tiradentes, Aracaju, Brazil), Tarciso Santos, Carlos Alberto Martinez-Huitile, Katlin Eguiluz

[Highly active Ti/\(RuO₂\)_x-\(Sb₂O₅\)_y anodes synthesized by ionic liquid-thermal decomposition method](#)

s09-017

Francesca Soavi (Dipartimento di Chimica, University of Bologna, Bologna, Italy), Alexey Serov, Catia Arbizzani, Plamen Atanassov, Carlo Santoro

[Microbial Fuel Cell Integrated with Self-Powered Supercapacitor](#)

Mixed capacitive-Faradaic processes

s09-018

Jürgen Fuhrmann (Numerical Mathematics and Scientific Computing, Weierstrass Institute, Berlin, Germany), Christian Merdon

[A Thermodynamically Consistent Numerical Approach to Nernst-Planck-Poisson Systems with Volume Constraints](#)

s09-019

Xiao Su (Chemical Engineering, Massachusetts Institute of Technology, Cambridge, USA), T. Alan Hatton

[Asymmetric Pseudocapacitors for Environmental Separations and Water Remediation: Targeting Contaminants of Emerging Concern](#)

Porous electrode theory

s09-020

Ben Erné (Physical and Colloid Chemistry, Debye Inst. Nanomater. Sci., Utrecht University, Utrecht, Netherlands)

[Calorimetry of Electric Double Layer Formation at CDI Electrodes](#)

s09-021

Ruediger Mueller (Thermodynamics and Phase Transitions, Weierstrass Institute, Berlin, Germany), Wolfgang Dreyer, Clemens Guhlke

[New insights into Butler-Volmer kinetics from thermodynamic modeling](#)

Porous electrodes

s09-022

Zeliha Ertekin (Chemistry, Hacettepe University, Ankara, Turkey), Kadir Pekmez

[Characterization of electrosynthesized coloured TiO_x thin films electrodes](#)

Resource recovery from water

s09-023

Li-Ching Chung (Material and Chemical Research Laboratories, Industrial Technology Research Institute (ITRI), Hsinchu, Taiwan), Po-I. Liu, Hsin Shao, Teh-Ming Liang, Min-Chao Chang, Ren-Yang Horng

[Microwave-assisted synthesis of nanocrystalline layered double hydroxide/activated carbon electrode material for the selective electrosorption of phosphate ion](#)

Symposium 10 Electroactive, Functionalized and Nanostructured Materials and Composites: Modern Trends in Synthesis and Applications

(Electro)catalysis

s10-001

Gema Cabello (Department of Chemistry, Federal University of São Carlos, São Carlos, Brazil), Rogério A. Davoglio, Ernesto C. Pereira, Sonia R. Biaggio

[Pt-Au Bimetallic Nanoparticles with Enhanced Catalytic Activity Toward the Oxidation of Formic Acid](#)

s10-002

Richard Doyle (MicroNanoSystems Centre, Tyndall National Institute, Cork, Ireland)

[Bifunctional Oxygen Catalysis at Thin Layer Iron Oxide Microelectrode Arrays](#)

s10-003

Daniel Escalera López (School of Chemical Engineering, University of Birmingham, Birmingham, United Kingdom), Yubiao Niu, Jin Yin, Richard E. Palmer, Neil Rees

[Magnetron-sputtered Ni-doped MoS₂ nanoclusters for the hydrogen evolution reaction](#)

s10-004

Simon Geiger (Department of Interface Chemistry and Surface Engineering, Max-Planck-Institut für Eisenforschung GmbH, Düsseldorf, Germany), Olga Kasian, Buddha Shrestha, Andrea M. Mingers, Karl J.J. Mayrhofer, Serhiy Cherevko

[Improving Utilization of Catalysts for Acidic Water Splitting: Electrochemically Formed High-Surface-Area Iridium Oxides](#)

s10-005

Burkhard Hecker (Department of Chemistry, University of Oldenburg, Oldenburg, Germany), Isaac Adjei Safo, Mehtap Oezaslan

[Reactivity and Selectivity of Nanoporous Copper for the Electrochemical CO₂ Reduction](#)

s10-006

Yan-Xia Jiang (Department of Chemistry, Xiamen University, Xiamen, China), Xi-Ming Qu, Bin-Wei Zhang, Shi-Gang Sun

[Synthesis of PtPb nanodendrites with enhanced activity for electrooxidation of formic acid](#)

s10-007

Song-Zhu Kure-Chu (Department of Chemistry and Bioengineering, Iwate University, Morioka, Japan), Takuto Kawahara, Hiroki Sasaki, Hitoshi Yashiro, Kuniaki Sasaki

[Nanoporous Ni-Pd/Al₂O₃ Composite Films on Al as Catalytic Electrodes in Ethanol Oxidation for Direct Ethanol Fuel Cells](#)

s10-009

Shiva Mohajernia (Department of Materials Science, WWIV-LKO, Friedrich-Alexander-Universität Erlangen-Nürnberg, Erlangen, Germany), Anca Mazare, Patrik Schmuki

[Self-organized, free-standing TiO₂ nanotube membranes: Effect of different ions on flux through membranes](#)

s10-010

Shiva Mohajernia (Department of Materials Science, WWIV-LKO, Friedrich-Alexander-Universität Erlangen-Nürnberg, Erlangen, Germany), Anca Mazare, Patrik Schmuki

[Permeation characteristics of self-organized, free-standing TiO₂ nanotube membrane](#)

s10-011

Sara Morandi (Chemistry, Università degli Studi di Milano, Milano, Italy), Vladimiro Dal Santo, Cristina Locatelli, Francesco Malara, Alessandro Minguzzi, Alberto Naldoni, Sandra Rondinini, Alberto Vertova

[Design, Screening and Performances of Innovative Hematite/Overlayers Architectures](#)

s10-012

Justyna Orłowska (Faculty of Chemistry, University of Warsaw, Warsaw, Poland), Iwona A. Rutkowska, Pawel J. Kulesza

[Development of Efficient Semi-Solid Redox Electrolytes/Charge Mediators through Incorporation of Nobel Metal Nanoparticles to Iodine/Iodide Ionic Liquids](#)

s10-013

Ali Riza Ozkaya (Department of Chemistry, Marmara University, Istanbul, Turkey)

[Electrochemical Redox and Electrocatalytic Properties of Dinuclear Ball-type Phthalocyanines](#)

s10-014

Athanasios Papaderakis (Department of Chemistry, Laboratory of Physical Chemistry, Aristotle University of Thessaloniki, Thessaloniki, Greece), Sotiris Sotiropoulos, Stella Balomenou, Dimitrios Tsiplakides

[Ir-Ni and IrO_x-Ni electrode coatings prepared by a galvanic replacement process for electrochemical water splitting](#)

s10-015

Ursa Petek (Laboratory for Materials Chemistry, National Institute of Chemistry, Ljubljana, Slovenia), Francisco Ruiz-Zepeda, Primož Jovanovic, Martin Sala, Vid Simon Selih, Jonas Pampel, Tim-Patrick Fellingner, Marjan Bele, Miran Gaberscek

[Single Atoms of Pt on Porous Nitrogen-Doped Carbon for Electrocatalysis](#)

s10-016

Morten Gildsig Poulsen (Department of Chem. Eng., Biotech. and Environ. Tech., University of Southern Denmark, Odense, Denmark)

[Tungsten Carbide Prepared by Self-Propagating High-Temperature Synthesis as a Catalyst Support Material in Proton Exchange Membrane Fuel Cells](#)

s10-017

F. Javier Recio (Departamento de Química Inorgánica, Pontificia Universidad Católica de Chile, Santiago de Chile, Chile), César Zúñiga, Venegas Ricardo, Jose H. Zagal

[Study of the formal potential of the pyrolyzed catalysts as reactivity index for ORR in basic media.](#)

s10-018

Mojtaba Safari (Electrochemical Research Group, Hafadaran Research Centre, Tehran, Iran, Tehran, Iran)

[Voltammetric Detection of perphenazine on a functionalized Multiwall Carbon Nanotube modified electrode](#)

s10-019

Nedjeljko Seselj (Department of Chemistry, Technical University of Denmark, Kgs. Lyngby, Denmark), Jens Ulstrup, Jingdong Zhang

[Graphene Supported Au-Pt Core-Shell Catalyst Electrocatalysis for Formic Acid Oxidation](#)

s10-020

Zbigniew Stojek (Faculty of Chemistry, University of Warsaw, Warsaw, Poland), Marcin Mackiewicz, Marcin Karbarz

[Chemical and Electrochemical Properties of Novel Environmentally Sensitive Microcomposites](#)

s10-021

Hui Sun (New Energy Research Institute, China University of Petroleum, Beijing, Beijing, China), Xingyu Ma, Haixia Su, Xin Zhang

[Electrochemical method proude N-rGO with enhanced HER performance](#)

s10-022

Giovanni Valenti (Chemistry G. Ciamician, University of Bologna, Bologna, Italy), Alessandro Boni, Tiziano Montini, Paolo Fornasiero, Maurizio Prato, Francesco Paolucci

[Driving the selectivity of electrochemical CO₂ reduction to formic acid: synergic effects in a C-based heterostructure](#)

s10-023

Zhiyuan Wang (Fundamental Electrochemistry (IEK-9), Forschungszentrum Jülich GmbH, Jülich, Germany), Hermann Tempel, Peter Jakes, Svitlana Eurich, L.G.J. de Haart, Hans Kungl, Ruediger-A. Eichel

[Lanthanum – Strontium - Iron - Perovskites as Catalysts for OER in alkaline media](#)

s10-024

Shu Yang (Chemistry, University of Strasbourg, Strasbourg, France), Antoine Bonnefont, Laurent Ruhlmann

[Electrocatalytic reduction of NO_x on polyoxometalate-stabilized nanoparticles](#)

s10-025

Dejin Zang (Dept. of Chemistry, University of strasbourg, Strasbourg, France), Antoine Bonnefont

[RGO/Polyoxometalates@Pt Functionalized Electrodes for Improved Electrocatalytic Hydrogen Production](#)

Electroactive polymer

s10-026

Lisa Akerlund (Engineering Sciences, Uppsala University, Uppsala, Sweden), Rikard Emanuelsson, Martin Sjödin, Maria Strømme, Adolf Gogoll

[Quinone based conducting redox polymers for renewable energy storage](#)

s10-027

Cíntia Corrêa (Chemical institute, Universidade de São Paulo, São Paulo, Brazil), Roberto M. Torresi, Tânia Benedetti

[Electrochemical and Chromogenic Behavior of Poly\(Ionic Liquid\) Functionalized with Viologen](#)

s10-028

Yutaka Harima (Graduate School of Engineering, Hiroshima University, Higashi-Hiroshima, Japan), Jun Yano, Ichiro Imae

[Thermoelectric Performances of Graphene/Polyaniline Composites Electrosynthesized by a Facile One-Step Process](#)

s10-029

Oana Hosu (Department of Analytical Chemistry, Iuliu Hatieganu University of Medicine and Pharmacy, Cluj Napoca, Romania), Madalina Barsan, Cecilia Cristea, Robert Sandulescu, Christopher Brett

[New Poly\(Methylene Blue\) Nanostructured Films from Deep Eutectic Solvents: Synthesis, Characterization and Application](#)

s10-030

Hao Huang (Department of Engineering Sciences, Uppsala University, Uppsala, Sweden), Christoffer Karlsson, Maria Strømme, Adolf Gogoll, Martin Sjödin

[Interaction of Polymer Backbone and Pendant Group in Conducting Redox Polymers](#)

s10-031

Dmitry Konev (EMEE, MUCTR, Moscow, Russia), Olga Istakova, Olga Sereda, Maria Shamraeva, Mikhail Vorotyntsev

[Spectroelectrochemistry in the Course of Mg \(II\) Porphine Polymerization as a Way to Determine the Molecular Structure of Forming Electroactive Polyporphine Film](#)

s10-032

Dmitry Konev (EMEE, MUCTR, Moscow, Russia), Olga Istakova, Dinara Khairullina, Mikhail Vorotyntsev

[Influence of Various Solvents on the Electropolymerization Process of Mg \(II\) Porphine and Properties of Electroactive Polyporphine Films](#)

s10-033

Alexander Nekrasov (Russian Academy of Sciences, A.N. Frumkin Inst. of Physical Chemistry & Electrochemistry, Moscow, Russia), Oxana Gribkova, Olga Iakobson, Viktor Ivanov, Anatoly Vannikov

[Raman Spectroelectrochemical Study of Polyaniline Doped with Polymeric Sulfonic Acids of Different Structure](#)

s10-034

Alex Palma-Cando (Macromolecular Chemistry, Bergische Universität Wuppertal, Wuppertal, Germany), Gunther Brunklaus, Ullrich Scherf

[Thiophene-Based Microporous Polymer Networks via Chemical or Electrochemical Oxidative Polymerization](#)

s10-035

Martin Pfaffeneder-Kmen (Department of Physical Chemistry, Vienna, Austria), Wolfgang Kautek, Günter Trettenhahn

[Localized Reduction and Patterning of Graphene Oxide A Scanning Electrochemical Microscope Study](#)

s10-036

Morten Gildsig Poulsen (Department of Chem. Eng., Biotech. and Environ. Tech., University of Southern Denmark, Odense, Denmark)

[Improved Durability of Proton Exchange Membrane Fuel Cell Electrocatalytic Layers by Introduction of Tin Dioxide Particles by an Ion Exchange Process](#)

s10-037

Sebastien Rolle (Institut de Chimie Moléculaire de l'Université de Bourgogne, Université de Bourgogne, Dijon, France), Dominique Lucas, Charles H. Devillers, Christine Stern, Dmitry Konev, Mikhail Vorotyntsev, Ksenia V. Lizgina, Olivier Heintz, Frédéric Herbst

[Synthesis and characterization of new conducting polymers derived from cobalt porphine](#)

s10-038

Mia Sterby (Department for Engineering Sciences, Uppsala University, Uppsala, Sweden), Rikard Emanuelsson, Maria Strømme, Adolf Gogoll, Martin Sjödin

[Linker Effect in PEDOT/Quinone Organic Battery Materials](#)

s10-039

Janno Torop (Institute of Technology, University of Tartu, Tartu, Estonia), Daria Nevstrueva, Kirill Murashko, Veiko Vunder, Alvo Aabloo, Mika Mänttäri, Juha Pyrhönen, Tuomas Koironen

[Electroactive and Capacitive Ionogel Actuators from Natural Cellulose](#)

s10-040

Janno Torop (Institute of Technology, University of Tartu, Tartu, Estonia), Alvo Aabloo, Edwin Jager

[Electroactive Polypyrrole/Carbide-derived Carbon Hybrid Materials](#)

s10-041

Li Yang (Engineering Sciences, Uppsala University, Uppsala, Sweden), Xiao Huang, Martin Sjödin, Adolf Gogoll, Maria Strømme

[Terephthalate-functionalized Conducting Redox Polymers for Energy Storage](#)

Electrodeposition

s10-042

Salem Boudinar (Physics, University of Mouloud Mammeri, Tizi-Ouzou, Algeria), Nassima Benbrahim, Baya Benfedda, Abdelaziz Kadri, Eric Chainet, Lamia Hamadou

[Effect of the nanoporous alumina thickness on the synthesis of Mn-Bi nanowires](#)

s10-043

Agnieszka Brzózka (Institute of Chemistry and Technical Electrochemistry, Poznan University of Technology, Poznan, Poland), Anna Brudzisz, Grzegorz Sulka

[Simple and Inexpensive Electrochemical Method of the AAO Template Preparation for Synthesis of Nanomaterials](#)

s10-044

Sayantana Das (Faculty of Chemical Technology, Univerzita Pardubice, Pardubice, Czech Republic), Milos Krbal, Hanna Sopha, Jan M. Macak

[Electrochemical deposition of Cu\(In,Ge\)Se₂ semiconducting materials in self-organized anodic TiO₂ nanotubes](#)

s10-045

Humberto Gomez (Instituto de Química, Pontificia Universidad Católica de Valparaíso, Valparaíso, Chile), Francisco Catano, Ana Burgos

[Electrodeposited ZnO Nanorods as electron transporting material in organic-inorganic perovskite based solar cells](#)

s10-046

Elvira Gómez (Química Física, University of Barcelona, Barcelona, Spain), Luca Magagnin, Andrea Oriani, Paula Cojocar, Elisa Vallés

[Aluminium Electrodeposition from a Novel Hydrophobic Ionic Liquid](#)

s10-047

Tathagata Kar (Department of Energy Science and Engineering, Indian Institute of Technology Bombay, Mumbai, India), Ruttala Devivaraprasad, Manoj Neergat

[Electrodeposition and reduction of Graphene Oxide in Aqueous Electrolytes](#)

s10-048

Fernando Miguel (Fundamental Chemistry, Instituto de Química, Universidade de São Paulo, São Paulo, Brazil), Tânia Benedetti, Susana Cordoba de Torresi, Roberto M. Torresi

[QCM-D Studies of Polypyrrole Influence on Structure Stabilization of \$\beta\$ phase of Ni\(OH\)₂ Nanoparticles During Electrochemical Cycling](#)

s10-049

Marek Mooste (Institute of Chemistry, University of Tartu, Tartu, Estonia), Elo Kibena-Pöldsepp, Margus Marandi, Leonard Matisen, Väino Sammelselg, Kaido Tammeveski

[Characterization of Gold Electrodes Electrografted with Anthraquinone Groups Using the Rotating Disk Electrode Method](#)

s10-050

Emilio Navarrete (Instituto de Química, Pontificia Universidad Católica de Valparaíso, Curauama, Chile), Victor Rojas, Javier Roman, Mario Romero, Rodrigo Henríquez, Ricardo Schrebler, Ricardo Córdova, Eduardo Muñoz

[Study About Electrostatic Deposition of CdTe Quantum Dots on Glassy Carbon Electrodes.](#)

s10-051

Leszek Zaraska (Department of Physical Chemistry and Electrochemistry, Faculty of Chemistry, Jagiellonian University in Krakow, Krakow, Poland), Dominika Gilek, Karolina Gawlak, Marian Jaskula, Grzegorz Sulka

[Anodic formation of crack-free multilayered nanoporous tin oxides](#)

s10-052

Leszek Zaraska (Department of Physical Chemistry and Electrochemistry, Faculty of Chemistry, Jagiellonian University in Krakow, Krakow, Poland), Krystyna Mika, Karolina Syrek, Grzegorz Sulka

[ZnO nanowire arrays grown by simple anodic oxidation of Zn in bicarbonate electrolytes](#)

s10-053

Ridha Zerdoumi (Department of Chemistry, University of Biskra, Biskra, Algeria), Ali Ourari, Ramiro Ruiz-Rosas, Emilia Morallón

[The Effect of the Pulse Parameters on the Deposition of Platinum Nanoparticles on a Glassy Carbon-supported Catalyst for Ethanol Electro-oxidation](#)

Energy applications

s10-054

Seyyed Mohsen Beladi Mousavi (Institute of Chemistry of New Materials, University of Osnabrück, Osnabrück, Germany)

[Towards an Ultrafast Organic Energy Storage Material: Polyviologen / Reduced Graphene Oxide Nanocomposite](#)

s10-055

Ana Burgos (Instituto de Química, Pontificia Universidad Católica de Valparaíso, Valparaíso, Chile)

[Pulsed electrodeposition of tin sulfide thin films from dimethyl sulfoxide solutions](#)

s10-056

Christine Cachet-Vivier (Institut de Chimie et des Matériaux Paris-Est, Université Paris-Est Créteil - CNRS, Thiais, France), Stéphane Bastide, Claudia Zlotea, Yassine Oumellal, Michel Laurent, Michel Latroche

[Influence of nanosizing on hydrogen electrosorption properties of rhodium nanoparticles/carbon composites](#)

s10-057

Jean-Daniel Compain (Institut de Chimie, Université de Strasbourg, Strasbourg, France), Dejin Zang, Laurent Ruhlmann

[Hybrid Polyoxometalate / Porphyrin Modified Electrodes for Photocurrent Generation](#)

s10-058

Stefan Dilger (Materials for Energy Conversion, Empa: Swiss Federal Lab. for Materials Sci. and Tec., Dübendorf, Switzerland), Steve Landsmann, Corsin Battaglia, Simone Pokrant

[Increasing Conductivity with Carbon Nanotubes and Graphene Oxide in Composite Particle-based Photoanodes for Solar Water Splitting](#)

s10-059

Aliasghar Ensafi (Chemistry, Isfahan University of Technology, Isfahan, Iran)

[Preparation of Three-Dimensional Ruthenium Oxide/Exfoliated Graphene Oxide Based on Etching of Layered Double Hydroxides, Application for Hydrogen Evolution Reaction](#)

s10-060

Ramón M. Fernández-Domene (Ingeniería Química y Nuclear, Universitat Politècnica de València, Valencia, Spain), Rita Sánchez-Tovar, Bianca Lucas-Granados, José García-Antón

[Effect of rotation velocity during anodization on the photocatalytic performance of WO₃ nanoplatelets](#)

s10-061

Ramón M. Fernández-Domene (Ingeniería Química y Nuclear, Universitat Politècnica de València, Valencia, Spain), Rita Sánchez-Tovar, Bianca Lucas-Granados, José García-Antón

[Photostability of tree-like WO₃ nanoplatelets globular clusters](#)

s10-062

Sang-Beom Han (Chemical Engineering, Soongsil University, Seoul, Korea), Da-Hee Kwak, In-Ae Choi, Hyun-Suk Park, Jin-Young Park, Si-Jin Kim, Min-Cheol Kim, Kyung-Won Park

[Enhanced Oxygen Reduction Reaction of Electrodeposited Nanoporous PtY Alloy Electrodes](#)

s10-063

Imgon Hwang (Department of Materials and Engineering, FAU, WW4-LKO, Erlangen, Germany), Seulgi So, Anca Mazare, Patrik Schmuki

[Single-walled TiO₂ Nanotubes: Enhanced Carrier-transport Properties by TiCl₄-treatment](#)

s10-064

Si-Jin Kim (Chemical Engineering, Soongsil University, Seoul, Korea), Min-Cheol Kim, Gyu-Ho Lee, Hui-Seon Choe, Da-Hee Kwak, Sang-Beom Han, Sang-Hyun Moon

[Titanium oxide coated Li₂MnO₃ cathode materials for lithium-ion batteries](#)

s10-065

Min-Cheol Kim (Department of Chemical Engineering, Soongsil University, Seoul, Korea), Si-Jin Kim, Sang-Beom Han, Da-Hee Kawk, Gyu-Ho Lee, Hui-Seon Choe, Sang-Hyun Moon

[Improved electrochemical properties of shape controlled Cu₂O nanostructures as anodes for lithium-ion batteries](#)

s10-066

Bianca Lucas-Granados (Ingeniería Química y Nuclear, Universidad Politècnica de Valencia, Valencia, Spain), Bianca Lucas-Granados, Rita Sánchez-Tovar, Ramón M. Fernández-Domene, José García-Antón

[Effect of the annealing atmosphere and temperature on new iron oxide nanostructures](#)

s10-067

Bianca Lucas-Granados (Ingeniería Química y Nuclear, Universidad Politècnica de Valencia, Valencia, Spain), Rita Sánchez-Tovar, Ramón M. Fernández-Domene, José García-Antón

[Evaluation of the morphology of iron based photoelectrodes anodized at different rotation speeds](#)

s10-068

Selda Ozkan (Department of Materials Science, WW4-LKO, University of Erlangen-Nuremberg, Erlangen, Germany), Anca Mazare, Robert Hahn, Isotta Cerri, Patrik Schmuki

[Synthesis and Characterization of Self-organized Spaced TiO₂ NTs](#)

s10-069

Elisa Sechi (Ingegneria Meccanica, Chimica e dei Materiali, Università degli Studi di Cagliari, Cagliari, Italy), Michele Mascia

[Hybrid PANI/PSi electrodes: preparation and photocurrent performances at different wavelength](#)

s10-070

Hyunwoong Seo (Information Science and Electrical Engineering, Kyushu University, Fukuoka, Japan), Min-Kyu Son, Sota Tanami, Naho Itagaki, Kazunori Koga, Masaharu Shiratani

[Catalytic Activation of Polymer Composite Catalyst for Photochemical Solar Cells](#)

s10-071

Dheeraj Kumar Singh (Chemistry and Physics of Materials Unit, Jawaharlal Nehru Centre for Advanced Scientific Research, Bengaluru, India), Katla Sai Krishna, Srinivasan Harish, Srinivasan Sampath, Muthusamy Eswaramoorthy

[No More HF: Teflon-Assisted Ultrafast Removal of Silica to Generate High-Surface-Area Mesostructured Carbon for Enhanced CO₂ Capture and Supercapacitor Performance](#)

s10-072

Joanna Swider (Faculty of Chemistry, Jagiellonian University, Krakow, Poland), Molenda Marcin

[Optimization of Carbon Sources for Enhancing Conductivity and Electrochemical Properties of CCL/LiFePO₄ Composites](#)

s10-073

Rita Sánchez-Tovar (Ingeniería Química y Nuclear, Universidad Politecnica de Valencia, Valencia, Spain), Rita Sánchez-Tovar, Ramón M. Fernández-Domene, Maria Teresa Montañés, José García-Antón

[Effect of Hydrodynamic Conditions on Photocatalytic Activity of ZnO/ZnS Heterostructures](#)

s10-074

Rita Sánchez-Tovar (Ingeniería Química y Nuclear, Universidad Politécnica de Valencia, Valencia, Spain), Maria Jose Muñoz-Portero, Dionisio Garcia-Garcia, Bellatrix Vela-Diago, José García-Antón, Rita Sánchez-Tovar

[Effect of H⁺ and Li⁺ intercalation on WO₃ nanostructures anodized under dynamic conditions for hydrogen production](#)

s10-075

Aide M. Torres-Huerta (CIAMS, Instituto Politecnico Nacional/CICATA Unidad Altamira, Mexico, Mexico), David S. García-Zaleta, Miguel A. Domínguez-Crespo

[Synthesis of phase pure, dense fine grained ceramics by sol-gel technique of RE-substituted Bi_{1-x}RE_xFeO₃-nanopowders \(RE=La³⁺, Y³⁺, Dy³⁺, Ce³⁺\): structural, electrical and magnetic characterization](#)

Functionalization

s10-076

Ronghuan He (Chemistry, Northeastern University, Shenyang, China), Niya Ye, Jingshuai Yang, Yixin Xu, Dengji Zhang

[Organic-Inorganic Hybrid Anion Exchange Membranes Based on Quaternized Poly\(2,6-dimethyl-1,4-phenyleneoxide\) and 3-Glycidoxy-propyltrimethoxysilane](#)

s10-077

Atif Koca (Chemical Engineering Department, Marmara University, Istanbul, Turkey), Hakan Sarıcaayır, Cengiz Tüysüz

[Spectroelectrochemistry of Metallophthalocyanines Having Redox Active Metal Centers](#)

s10-078

Atif Koca (Chemical Engineering Department, Marmara University, Istanbul, Turkey), Duygu Akyüz, Hatice Dinçer

[Electrochromism of metallophthalocyanines immobilized with click electrochemistry](#)

s10-079

Mohamed Naimi (LEC/UERCA, Ecole Militaire Polytechnique, Algiers, Algeria), Abderrezak Abdi, Omar Aaboubi, Mohamed Trari, Mohamed Naimi

[Study on Structural, Morphological and Electrochemical Properties of Mesoporous Coox/Y Modified-Zeolites Sintered at High Temperature](#)

s10-080

Rasa Pauliukaite (Department of Nanoengineering, Center for Physical Sciences and Technology, Vilnius, Lithuania), Ausra Baradoke, Jurga Juodkazyte, Ignas Masilionis, Airina Mazetyte, Vytautas Navikas, Martynas Gavutis, Rasa Pauliukaite, Ramunas Valiokas

[Fabrication of Platinum Microelectrode for Detection of Hydrogen Peroxide](#)

s10-081

Grzegorz Sulka (Department of Physical Chemistry & Electrochemistry, Jagiellonian University in Krakow, Krakow, Poland), Anna Pawlik, Magdalena Jarosz

[Nanoporous Titanium Oxide Layers for Implantable Applications](#)

s10-082

Chia-Liang Sun (Dept. of Chem. and Mater. Eng., Chang Gung University, Taoyuan, Taiwan), Shun-Yi Lai, Chia-Heng Kuo, Chen-Fu Pan, Chun-Hao Su

[Synthesis of Activated Graphene Oxide Nanoribbons and Their Electrochemical Applications](#)

Nanocomposites

s10-083

Xochitl Dominguez-Benetton (Separation and Conversion Technology, VITO, Mol, Belgium)

[Gas-diffusion electrocrystallization](#)

s10-084

Bhushan Gadgil (Department of Chemistry, University of Turku, Turku, Finland), Pia Damlin, Carita Kvarnström

[Effect of Graphene Based Interfacial Layer on the Electrochromic Switching Kinetics](#)

s10-085

Marijana Kraljic Rokovic (Faculty of chemical engineering and technology, University of Zagreb, Zagreb, Croatia), Gabrijela Ljubek

[Graphene preparation by electrochemical exfoliation of natural graphite flakes](#)

s10-086

Rasa Pauliukaite (Department of Nanoengineering, Center for Physical Sciences and Technology, Vilnius, Lithuania), Raimonda Celiesiute, Aneta Radzevic, Airidas Zukauskas, Romualdas Trusovas, Gediminas Raciukaitis, Gediminas Niaura

[Laser-Patterned Graphene-Chitosan Composite for Sensing Applications](#)

s10-087

Mario Romero (Laboratorio de Electroquímica, Instituto de Química, Pontificia Universidad Católica de Valparaíso, Valparaíso, Chile), Rodrigo Henríquez, Enrique Dalchiale

[Electro-Synthesis and Characterization of Nanostructures Based PEDOTs/ZnO and its Possible Use in Photovoltaic Cells](#)

s10-088

Robert Sandulescu (Analytical Chemistry, Iuliu Hatieganu University of Medicine and Pharmacy, Cluj-Napoca, Romania), Luminita Fritea, Karine Gorgy, Alan Le Goff, Laurent Galmiche, Reynaldo Villalonga, Pierre Audebert, Serge Cosnier

Tetrazines in Aqueous Solution. Electrochemical and Fluorescent Studies

Sensors and electroanalysis

s10-089

Berna Dalkiran (Chemistry Department, Ankara University, Ankara, Turkey), Berna Dalkiran, Pinar Esra Erden, Esma Kilic

[Development of An Amperometric Galactose Biosensor Based on Graphene and Tricobalt Oxide Nanoparticles](#)

s10-090

Arnab Halder (DTU Chemistry, Technical University of Denmark, Kgs. Lyngby, Denmark), Jens Ulstrup, Qijin Chi

[Electrochemically active functionalization of graphene for development of prototype biosensing devices](#)

s10-091

Ceren Kacar (Chemistry Department, Ankara University, Ankara, Turkey), Ceren Kacar, Berna Dalkiran, Pinar Esra Erden, Esma Kilic

[Graphene/MWCNTs/Poly\(vinylferrocene\) Composite Based Amperometric Biosensor for Determination of L-lysine in Pharmaceuticals and Cheese](#)

s10-092

Lauro Kubota (Analytical Chemistry, Institute of Chemistry at Unicamp, Campinas, Brazil), José Barragan, Everson Da Silva

[Potential Relaxation in Copper Oxide Electrodes: A Novel Approach for Analytical Determinations in Alkaline Media](#)

s10-093

Andrew Leach (School of Chemistry, University of Southampton, Southampton, United Kingdom), John Chapples, Marvin Gayle, Keith Pratt, Andrea Russell

[Effect of Electrolyte Concentration on the Performance of Pt Based Oxygen Sensors](#)

s10-094

Shih Chien Lin (Chemical Engineering Department, National Taiwan University, New Taipei City, Taiwan), Ying-Chih Liao

[Development of a Multilayer Printed Sensor for Simultaneous Temperature and Humidity Sensing](#)

s10-095

Ruzniza Mohd Zawawi (Department of Chemistry, Faculty of Science, Universiti Putra Malaysia, UPM Serdang, Malaysia), Aini Suzana Che Ani, Alvin Lim Teik Zheng

[Vancomycin Nanohybrid Matrix-based Sensors for Enantioselective Electrochemical Recognition of Chiral Drugs](#)

s10-096

Jessica Márquez-León (Faculty of Chemical Sciences, Autonomous University of San Luis Potosí, San Luis Potosí, Mexico), Luis F. Chazaro-Ruiz, Gabriela Palestino

[Immobilization of cytochrome c on oxidized bamboo-like nitrogen doped multiwall carbon nanotubes and its application on amperometric H₂O₂ detection](#)

s10-097

Emilio Navarrete (Instituto de Química, Pontificia Universidad Católica de Valparaíso, Curauma, Chile), Rodrigo Henríquez, Ricardo Schrebler, Ricardo Córdova, Luis Aguilar, Manuel Bravo, Eduardo Muñoz

[Study About an Experimental Design for CdTe Quantum Dots Synthesis. Analysis of the Optical and Electrochemical Changes After their Interaction with Hydroxyl Radicals.](#)

s10-099

Ali Riza Ozkaya (Department of Chemistry, Marmara University, Istanbul, Turkey), Umit Ergin Ozen, Turgut Keles, Zekeriya Biyiklioglu, Atif Koca

[Electropolymerization of Metallophthalocyanines and their Application as Pesticide Sensors](#)

s10-100

Vanoushe Rahemi (Chemistry, University of Antwerp, Antwerpen, Belgium), Stanislav Trashin, Vera Meynen, Karolien De Wael

[An Adhesive Conducting Electrode Material Based on Commercial Mesoporous Titanium Dioxide As A Support For Horseradish Peroxidase For Bioelectrochemical Applications](#)

s10-101

Juan Arturo Squella (Department of Organic and Physical Chemistry, University of Chile, Santiago, Chile), Raúl Moscoso, Elizabeth Inostroza

[Voltammetric determination of 2-\(4-nitrophenyl\) 1, 3-oxazol entrapped on MWCNT modified electrode.](#)

s10-102

Meryck Ward (Chemistry, University of the Western Cape, Cape Town, South Africa), Priscilla Baker, Emmanuel Iwuoha, Pierre-Henri Aubert, Cedric Plesse

[Novel cross linked polymers for the Discrimination of Polycyclic Aromatic Hydrocarbons in aqueous systems](#)

Symposium 11 Electrochemical Engineering for Improvement of Process Sustainability

Beneficiation of secondary products

s11-001

José M. Bisang (PRELINE, Facultad de Ingeniería Química, Universidad Nacional del Litoral, Santa Fe, Argentina), Omar González Pérez

[Electrochemical Reduction of Nitrate in non-buffered \$K_2SO_4\$ Aqueous Solutions using an Activated Copper Rotating Cylinder Electrode](#)

s11-002

Elodie Guyot (CP2S équipe Chimie et Electrochimie des Matériaux, Institut Jean Lamour, Université de Lorraine/CNRS, Metz, France), Clotilde Boulanger

[Recovery of Indium by Electrochemical Junction Transfer](#)

s11-003

Hojin Hwang (School of Chemical Engineering, Chonnam National Engineering, Gwangju, Korea), Haemun Shin

[Preparation of \$ZnCo_2S_4\$ /carbon nano composites as anodes for lithium-ion batteries](#)

s11-004

Valentín Pérez-Herranz (Department of Chemical and Nuclear Engineering, Universitat Politècnica de València, Valencia, Spain), Jordi Carrillo-Abad, Montserrat García-Gabaldón, Emma M. Ortega

[The Effect of pH on Zinc Recovery from the Spent Pickling Baths of Hot Dip Galvanizing Industries.](#)

s11-005

Haemun Shin (School of Chemical Engineering, Chonnam National Engineering, Gwangju, Korea), Hojin Hwang

[Improved electrochemical performances of double-layered \$Cu_xCo_{3-x}O_4\$ microspheres for lithium ion batteries](#)

Coupling to green energy

s11-006

Chih-Yu Ma (Graduate Institute of Environmental Engineering, National Taiwan University, Taipei, Taiwan), Chia-Hung Hou

[Microbial Desalination Cell Combined with Membrane Capacitive Deionization for Wastewater Treatment and Desalination](#)

s11-007

Antonio Angel Moya (Physics, University of Jaén, Jaén, Spain)[Numerical Simulation of the Electrical Response of Ion-Exchange Membrane Systems under Reverse Electrodialysis Conditions](#)

s11-008

Manuel Andres Rodrigo (Chemical Engineering, Universidad de Castilla-la-Mancha, Ciudad Real, Spain), Carolina Risco, Rubén López-Vizcaíno, Cristina Sáez, Vicente Navarro, Jose Villaseñor, Pablo Cañizares[Electrokinetic remediation of soils polluted with pesticides: Flushing and fence technologies](#)

Electrochemical engineering

s11-009

Zaira Aguilar (División de Ingenierías, Universidad de Guanajuato, Guanajuato, Mexico), José L. Nava, Oscar Coreño[Electrochemical Incineration of Mordant Orange 1 Dye on a Dimensional Stable Anode \(DSA\) Fitted in a Divided Filter Press Flow Reactor](#)

s11-010

Christian E. Alvarez-Pugliese (Escuela de Ingeniería de Química, Universidad del Valle, Cali, Colombia), Jawer David Acuña-Bedoya, Lizeth Osorio-Mina, Nilson Marriaga-Cabrales, Fiderman Machuca-Martínez, Juan Manuel Barraza Burgos[Electrochemical Regeneration of Granular Activated Carbon using Boron Doped Diamond Anodes](#)

s11-011

Henry Bergmann (FB 6&7, Anhalt University, Köthen/Anh., Germany), Solomon Jembere[Studies on a Laboratory Rotating Disk Electrode \(RDE\)](#)

s11-012

Roel Bisselink (Functional Ingredients, TNO, Zeist, Netherlands), Roman Latsuzbaia[Electrosynthesis of 2,5-furandicarboxylic acid](#)

s11-013

Roel Bisselink (Functional Ingredients, TNO, Zeist, Netherlands), Joost van Erkel[Electrosynthesis of hydrogen peroxide](#)

s11-014

Erika Bustos (Science, Centro de Investigación y Desarrollo Tecnológico en Electroq, Pedro Escobedo, Mexico), Yenny Cruz, Ignacio González, Abel Ibañez-Huerta, Gabriela Castaño-Meneses, Alicia Callejas-Chavero, Daniela Pérez-Velázquez, Jesús Cárdenas, Roberto Frausto[Electrochemical Rehabilitation in situ on Saline Soil Using a 2D Circular Arrangement of Electrodes](#)

s11-015

Alejandro N. Colli (Laboratoire d'Electrochimie Physique et Analytique (LEPA), École Polytechnique Fédérale de Lausanne (EPFL), Sion, Switzerland), Alejandro N. Colli, José M. Bisang[Cumulative and Convergent Flow as a Means to Improve the Tertiary Current Distribution at Parallel-Plate Electrochemical Reactors](#)

s11-016

Gabriela Coria (Ingeniería en Geomática e Hidráulica, Universidad de Guanajuato, Guanajuato, Mexico), Ignasi Sirés, José L. Nava[Degradation of Naproxen by Electro-oxidation, Electro-Fenton and Photoelectro-Fenton](#)

s11-017

Martín Dávila (Fisicoquímica, Benemerita Universidad Autónoma de Puebla, Puebla, Mexico)[Electrochemical oxidation of DBT and DBTO₂ on Ti/Ir_{1-x}Sn_xO₂ and Pt electrodes](#)

s11-018

Güray Emir (Environmental Engineering, Anadolu University, Eskişehir, Turkey), Yusuf Yavuz[Impact Evaluation of Supporting Electrolyte Concentration on Ceramic Industry Wastewater Treatment by Iron Electrocoagulation](#)

s11-019

Ana S. Fajardo (Department of Chemical Engineering, University of Coimbra, Coimbra, Portugal), Helga F. Seca, Rui C. Martins, Rosa M. Quinta-Ferreira

[Phenolic wastewaters depuration by electrochemical oxidation process using Ti/RuO₂ anode](#)

s11-020

Ana S. Fajardo (Department of Chemical Engineering, University of Coimbra, Coimbra, Portugal), Rui C. Martins, Carlos Alberto Martinez-Huitle, Djalma R. da Silva, Rosa M. Quinta-Ferreira

[Reactive Black 5 dye elimination by using aluminum -batch and -flow electrocoagulation systems](#)

s11-021

Sergi Garcia-Segura (Instituto de Química, Universidade Federal do Rio Grande do Norte, Natal, Brazil), Sergi Garcia-Segura, Aleksandro Jhones dos Santos, Maycon Douglas de Lima, Djalma R. da Silva, Carlos Alberto Martinez-Huitle

[Influence of the Water Hardness on the Electro-Fenton Performance: Decolorization and Mineralization of Eriochrome Black T](#)

s11-022

Sergi Garcia-Segura (Instituto de Química, Universidade Federal do Rio Grande do Norte, Natal, Brazil), Sergi Garcia-Segura, Edilson do Vale-Júnior, Sergi Dosta, Irene Garcia Cano, Josep Maria Guilemany, Jailson Vieira de Melo, Carlos Alberto Martinez-Huitle

[Sn-Cu-Sb Alloy Anode Synthesized by Cold Gas Spray Applied on Azo Dye Decolorization](#)

s11-023

Elena Gorbachuk (Laboratory of organometallic and coordination compounds, A.E. Arbuzov Institute of Organic and Physical Chemistry, Kazan, Russia)

[First example of electrochemical synthesis of mono- and bis-\(alpha-oxalkyl\)phosphine oxides from white phosphorus via phosphine oxide H₃PO](#)

s11-024

Karine Groenen Serrano (Laboratoire de Génie Chimique, University Paul Sabatier, Toulouse, France), Pohere Chong, Fabien Chauvet, André Savall

[Investigations on the process of electrochemical removal of calcium carbonate in potable water](#)

s11-025

Bjorn Hasa (Chemical Engineering, University of Patras, Patras, Greece), Bjorn Hasa, Michalis Athanasiou, John Vakros, Alexandros Katsaounis, Constantinos Vayenas

[Electrochemical promotion of hydrogen oxidation on Pt/C in aqueous alkaline media.](#)

s11-026

Cheng-En Ho (Chemical Engineering & Materials Science, Yuan Ze University, Taoyuan City, Taiwan), Cheng-En Ho, Yu-Wei Lee, Chang-Chih Chen, Ying-Syuan Wu

[Effect of Brightener Concentration on Recrystallization Process of Electroplated Cu](#)

s11-027

François Lapique (Lab. Reactions and Chemical Engineering, Univ-Lorraine / CNRS, Nancy, France)

[Zinc removal from urban and natural waters: electrocoagulation or precipitation upon alkali addition?](#)

s11-028

Carlos Alberto Martinez-Huitle (Federal University of Rio Grande do Norte, Campus Universitário, Lagoa N, Natal, Brazil), Jessica Pires de Paiva Barreto, Karla Caroline de Freitas Araujo, Izabelle Cristina da Costa Soares, Amison Rick Lopes da Silva, Danyelle Medeiros de Araujo

[Electrochemical Oxidation of Acid Violet 7 by using Boron Doped Diamond Electrodes with Low and High Diamond Content](#)

s11-029

Andrea Massa (Department of Applied Science and Technology, Politecnico di Torino, Torino, Italy), Simelys Hernandez, Andrea Lamberti, Nunzio Russo, Candido F. Pirri, Debora Fino

[Electro-Oxidation of Phenol by Electrodeposited Manganese Oxides over Titanium and TiO₂ Nanotubes](#)

s11-030

Naoto Morita (Green Hydrogen Research Center, Yokohama National University, Yokohama, Japan), Yuki Sawaguchi, Kensaku Nagasawa, Yuji Kohno, Koichi Matsuzawa, Akihiro Kato, Yoshinori Nishiki, Shigenori Mitsushima

[Structure of Oxygen Evolution Anode for Toluene Electrohydrogenation Electrolysis](#)

s11-031

Martin Paidar (Department of Inorganic Technology, University of Chemistry and Technology Prague, Prague, Czech Republic), Martin Roubalik

[Electrochemical alkalization of wastewater for ammonia removal](#)

s11-032

Danny Pauwels (Faculty of Applied Engineering, University of Antwerp, Wilrijk, Belgium), Jonas Hereijgers, Kristof Verhulst, Karolien De Wael, Tom Breugelmans

[Investigation of the electrosynthetic pathway of the aldol condensation of acetone](#)

s11-033

Gbenga Peleyeju (Department of Applied Chemistry, University of Johannesburg, Johannesburg, South Africa), Omotayo Arotiba, Oyebamiji Babalola

[Oxidation of sulfamethoxazole at a carbon-titania electrode in a photoelectrochemical reactor](#)

s11-034

Valentín Pérez-Herranz (Department of Chemical and Nuclear Engineering, Universitat Politècnica de València, Valencia, Spain), Salatiel W. da Silva, Emma M. Ortega, Montserrat García-Gabaldón, Andréa M. Bernardes

[Removal of the Antibiotic Norfloxacin by Electrochemical Advanced Oxidation Processes](#)

s11-035

Mario Rosales (Ingeniería Geomática e Hidráulica, Universidad de Guanajuato, Guanajuato, Mexico), Mario Rosales, José L. Nava

[Computational fluid dynamic simulations of hydrodynamics of two phase flow in a novel electrocoagulation flow cell](#)

s11-036

Luis Ruotolo (Chemical Engineering, Federal University of Sao Carlos, Sao Carlos, Brazil), Rosimeire Farinos

[Comparison of BDD and RVC/PbO₂ Anodes for Organic Degradation](#)

s11-037

Staffan Sandin (Applied Electrochemistry, Chemical Science and Engineering, KTH, Royal Institute of Technology, Stockholm, Sweden), Ann Cornell, Joakim Bäckström

[Comparison of tin source for preparation of Sb and Ni doped SnO₂ electrodes for ozone formation](#)

s11-038

Elisama Santos (School of Science and Technology, Federal University of Rio Grande do Norte, Natal, Brazil), Cristina Sáez, Pablo Cañizares, Carlos Alberto Martinez-Huitle, Manuel Andres Rodrigo

[Coupling of soil washing and electro-irradiated technologies for the remediation of polluted with petroleum](#)

s11-039

Laura Sanz (Electrochemical Storage and Energy Harvesting, Catalonia Institute for Energy Research, Barcelona, Spain), Cristina Flox, Jordi Jacas Biendicho, Javier Vázquez-Galván, Joan Ramon Morante

[Improvements in Stack Development for All-Vanadium Redox Flow Batteries](#)

s11-040

Onofrio Scialdone (Dipartimento di Ingegneria Chimica, Gestionale, Informatica, Università di Palermo, Palermo, Italy), Adriana D'Angelo, Alessandro Galia, Fabrizio Vicari

[Electrochemical abatement of pollutants in reverse electrodialysis and microbial reverse electrodialysis stacks](#)

s11-041

Everson Silva (Department of Analytical Chemistry, Institute of Chemistry, State University of Campinas - UNICAMP, Campinas, Brazil), Lauro Kubota, Vitória Morais

[Toner printing as a versatile tool for the fabrication of microelectrodes and microarray](#)

s11-042

Cristina Sáez (Chemical Engineering, University of Castilla La Mancha, Ciudad Real, Spain), José Fernando Pérez, Javier Llanos, Cristina Sáez, Conrado López, Pablo Cañizares, Manuel A. Rodrigo, Salvador Cotillas

[Treatment of Real Pharmaceutical Effluents: Electro-oxidation vs. Fenton Oxidation](#)

s11-043

Abdoulaye Thiam (Química de los Materiales, Universidad de Santiago de Chile, Santiago, Chile), Ricardo Salazar

[Degradation and mineralization of Metolachlor by electrochemical advanced oxidation processes using Platinum or Boron-Doped Diamond anode](#)

s11-044

Jorge Vidal (Departamento Química de los Materiales, Universidad de Santiago de Chile, Santiago, Chile), Ricardo Salazar, Cesar Huiliñir, Ricardo Torres

[Degradation of ampicillin sodium from water by photoelectron-Fenton](#)

s11-045

Paul-Augustin Wasner (Electronics - Plating through holes, Atotech Deutschland GmbH, Berlin, Germany), Roman-David Zimmermann, Edith Steinhäuser, Lutz Stamp, Frank Brüning, Constanze Donner, Nicole Fréty, Eric Anglaret

[Electrochemical Monitoring of N,N'-diethylthiourea in Electroless Copper Electrolytes by Linear Sweep Voltammetry](#)

s11-046

Xiaoyin Xiao (Department of Biosensors and Nanomaterials, Sandia National Labs, Albuquerque, USA), Ping Lu, Arthur Fischer, Benjamin Leung, Michael Coltrin, George Wang, Jeffrey Tsao

[Chemical Interference of Quantum Size Controlled Photoelectrochemical Fabrication](#)

s11-047

Ridha Zerdoumi (Department of Chemistry, University of Biskra, Biskra, Algeria), Hadjer Chatta, Mahmoud Ferhat, Kafia Oulmi, Dhaouadi Mellahi

[Chronopotentiometric Evaluation of Enhanced Counter-ion Transport through Anion Exchange Membranes](#)

Sustainable production of valuable compounds

s11-048

Tim Albrecht (Department of Chemistry, Imperial College London, London, United Kingdom), Daniel Godfrey, James Bannock, Olga Kuzmina, Tom Welton

[A robotic platform for high-throughput electrochemical analysis of chalcopyrite leaching](#)

s11-049

José M. Bisang (PRELINE, Facultad de Ingeniería Química, Universidad Nacional del Litoral, Santa Fe, Argentina), Juan Pablo Fornés

[Cathodic Depassivation by Increasing the Temperature in the Production of Colloidal Sulphur by Sulphur Dioxide Reduction](#)

s11-050

Christoph Gütz (Institute of Organic Chemistry, Johannes Gutenberg University Mainz, Mainz, Germany), Maximilian Selt, Markus Bänziger, Christoph Bucher, Christina Römelt, Nadine Hecken, Fabrice Gallou, Tomás, R. Galvão, Siegfried Waldvogel

[Novel Cathode Material for Electrochemical Reductions](#)

s11-051

Robert Harris (Chemistry, University of Leicester, Leicester, United Kingdom), Karl S. Ryder

[Aluminium Plating Process for Cadmium Replacement from Ionic Liquids \(AIPCaR\)](#)

s11-052

Maximilian Selt (Institute of Organic Chemistry, Johannes Gutenberg University Mainz, Mainz, Germany), Thomas Quell, Stamo Mentizi, Katrin M. Dyballa, Robert Franke, Siegfried Waldvogel

[Electrosynthesis of 3,3',5,5'-Tetramethyl-2,2'-biphenol](#)

s11-053

Nina Simic (Process RD&I, AkzoNobel Pulp and Performance Chemicals, Bohus, Sweden), Katerina Minhová Macounová, Petr Krtil, Elisabet Ahlberg

[Reaction mechanism of hypochlorite oxidation on RuO₂ and doped RuO₂ electrodes - A DEMS approach](#)

s11-054

Yoshitsugu Sone (Institute of Space and Astronautical Science, Japan Aerospace Exploration Agency, 3-1-1 Yoshinodai, Chuo-ku, Sagamihara, Japan), Kazutaka Sato, Omar S. Mendoza-Hernandez, Sayoko Shironita, Asuka Shima, Minoru Umeda

[Electrochemical Reduction of CO₂ at CO₂-H₂ Fuel Cell Cathode](#)

s11-055

Eseoghene Umukoro (Department of Applied Chemistry, University of Johannesburg, Johannesburg, South Africa), Moses Peleyeju, Jane Ngila, Omotayo Arotiba

[Electrochemical and Photo-assisted Electrochemical Oxidation of Organic Pollutants in Waste Water at Novel Tungsten Trioxide-Exfoliated Graphite Composite Electrode](#)

s11-056

Lin Zhang (LCPME, CNRS / Université de Lorraine, Villers-lès-Nancy, France), Neus Vila, Gert Kohring, Alain Walcarius, Mathieu Eienne

[Co-immobilization of \[Cp^{*}Rh\(bpy\)Cl\]⁺ and NAD-dependent Dehydrogenases in Electrochemical Bioreactors for Enantioselective Bioconversion Experiments](#)

s11-057

Carolina Espinoza (Química de los Materiales, Universidad de Santiago de Chile, Santiago, Chile), Ricardo Salazar, Carlos Alberto Martínez-Huitle

[Electrochemical oxidation of dye Acid Red 1 using boron doped diamond electrodes with different ratio sp³/sp²](#)

Symposium 12 EC Power Sources: Principles of Materials, Design and Operation

Design

s12-001

Yi-Lin Chen (Chemical Engineering, National Taiwan University, Taipei, Taiwan), Miao-Syuan Fan, Yi-June Huang, Kuo-Chuan Ho

[Flower-Like Phosphorus-Doped Nickel Oxide as Low-Cost Counter Electrode for Dye-Sensitized Solar Cells](#)

s12-002

Rodrigo Henríquez (Instituto de Química, Pontificia Universidad Católica de Valparaíso, Valparaíso, Chile)

[Synthesis and characterization of FeS₂ obtained by inverse micelles method.](#)

Durability

s12-003

Kenji Matsumae (Engineering, Yokohama National University, Yokohama, Japan), Kensaku Nagasawa, Yuji Kohno, Koichi Matsuzawa, Akihiro Kato, Yoshinori Nishiki, Shigenori Mitsushima

[Durability of IrO₂ anode for O₂ evolution with toluene contamination](#)

s12-004

Anish Pokhrel (Fuel Cell Research Lab (FCReL), Mechatronics Engineering, Simon Fraser University, Surrey, Canada), Mohamed Hannach, Frank Orfino, Monica Dutta, Erik Kjeang

[D Catalyst Layer Degradation Analysis using X-ray Computed Tomography](#)

Engineering

s12-005

Yi-June Huang (Chemical Engineering, National Taiwan University, Taipei, Taiwan), Chuan-Pei Lee, Miao-Syuan Fan, Chun-Ting Li, R. Vittal, Kuo-Chuan Ho

[Pencil-urchin-like Structure of Cobalt Diselenide Catalytic Film as Counter Electrodes for Dye-Sensitized Solar Cells](#)

s12-006

Boram Koo (Department of Energy Systems Research, Ajou University, Suwon, Korea), Jaeshin Yi, Chee Burm Shin

[Thermal modeling of a lithium-ion battery pack for electric vehicle applications](#)

s12-007

Ilbok Lee (School of Integrative Engineering, Chung-Ang University, Seoul, Korea), Gyoung Hwa Jeong, Sang-Wook Kim, Jaekwang Kim, Songhun Yoon

[Cobalt Vanadate Nanorods on Graphene Sheets and Their Application as High-Performance Anode Materials for Li-ion batteries](#)

s12-008

Sung June Park (Department of Energy Systems Research, Ajou University, Suwon, Korea), Jaeshin Yi, Chee Burm Shin, Jongrak Choi, Ha-Young Lee

[Thermal modeling of an ultracapacitor module comprising 136 cells and comparison with experimental data](#)

Performance

s12-009

Andrea Cerdán Pasarán (Chemical engineering, Universidad de Guanajuato, GUANAJUATO, Mexico), Ana Sánchez-Solís, Isaac Zarazúa, Tzarara López-Luke, Rosalba Fuentes-Ramírez, Alejandro Alatorre-Ordaz, Diego Esparza, Elder De la Rosa

[Impedance Analysis of CdSe Multilayered Quantum Dot Sensitized Solar Cell](#)

s12-010

Martin Prokop (Department of Inorganic Technology, UCT Prague, Prague, Czech Republic), Tomas Bystron, Petr Belsky, Karel Bouzek

[Increase in Size of Pt Nanoparticles during High Temperature PEM Fuel Cell Operation Studied by Post-mortem Analysis](#)

Power sources

s12-011

Jaekwang Kim (Integrative Engineering, Chung-Ang University, Seoul, Korea), Eunok Kim, Ilbok Lee, Songhun Yoon

[Non-disruptive in-situ Raman Analysis for Gas Evolution in Commercial Supercapacitor Cell](#)

s12-012

Burak Ulgut (Chemistry, Bilkent University, Ankara, Turkey)

[Correlation of Battery Voltage Noise to the SOH of Batteries](#)

s12-013

Qinghong Zhang (College of Materials and Engineering, Donghua University, Shanghai, China)

[Ti-based Flexible Dye-Sensitized Solar Cells with Titanium Oxide Nanotube Array as an Interfacial Layer](#)

Symposium 13 Corrosion: The Electrochemistry of Corrosion and Approaches to Corrosion Protection

Coatings

s13-001

Mario Aparicio (Institute of Ceramic and Glass, CSIC, Madrid, Spain), A. Jitianu, G. Rodriguez, A. Degnah, K. Al-Marzoki, Jadra Mosa, L.C. Klein

[Low-thickness organic-inorganic melting-gel coatings for protection of 304 Stainless Steel in NaCl solutions](#)

s13-002

Miguel A. Domínguez-Crespo (CIAMS, Instituto Politecnico Nacional/CICATA Unidad Altamira, ALTAMIRA, Mexico), Aide M. Torres-Huerta, Edgar Onofre-Bustamante, Abigail Alanís-Valdelamar, María L. Escudero-Rincón, Silvia B. Brachetti-Sibaja

[Corrosion studies of PPy/Ni organic-inorganic hybrid bilayer coatings on commercial carbon steel](#)

s13-003

Pei-Tzu Lee (Chemical Engineering & Materials Science, Yuan Ze University, Taoyuan City, Taiwan), Ying-Syuan Wu, Chang-Chih Chen, Yu-Wei Lee, Cheng-En Ho

[High-speed Cu Electrodeposition and Its Adhesion](#)

s13-004

Artur Maciej (Faculty of Chemistry, Silesian University of Technology, Gliwice, Poland), Artur Wadas, Robert Socha, Joanna Michalska, Maciej Sowa, Wojciech Simka

[Anodic Oxidation of Zn-based Galvanic Coatings in Alcoholic Solutions](#)

s13-005

Markus J. Spallek (Surface Technology & Protection, Electrochemistry, Research Institute for Materials, Fuels and Lubricants Bw, Erding, Germany), Markus J. Spallek, Felix Künzel, Burt Neumann, Gerlinde Brandenburg

[REACH conform Surface Protection for Vehicle Construction Alumina – Corrosion Protection and Chemical Coating Compatibility](#)

s13-006

Jorge O. Zerbino (Electrochemistry, Instituto de Inv. Fisicoquímicas, INIFTA, La Plata, Argentina), Cecilia Deya, Cecilia I. Elsner, Alejandro R. Di Sarli

[Electrochemical and Optical Properties of Silane Layers Grown on Anodized Zinc](#)

s13-007

Jifu Zhang (Thermal spray department, Guangdong Institute of New Materials, Guangzhou, China)

[Electrochemical corrosion behavior of Iron-Based Amorphous coating prepared by HVOF](#)

s13-008

Qingjun Zhu (Institute of Oceanology, Chinese Academy of Sciences, Qingdao, China)

[Synthesis & Corrosion properties of arc spray Zn-25Al coating](#)

Corrosion

s13-010

Paulo Casciano (Chemical Analytical and Physical Chemistry, Federal University of Ceara, Fortaleza, Brazil), Archimedes Junior, Diego F. Dias, Adriana Correia, Pedro Lima-Neto

[Corrosion study of maraging steel grade 300 in NaCl aqueous medium saturated with CO₂](#)

s13-011

Sandrine Costenoble (DRCP/SERA/LED, CEA Marcoule, Bagnols sur Cèze, France), Claire Laluc, Beatriz Puga

[Corrosion Studies on Austenitic Stainless Uranus S1N steels under Nuclear Fuel Dissolution Conditions](#)

s13-012

Miguel A. Domínguez-Crespo (CIAMS, Instituto Politecnico Nacional, CICATA Unidad Altamira, ALTAMIRA, Mexico), Ana B López-Oyama, Aide M. Torres-Huerta, Edgar Onofre-Bustamante

[Green electrochemical alternative to obtain reduced graphene oxide by pulse potential: Effect of synthesis parameters and study of corrosion properties](#)

s13-013

Silviu Iulian Drob (Electrochemistry and Corrosion, Institute of Physical Chemistry Ilie Murgulescu, Bucharest, Romania), Cora Vasilescu, Mihai Andrei, Petre Osiceanu, Jose Maria Calderon Moreno, Ioana Demetrescu, Monica Popa

[Corrosion Resistance of a New Dental CoCr Alloy with Nb, Mo and Zr](#)

s13-014

Samuel Leleu (Cirimat, INPT, France, France), Nadine Pebere, Bertrand Rives

[Investigation of the corrosion behaviour of magnesium alloys by electrochemical impedance spectroscopy \(EIS\)](#)

s13-015

Hiroyuki Saito (Engineering, Tokyo Denki University, Tokyo, Japan), Hiroyuki Saito, Motoaki Osawa, Moritsugu Fuse, Kazuaki Aoshima, Masao Uyama

[Electrochemical study of carbon steel corrosion in bentonite](#)

s13-016

Patrik Schmuki (Materials Science, University of Erlangen- Nuremberg, Erlangen, Germany)

[Critical factors in TiO₂ nanotube growth](#)

s13-017

Beatriz Valcarce (Division Corrosion y Electroquímica, INTEMA, UNMdP, Mar del Plata, Argentina)

[The effect of citrate ions on the stability of passive film on carbon steel in alkaline solution contaminated with chloride ions](#)

s13-018

Jie Zhang (Key Laboratory of Marine Environmental Corrosion and Bio-fou, Institute of Oceanology, Chinese Academy of Sciences, Qingdao, China), Jiangwei Wang, Shougang Chen, Jizhou Duan

[The action of biofouling and calcareous deposit on the corrosion of carbon steel](#)

s13-019

Bo Zhao (Material Research Office, China Special Equipment Inspection and Research Institute, Beijing, China), Zhiyong Liu, Cuiwei Du, Xiaogang Li, Binan Shou

[Study on Stress Corrosion Crack Susceptibility of X80 Steel under the Disbanding Coating](#)

Corrosion protection

s13-020

Ekatarina Kristan Mioc (Faculty of chemical engineering and technology, University of Zagreb, Zagreb, Croatia), Ekatarina Kristan Mioc, Zana Hajdari, Helena Otmacic Curkovic, Saman Hosseinpour

[The Influence of Solvent on Properties of Self-assembled Monolayers of Stearic Acid](#)

s13-021

Cylia Oulmas (Chemistry, University Mouloud Mammeri de Tizi-Ouzou, Tizi-Ouzou, Algeria), Dalila Boughrara, Slimane Boutarfaia, Abdelaziz Kadri, Nassima Benbrahim

[Marine Corrosion Protection with AlZnSnIn Sacrificial Anodes](#)

s13-022

Nelson Vejar (Escuela de Construcción Civil, Pontificia Universidad Católica de Chile, Santiago, Chile), Diego Alvarado, Pablo Figueroa, Claudia Alvarado, Carlos Galarce, José Donoso, Maritza Paez, Mamié Sancy

[Capsaicin Enhanced D-aminoacids as a Biofilms and Influence Corrosion Mitigation of 7075-T6 by Strain *Bacillus megaterium*](#)

s13-023

Lewis Yule (Department of Chemistry, University of Warwick, Coventry, United Kingdom), Patrick Unwin, Barbara Shollock, Geoff West

[A multimicroscopy approach to relate microstructural features to the electrochemical activity of steel](#)

In situ/in operando characterization

s13-024

Kei Murakoshi (Department of Chemistry, Hokkaido University, Sapporo, Japan), Shunpei Oikawa, Atsuyori Ohnuki, Satoshi Yasuda, Hiro Minamimoto

[Precise Control of Plasmon-Active Au Nano-Structures using Electrochemical Method](#)

Inhibitors

s13-025

Rong-Gui Du (Department of Chemistry, Xiamen University, Xiamen, China), Ying-Bo Gao, Hai-Peng Wang, Juan Hu, Zi-Chao Guan

[Inhibition Effect of Phytic Acid on Reinforcing Steel in Simulated Concrete Pore Solutions](#)

s13-026

Helena Otmacic Curkovic (Faculty of Chemical Engineering and Technology, University of Zagreb, Zagreb, Croatia), Franjo Ivusic, Olga Lahodny-Sarc, Vesna Alar, Ivan Stojanovic

[Corrosion Protection of Carbon Steel in Seawater by Cerium Chloride](#)

s13-027

Cylia Oulmas (Chimie, University Mouloud Mammeri, Tizi-Ouzou, Algeria), Lamia Allam, Abdelaziz Kadri

[Clove oil as a Green Corrosion Inhibitor for Carbon Steel in Hydrochloric Acid](#)

Symposium 14 Combined Electro and Electrophoretic Deposition for Advanced Materials Synthesis

Coatings

s14-001

Jeng-Yu Lin (Department of Chemical Engineering, Tatung University, Taipei City, Taiwan), Yaoming Xiao, Gaoyi Han, Yunzhen Chang, Ying Zhang, Hsiao-Shan Peng

[Bifacial perovskite solar cell based on electropolymerized PEDOT functioning as the p-type hole-transporting material and synergistic sensitizer](#)

Electrodeposition

s14-002

Liana Anicai (Center for Surface Science and Nanotechnology, University Politehnica of Bucharest, Bucharest, Romania), Anca Cojocaru, Ion Sin, Adina Cotarta, Marius Enachescu, Teodor Visan

[Electrodeposition of Lead Telluride and Selenide Films from Ionic Liquids Based on Choline Chloride](#)

s14-003

Liana Anicai (Center of Surface Science and Nanotechnology, University Politehnica of Bucharest, Bucharest, Romania), Stefania Costovici, Oana Brancoveanu, Aida Ghiulnare Apaz, Teodor Visan

[The Influence of Plating Conditions on Electrodeposition Process of Binary Co-Mo Alloy Coatings Involving Ionic Liquids Analogues](#)

s14-004

Andrew Ballantyne (Chemistry, University of Leicester, Leicester, United Kingdom), Andrew P. Abbott, Robert Harris, Jamil Juma, Karl S. Ryder

[The Effect of Organic Additives in Electrodeposition of Ni from Deep Eutectic Solvents](#)

s14-005

Kun Chen (Chemistry, Monash University, Melbourne, Australia), Douglas MacFarlane, Xinyi Zhang

[Cu-based Ordered Nanomaterials for CO₂ Reduction and Surface-enhanced Raman Spectroscopy](#)

s14-006

Chang-Chih Chen (Chemical Engineering & Materials Science, Yuan Ze University, Taoyuan, Taiwan),
Cheng-En Ho, Chang-Chih Chen, Hung-Cheng Liu, Cheng-Hsien Yang

[Direct Proof of the Pinhole Formation Mechanism in Electroplated Cu Films](#)

s14-007

Pedro De Lima-Neto (Analytical Chemistry and Physical Chemistry, Federal University of Ceara, Fortaleza, Brazil), Adriana Correia, Ana Aline C. Alcanfor, Luis P. M. Dos Santos, Diego F. Dias

[Study of Indium Electrodeposition on Copper Surface From Choline Chloride/Ethylene Glycol Eutectic Mixture](#)

s14-008

Cédric Frantz (Laboratory for Mechanics of Materials and Nanostructures, Empa, Thun, Switzerland),
Yucheng Zhang, Johann Michler, Laetitia Philippe

[Electrodeposition of PbTe: from the electrochemical behavior to the electrodeposition of nanostructures](#)

s14-009

Run Liu (Department of Chemistry, Zhejiang University, Hangzhou, China), Qinyan Lu, Kedan Lu, Jianying Gong

[Room Temperature Electrodeposition of AgCuO₂ Films for Electrocatalytic Water Oxidation](#)

s14-010

Monika Lukaczynska (Materials and Chemistry, Vrije Universiteit Brussel, Brussel, Belgium), Jon Ustarroz, Herman Terryn

[Electrodeposition of Ni coatings on low carbon steel from choline chloride based Deep Eutectic Solvents](#)

s14-011

Hiroshi Matsubara (General Education, Nagaoka University of Technology, Nagaoka, Japan), Shogo Samejima, Kazunori Hodouchi, Kouichi Kudou

[Effect of Amino Acid Additives on the Hardness of Fe plated films](#)

s14-012

Quentin Rayée (Faculté des Sciences, Université libre de Bruxelles, Bruxelles, Belgium), Claudine Buess-Herman, Thomas Doneux

[Silver electrodeposition on gold from a choline chloride - urea electrolyte](#)

s14-013

Samuel Jaeho Shin (Chemistry, Seoul National University, Seoul, Korea), Jin-Young Lee, Jae Gyeong Lee, Sunmi Lee

[Electrodeposition of Metal Nanoparticles Directly on Dielectric Electrode and Its Application for Hydrogen Gas Sensor](#)

s14-014

Cheng-Hsien Yang (Chemical Engineering & Materials Science, Yuan Ze University, Taoyuan City, Taiwan), Yu-Wei Lee, Chang-Chih Chen, Cheng-En Ho

[Self-annealing Behavior of Electroplated Cu in the Blind-hole Structure](#)

Electrophoresis/ Electrophoretic Deposition

s14-015

Aldo Boccaccini (Institute of Biomaterials, University of Erlangen-Nuremberg, Erlangen, Germany), Sigrid Seuss

[Electrophoretic and electrodeposition in biofabrication approaches](#)

s14-016

Zoilo Gonzalez (Ceramic, Institute for Ceramic and Glass.CSIC, Madrid, Spain), Claudine Filiâtre, Antonio Javier Sanchez-Herencia, Begoña Ferrari

[Study of the EPD of Ni\(OH\)₂ nanoplatelets based on their surface modification through LbL deposition of polyelectrolytes](#)

s14-017

Svenja Heise (Materials Science and Engineering - Biomaterials, University of Erlangen-Nuremberg, Erlangen, Germany), Michael Höhlinger, Victoria Wagener, Helga Hornberger, Sannakaisa Virtanen, Aldo Boccaccini

[Development of a biodegradable natural polymer/bioactive glass coating for Mg alloys using electrophoretic deposition](#)

Symposium 15 New Molecules - Synthesis, Fundamental Electron Transfer Properties and their Relationship with Molecular Action

Electrosynthesis

s15-001

Belen Batanero (Organic Chemistry, University of Alcalá, Alcalá de Henares (Madrid), Spain)

[Electrosynthesis of 1,3-Dioxoles by Homogeneous Electron-Transfer](#)

s15-002

Isabella Chiarotto (SBAI, Sapienza University of Rome, Rome, Italy), Francesca D'Anna, Marta Feroci, Fabrizio Gala, Achille Inesi, Renato Noto, Luigi Ornano, Giuseppe Zollo

[N-Heterocyclic Carbenes \(NHCs\) from Imidazolium, Triazolium, Thiazolium Salts: Nucleophilicity, Basicity, Stability Indications from Cyclic Voltammetry and Ab-Initio Calculations](#)

s15-003

Marta Feroci (Scienze di Base e Applicate per l'Ingegneria, Sapienza University of Rome, Rome, Italy), Isabella Chiarotto, Luigi Ornano

[Electrogenerated Superoxide Anion: Benzamides from Deoxybenzoin and Amines](#)

s15-004

Armando Gennaro (Department of Chemical Sciences, University of Padova, Padova, Italy), Francesco De Bon, Abdirisak A. Isse

[Electrochemically Mediated Atom Transfer Radical Polymerization of Methyl Acrylate in Ionic Liquids](#)

s15-005

Vitali Grinberg (Processes in Batteries, Frumkin Institute of Physical Chemistry and Electrochemistry, Moscow, Russia), Natalia Mayorova, Eugene Maevsky, Sergey Sterlin

[Dibromopolyoxafluoroalkanes as new materials for biomedical applications](#)

s15-006

Turan Gul (Analytical Biochemistry, Groningen University, Groningen, Netherlands), Rainer Bischoff, Hjalmar Permentier

[Synthesis of Aromatic Hydroxylation Metabolites of Lidocaine by Using a Pt-oxide surface](#)

s15-007

Abdirisak A. Isse (Department of Chemical Sciences, University of Padova, Padova, Italy), Francesca Lorandi, Marco Fantin, Armando Fantin

[Cathodic Materials for Electrochemically Mediated Atom Transfer Radical Polymerization in Organic and Aqueous Media](#)

s15-008

Francesca Lorandi (Chemical Sciences, University of Padova, Padova, Italy), Marco Fantin, Abdirisak A. Isse, Armando Gennaro

[Poly\(acrylic acid\) via Electrochemically Mediated Atom Transfer Radical Polymerization](#)

s15-009

Francesca Lorandi (Chemical Sciences, University of Padova, Padova, Italy), Abdirisak A. Isse, Armando Gennaro

[Coupled Copper Cathode/Anode for Electrochemically Mediated Atom Transfer Radical Polymerization in Undivided Cells](#)

s15-010

Dominique Lucas (Institut de Chimie Moléculaire de l'Université de Bourgogne, Université de Bourgogne, Faculté des Sciences Mirande, Dijon, France), Charles H. Devillers, Seydou Hebié, Sébastien Rolle, Abdou Dimé, Olivier Heintz, Frédéric Herbst, Mikhail Vorotyntsev, Dmitry Konev

[Electrochemistry as an Attractive and Effective Tool for Synthesis and Immobilization of Porphyrins on Electrode Surfaces](#)

s15-011

Omar Martínez-Mora (Separation and Conversion Technologies, VITO – Flemish Institute for Technological Research, Mol, Belgium), Sunita Rajamani, Yolanda Alvarez Gallego, Xochitl Dominguez-Benetton

[Electrosynthesis of Ionic Liquids and their Evaluation as Catalysts for Crude Oil Hydroprocessing Reactions](#)

s15-012

Siegfried Waldvogel (Institute of Organic Chemistry, Johannes Gutenberg University, Mainz, Germany)

[Metal- and Reagent-free Anodic Cross-Coupling of Arenes](#)

s15-013

Cheng-Chu Zeng (College of Life Science & Bioengineering, Beijing University of Technology, Beijing, China), Li-Shuo Kang, R. Daniel Little

[Electrochemical C-H Functionalization and Subsequent C-S and C-N Bond Formation: Paired Electrosynthesis of 3-Amino-2-thiocyanato Carbonyl Derivatives Mediated by Bromide Ion](#)

Multiple redox centers

s15-014

Irena Hoskovicová (Inorganic Chemistry, University of Chemistry and Technology Prague, Prague, Czech Republic), Radka Metelková, Hana Váňová, Tomáš Fobrmann, Jiří Ludvík

[Redox Properties of Fischer Carbene Complexes with Two Chromium Centers](#)

s15-015

Corinne Lagrost (Institut des Sciences Chimiques de Rennes, CNRS and University of Rennes 1, RENNES, France), Andrea Mulas, Yves-Marie Hervault, Lucie Norel, Stéphane Rigaut

[Electron Transfer Kinetics in Polymetallic carbon-rich Ruthenium\(II\) bis\(\$\sigma\$ -arylacetylides\) Wires Connected to Gold](#)

s15-016

Ludmila Simková (Molecular electrochemistry, J. Heyrovský Institute of Physical Chemistry of the ASCR, Prague, Czech Republic), Jirí Ludvík

[Redox Properties of New Energetic Material 2,2-dinitroethene-1,1-diamine \(FOX-7\), a Molecule of the Push-pull Type with Multiple Redox Centres](#)

Organic and bio-organic molecules

s15-017

Elene Kvaratskhelia (R. Agladze Institute of Inorganic and Electrochemistry, Iv. Javakhishvili Tbilisi State University, Tbilisi, Georgia), Elene Kvaratskhelia, Rusudan Kurtanidze

[The Electrolytic Dissociation of Methyl Derivatives of Succinic Acids](#)

s15-018

Tatiana Magdesieva (Chemistry Department, Leninskie Gory, 1/3, Moscow, Russia), Oleg Levitskiy

[Tert-Butyl Substituted Diphenylnitroxides as Perspective Candidates for Ambipolar Redox Active Materials](#)

s15-019

Goswinus de Kruijff (Institute of Organic Chemistry, Johannes-Gutenberg University, Mainz, Germany), Siegfried Waldvogel

[Anodic Decarboxylation of \$\alpha\$ -Tertiary Diterpenoid Carboxylic Acids](#)

Organometallic and coordination compounds

s15-020

Georgiana-Luiza Arnold (Inorganic Chemistry, Physical Chemistry and Electrochemistry, University Politehnica of Bucharest, Bucharest, Romania), Eleonora-Mihaela Ungureanu, George-Octavian Buica, Ioana-Georgiana Lazar, Liviu Birzan

[Modified Electrodes based on 2-thioxo-5-\(\(4,6,8-trimethylazulen-1-yl\)methylen\)imidazolidin-4-one for Heavy Metal Ions Detection](#)

s15-021

Malgorzata Frik (Faculty of Chemistry, University of Warsaw, Warsaw, Poland), Pawel J. Kulesza

[Synthesis, Physicochemical Identity and Electrocatalytic Properties of New Organometallic Molecules](#)

s15-022

Konstantin Kottrup (Leiden Institute of Chemistry, Leiden University, Leiden, Netherlands)

[Iron-based Electrocatalysts for the Water Oxidation Reaction](#)

s15-023

Daisuke Motoyama (Department of Applied Chemistry, Chuo University, 1-13-27 Kasuga, Bunkyo-ku, Japan), Kai Yoshikawa, Hiroaki Ozawa, Masa-aki Haga, Hiroaki Ozawa

[Energy Storage by Proton-coupled Electron Transfer Reactions of Ru Complexes Bearing Benzimidazole Ligands in Aqueous Solution](#)

s15-024

Anna Wadas (Faculty of Chemistry, University of Warsaw, Warszawa, Poland), Adam Gorczyński, Iwona A. Rutkowska, Pawel J. Kulesza, Maciej Kubicki, Violetta Patroniak

[Electrocatalytic Reductions of Carbon Dioxide and Oxygen at Network Films of Transition Metal Complexes](#)

s15-025

Lucy Wilson (Department of chemistry, Imperial College London, London, United Kingdom), Michael Inkpen, Nicholas Long, Tim Albrecht

[Unique and Complex Systems with Multiple Redox Active Centres for Molecular Electronics](#)

s15-026

Martijn van der Plas (Leiden Institute of Chemistry, Leiden University, Leiden, Netherlands), Dennis Hetterscheid, Elisabeth Bouwman, Marc Koper

[Electrocatalytic CO₂ reduction in neutral aqueous media on a modified carbon electrode](#)

Other

s15-027

Yamei Li (Biofunctional Catalyst Research Team, CSRS, Riken, Japan, wako, Japan), Ryuhei Nakamura
Molybdenum Disulfide: Concerted Proton Electron Transfer and its involvement in Nitrate Reduction

Quantum chemical calculations

s15-028

Paulino Zeron (Facultad de Química, Universidad Nacional Autónoma de México, Mexico City, Mexico), Víctor-Manuel Ugalde-Saldívar, Ignacio González

[Combined Computational and Experimental Studies of the Isolated Components of a Model Dye-Sensitized Solar Cell](#)

Reaction mechanisms

s15-029

Yuvraj Y. Birdja (Catalysis and Surface Chemistry, Leiden Institute of Chemistry, Leiden, Netherlands), Jing Shen, Marc Koper

[Electrocatalytic CO₂ reduction to Formic acid – Influence of the Metal center of Metalloprotoporphyrins](#)

s15-030

Alessandro Boni (Department of Chemistry, University of Bologna, Bologna, Italy), Giovanni Valenti, Ferdinand Hof, Alain Penicaud, Francesco Paolucci

[Graphite Intercalation Compounds as Effective Platforms for The Preparation of Highly-Active Electrocatalysts: The Case of ORR and CO₂ Reduction](#)

s15-031

Zhi-Xin Chen (iChEM, Xiamen University, Xiamen, China), Tao Wang, Zhi-Yong Chen, Tian Sheng, Yu-Hao Hong, Zi-Ang Nan, Jun Zhu, Zhi-You Zhou, Hai-Ping Xia, Shi-Gang Sun

[Substituent Modification on the Ligands Change Catalytic Reaction Mechanism of HER](#)

s15-032

Katrin F. Domke (Molecular Spectroscopy Department, MPI Polymer Research, Mainz, Germany)

[The electrochemical growth mechanism of CuBTC](#)

s15-033

Joel Donkeng Dazie (Department of Molecular Electrochemistry, J. Heyrovsk Institute of Physical Chemistry of the AS CR, Prague, Czech Republic), Jirí Ludvík

[Electrochemical and Spectrophotometric Study of Reactivity of Orthophthalaldehyde with Primary Amines and Diamines](#)

s15-034

Carlos Frontana (Investigacion, CIDETEQ, SC, Sanfandila, Pedro Escobedo, Mexico), Teresita Maldonado

[Intramolecular Hydrogen Bonding Influence in Self-Protonation of alpha-Hydroxyquinones](#)

s15-035

Evgeny Smirnov (SB ISIC LEPA, EPFL, Sion, Switzerland), Pekka Peljo, Hubert Girault

[Electron Transfer Reaction at Liquid-Liquid Interfaces: What is the Correct Mechanism?](#)

s15-036

Bart Vanrenterghem (Faculty of Applied Engineering, University of Antwerp, Wilrijk, Belgium), Tom Breugelmans

[The influence of solvation on the carbon-halogen bond rupture on rotating disk electrodes](#)

s15-037

Elena Villani (Department of Chemistry G. Ciamician, University of Bologna, Bologna, Italy), Giovanni Valenti, Enrico Rampazzo, Elisa Biavardi, Giulio Fracasso, Massimo Marcaccio, Federico Bertani, Dunia Ramarli, Enrico Dalcanale, Francesco Paolucci, Luca Prodi

[Sarcosine as Prostate Cancer Marker detected by Electrogenated Chemiluminescence](#)

s15-038

Jose H. Zagal (Chemistry of Materials, University of Santiago de Chile, Santiago, Chile), Jose H. Zagal, Marc Koper

[Reactivity descriptors for the electrocatalytic activity of MN₄ molecular catalysts for the dioxygen reduction reaction](#)

s15-039

Koen van der Ham (Leiden Institute of Chemistry, Leiden University, Leiden, Netherlands)

[Structural investigation on the activation of molecular Ir-based water oxidation catalysts](#)

Spectroelectrochemistry

s15-040

Wei Chen (Department of Chemical Physics, University of Science and Technology of China, Hefei, China), Yan-Xia Chen

[On the Accuracy in Quantitative Analysis of Electrocatalytic Reactions Using Differential Electrochemical Mass Spectrometry](#)

s15-041

Karol Luspai (Department of Physical Chemistry, FCHFT, Slovak university of technology in Bratislava, Bratislava, Slovakia), Daniela Keszeliová, Martin Barlog, Peter Rapta

[Transparent Boron-Doped Diamond Electrodes \(t-BDDE\) and their use in EPR/UV-VIS-NIR Spectroelectrochemistry](#)

s15-042

Peter Machata (Nanoscale Chemistry, Leibniz Institute for Solid State and Materials Research, Dresden, Germany), Michal Zalibera, Tyler T. Clikeman, Marco Rosenkranz, Steven H. Strauss, Eric V. Bukovsky, Olga V. Boltalina, Alexey Popov

[Spectroelectrochemical Studies of Perfluoroalkylated Derivatives of PAHs and Fullerenes](#)

Symposium 16 Physical and Interfacial Electrochemistry: Progress in Spectroscopy, Imaging and Theoretical Analysis

Electrocatalysis

s16-001

Elena Baranova (Department of Chemical and Biological Engineering, University of Ottawa, Ottawa, Canada), Evans Monyoncho, Spyridon Ntais, Tom Woo

[In-situ Polarization Modulation Infrared Reflection Absorption Spectroscopy \(PM-IRRAS\) for Rational Design of Pd-based Catalysts for Ethanol Electrooxidation](#)

s16-002

Valentín Briega-Martos (Instituto de Electroquímica, Universidad de Alicante, Alicante, Spain), José M. Orts, Enrique Herrero, Antonio Rodes, Juan Miguel Feliu Martinez

[Adsorption and Surface Reactivity of Acetonitrile on Pt\(hkl\) and its Effects on the Oxygen Reduction Reaction examined by Cyclic Voltammetry, in situ FTIR and DFT calculations](#)

s16-003

Chen Changguo (College of Chemistry and Chemical Engineering, Chongqing University, Chongqing, China)

[The Recent Development of Oxygen Reduction Reaction Carbon-Based Catalyst Prepared from Protein](#)

s16-004

Xiaoting Chen (Leiden Institute of Chemistry, Leiden University, Leiden, Netherlands), Ioannis Katsounaros, Marta Figueiredo, Federico Calle-Vallejo, Marc Koper

[Reductive Stripping of Saturated and Non-Saturated NO Adlayers on Pt Single-Crystal Electrodes](#)

s16-005

Beata Dembinska (Faculty of Chemistry, University of Warsaw, Warsaw, Poland), Kamila Brzozowska, Magdalena Skunik-Nuckowska, Marcin Pisarek, Pawel J. Kulesza

[Consideration of Mixed Rhenium Oxides as Catalytic Components During Electroreductions of Oxygen and Hydrogen Peroxide](#)

s16-006

Heiki Erikson (Institute of Chemistry, University of Tartu, Tartu, Estonia), Madis Lüsi, Ave Sarapuu, Kaido Tammeveski, Jose Solla-Gullón, Juan Miguel Feliu Martinez

[Oxygen Electroreduction on Carbon-Supported Palladium Nanocubes](#)

s16-007

Pablo Sebastian Fernandez (Chemistry, State University of Campinas, Campinas, Brazil), Yuvraj Y. Birdja, Marc Koper

[Towards a general understanding of the electrooxidation of polyols](#)

s16-008

Pablo Sebastian Fernandez (Chemistry, State University of Campinas, Campinas, Brazil), Cinthia Rodrigues Zanata, Gabriel da Silva, Agustin Silvio Picco, Caue Alves Martins, Giuseppe Abiola Camara, Maria Elisa Martins

[The electrooxidation of ethanol and glycerol on Pt_xSn_y/C carbon supported nanoparticles](#)

s16-009

Marta Figueiredo (Leiden Institute of Chemistry, Leiden University, Leiden, Netherlands), Ioannis Katsounaros, Yi-Fan Huang, Marc Koper

[Carbon Dioxide Interactions with Platinum Single Crystals](#)

s16-010

Andrey Goryachev (Chemical Engineering and Chemistry, Eindhoven University of Technology, Eindhoven, Netherlands), Francesco Carla, Jakub Drnec, Willem G. Onderwaater, Roberto Felici, Philipp P. T. Krause, Ad H. Wonders, Emiel J.M. Hensen, Jan P. Hofmann

[Synchrotron Based Operando Surface X-Ray Scattering Study Towards Structure-Activity Relationships of Model Electrocatalysts](#)

s16-011

Mareike Haensch (Institute of Chemistry, Carl von Ossietzky University of Oldenburg, Oldenburg, Germany), Gunther Wittstock

[Nanoporous gold - A prototype for a rational design of catalysts: Electrocatalysis and transport in nanoporous gold](#)

s16-012

Kim Jensen (DTU Physics, DTU, CINF, Kgs. Lyngby, Denmark), Jakub Tymoczko, Aliaksandr Bandarenka, Ib Chorkendorff, Maria Escudero-Escribano

[The Experimental Elucidation of the Oxygen Reduction Volcano in Alkaline Media, using Cu/Pt\(111\) Near-Surface Alloys](#)

s16-013

Ioannis Katsounaros (Leiden Institute of Chemistry, Leiden University, Leiden, Netherlands), Xiaoting Chen, Marta Figueiredo, Federico Calle-Vallejo, Marc Koper

[Electrochemistry of Nitrogen-Containing Compounds on Platinum Single-Crystals](#)

s16-014

Sara Morandi (Chemistry, Università degli Studi di Milano, Milano, Italy), Cristina Locatelli, Alessandro Minguzzi, Sandra Rondinini, Alberto Vertova, Vladimiro Dal Santo, Francesco Malara, Alberto Naldoni

[SECM Study of Innovative Hematite/Overlayers Architectures](#)

s16-015

Jan Vos (Leiden Institute of Chemistry, Leiden University, Leiden, Netherlands), Marc Koper

[Selective Water Oxidation on MnO₂ in the Presence of Chloride: Effect of pH and Chloride Concentration](#)

Electrochemical materials and interfaces

s16-016

Yassine Addi (Chimie, USTHB-ENPEI, ALgiers , Algeria), Ali Khouider

[Zinc –Nickel Coatings on Substrate in Presence of Cadmium in Acid Medium](#)

s16-017

Fabio Bottari (Department of Chemistry, University of Antwerp, Antwerp, Belgium), Karolien De Wael

[Surface modifications of Boron Doped Diamond electrodes: Electrochemical pretreatments for sensing of drugs and antibiotics](#)

s16-018

Adriana Correia (Analytical Chemistry and Physical Chemistry, Federal University of Ceara, Fortaleza, Brazil), Camila Sousa, Francisco Ribeiro, Michele Salvador, Paula Homem-de-Mello, Pedro De Lima-Neto, Adriana Correia

[Electrochemical and Computational Studies for Acetaminophen Detection using fMWCNT and Polyethylenimine Modified Electrode](#)

s16-019

Victor Emets (Electrocatalysis, Frumkin Institute of Physical Chemistry and Electrochemistry, Moscow, Russia), Alexey Melnikov, Boris Damaskin

[Electric double layer structure and specific adsorption of Cl⁻, Br⁻ and I⁻ ions on \(Cd-Ga\)/dimethylformamide interface](#)

s16-020

Ben Ern  (Physical and Colloid Chemistry, Debye Inst. Nanomater. Sci., Utrecht University, Utrecht, Netherlands), Mark Vis, Hans Tromp

[Spontaneous Electrification of Water-in-Water Emulsion Droplets](#)

s16-021

Graziela C.A. Ferreira (Physical Chemistry, Institute of Chemistry São Carlos, University of São Paulo, São Carlos, Brazil), Teko Napporn, Kouakou Boniface Kokoh, Hamilton Varela

[Oscillatory instabilities during the electro-oxidation of D-\(+\)-glucose on gold](#)

s16-022

Eibar Flores (Electrochemistry Laboratory, Paul Scherrer Institut, Villigen PSI, Switzerland), Rosa Robert, Petr Novák, Erik J. Berg

[Interface stability of the Li-ion cathode \$\text{LiNi}_{0.8}\text{Co}_{0.15}\text{Al}_{0.05}\text{O}_2\$ during overcharge and -discharge conditions](#)

s16-023

Yi-Fan Huang (Leiden Institute of Chemistry, Universiteit Leiden, Leiden, Netherlands), Marc Koper

[In-situ Raman spectroscopic study on the electrochemical oxidation of Pt\(111\) and Pt\(100\) single crystals](#)

s16-024

Svetlozar Ivanov (Electrochemistry and Electroplating Group, Ilmenau University of Technology, Ilmenau, Germany), Codruta Vlaic, Andreas Bund, Igor Efimov

[In Situ Analysis of Surface Roughness and Viscoelastic Effects During Deposition of Thin Silicon Layers From Ionic Liquid Electrolyte](#)

s16-025

Danqing Liu (Chemistry, University of Warwick, Coventry, United Kingdom), Patrick Unwin, Julie Macpherson, Chang-Hui Chen, Geoff West

[Factors Affecting the Solvent Window of Polycrystalline Boron-Doped Diamond Electrodes Revealed with Correlative Electrochemical-Microscopy](#)

s16-026

Ove Oll (Institute of Chemistry, University of Tartu, Tartu, Estonia), Georg Gorbatovski, Piret Pikma, Enn Lust, Heili Kasuk

[Formation of bipyridine self-assembled monolayers on Sb\(111\) electrode surface](#)

s16-027

Tamás Pajkossy (Institute of Materials and Environmental Chemistry, Research Centre for Natural Sciences, Budapest, Hungary), Soma Vesztergom, Katalin Németh, Claus Müller, Timo Jacob

[Interfacial capacitance spectra in ionic liquids](#)

s16-028

Micheál D. Scanlon (Chemistry, University College Cork, Cork, Ireland), Andrés Molina Osorio

[Interfacial \(photo\)electrochemistry and Raman spectroscopy of porphyrin functionalised soft interfaces](#)

s16-029

Yang Shang (School of Physics, Beihang University, Beijing, China)

[Investigation of \$\text{LiFePO}_4\$ Thin films as Li-ion Battery Cathode by in-situ Electrochemical Atomic Force Microscopy in Aqueous Electrolyte](#)

s16-030

Liis Siinor (Service de Chimie Analytique et Chimie des Interfaces, Université libre de Bruxelles, Bruxelles, Belgium), Carolin Siimenson, Thomas Doneux, Claudine Buess-Herman

[Electrochemical Characterization of \$\text{Au}\(\text{poly}\)|2.2' \text{-BP+BMMImNTf}_2\$ and \$\text{Au}\(111\)|2.2' \text{-BP+BMMImNTf}_2\$ Interfaces](#)

s16-031

Burton Simpson (Department of Chemistry, University of Illinois at Urbana-Champaign, Urbana, USA), Joaquin Rodriguez Lopez

[Electrochemical Imaging and Interrogation of Nano-Scale Reactive Domains During Photoelectrocatalysis](#)

s16-032

Eva-Maria Steyskal (Institute of Materials Physics, Graz University of Technology, Graz, Austria), Peter Pölt, Mihaela Albu, Roland Würschum

[Electrochemically Tunable Resistance of Nanoporous Platinum Produced by Dealloying](#)

s16-033

Momo Yaguchi (Section of Interfacial Spectrochemistry, Institute for Catalysis, Hokkaido University, Sapporo, Japan), Taro Uchida, Kenta Motobayashi, Masatoshi Osawa

[Adsorption of Phosphate Ions at Gold Electrodes at Various pH Values: An *In-Situ* Surface-Enhanced IR Spectroscopic Study](#)

s16-034

Kan Kan Yeung (Mechanical and Aerospace Engineering, Hong Kong University of Science and Technology, Hong Kong, China), Stephen Chin To Kwok, Francesco Ciucci, Matthew Ming-Fai Yuen

[Interfacial Kinetics Study of the Lead-acid Battery Electrode with Graphene Additive via Scanning Electrochemical Microscopy](#)

s16-035

Jeongse Yun (Department of Chemistry, Seoul National University, Seoul, Korea), Jae Gyeong Lee, Jin-Young Lee, Samuel Jaeho Shin

[Electrochemical Reaction in Metal-SiO₂-Si system mediated by Hydrogen Atom](#)

s16-036

Lingxing Zan (Electrochemistry Dept., Bonn university, Bonn, Germany), A.A. Abd-El-Latif, Helmut Baltruschat

[Investigation of antimony deposition on Au\(111\) by EC-STM](#)

Environmental technology

s16-037

Tamires Ferreira da Costa (Institute of Chemistry, Federal University of Rio Grande do Norte, Natal, Brazil), Dayanne Chianca de Moura, Ricardo Salazar, Marco Antonio Quiroz, Carlos Alberto Martinez-Huitle

[Electrochemical Degradation of Acid Blue 113 dye Using TiO₂-Nanotubes Decorated with PbO₂ as Anode](#)

Microscopy

s16-038

Leon Jacobse (Catalysis and Surface Chemistry, Leiden Institute of Chemistry - Leiden University, Leiden, Netherlands), Yi-Fan Huang, Marcel Rost, Marc Koper

[Live, in situ STM observation of the oxidative roughening of Pt\(111\)](#)

s16-039

Bryn Jones (Chemistry, University of Warwick, Coventry, United Kingdom), Patrick Unwin

[Bias-Modulated Scanning Ion Conductance Microscopy as a Tool to Investigate Surface Chemistry](#)

s16-040

Can Liu (Institute for Catalysis, Hokkaido University, Sapporo, Japan), Yu Qiao, Shen Ye

[In-situ AFM Observations of Oxygen Reduction Reaction on the Cathode Surface of the Li-O₂ Battery](#)

s16-041

Ove Oll (Institute of Chemistry, University of Tartu, Tartu, Estonia), Erik Anderson, Carolin Siimenson, Laura Läll, Enn Lust

[In Situ STM Studies of Electrochemical Stability and 2D Layer Formation at Bi\(111\)|Halide Ionic Liquid Mixture Interface](#)

Molecular electrochemistry

s16-042

Hiro Minamimoto (Department of Chemistry, Faculty of Science, Hokkaido University, Sapporo, Japan), Satoshi Yasuda, Kei Murakoshi

[Observation of Water Molecules at Hydrogen Evolution Process using in-situ Electrochemical Surface-Enhanced Raman Scattering](#)

Spectroscopic methods

s16-043

Alina Belova (Department of Materials Sciences, Lomonosov Moscow State University, Moscow, Russia), Luca Gregoratti, Matteo Amati, Hikmet Sezen, Elmar Kataev, Olesya Kapitanova, Daniil Itkis, Lada Yashina
[XPS imaging of Li₂O₂ formation on graphene electrodes upon the discharge of solid state Li-O₂ battery](#)

s16-044

Ismael Díez (Physical Chemistry Department, University of Barcelona, Barcelona, Spain), Juan Manuel Artes Vivancos, Fausto Sanz, Pau Gorostiza, Montse López
[Conductance imaging of electronic materials and redox proteins in aqueous solution at the nanoscale](#)

s16-045

Shu Hu (College of Chemistry and Chemical Engineering, Xiamen University, Xiamen, China), Zhang Yue-Jiao, Juan-Juan Sun, Kai-Qiang Lin, Bi-Ju Liu, Jian-Feng Li, Bin Ren
[Electrochemical dark-field scattering technique for in situ monitoring the UPD process of silver on single gold nanoparticles](#)

s16-046

Sheng-Chao Huang (College of Chemistry and Chemical Engineering, Xiamen University, Xiamen, China), Zhi-Cong Zeng, Xiang Wang, Teng-Xiang Huang, Jin-Hui Zhong, Bin Ren
[Electrochemical TERS monitoring the nanoscale decarboxylation reaction driven by the synergistic plasmonic and electrocatalytic effect](#)

s16-047

Danai Panagoulia (Chemistry, University of Southampton, Southampton, United Kingdom), Robert Johnson, Tammy Nimmo, Andrea Russell
[Exploring the Metal - Ionic Liquid Interface using Electrochemical SERS on Nanostructured Substrates](#)

s16-048

Francisco Prieto (Physical Chemistry, University of Seville, Seville, Spain), Julia Alvarez-Malmagro, Manuela Rueda
[In situ Surface-Enhanced Infrared Spectroscopy Study of Adsorbed Thymine Tautomers on Gold Electrodes and their Interactions with Co-Adsorbed Adenine](#)

s16-049

Mara Serrapede (Dipartimento Scienza Applicata e Tecnologia (DISAT), Politecnico di Torino, Torino, Italy), Mara Serrapede, Simone Marasso, Stefano Bianco, Andrea Lamberti, Anca Luiza Ionescu, Candido F. Pirri, Elena Tresso
[Study of Faradaic and Non-Faradaic Charge Storage Contributions in Graphene-Based Supercapacitors Using Electrochemical Methods](#)

s16-050

Siti N.A. Zakaria (Chemistry, University College London, London, United Kingdom), Husn-Ubayda Islam, Nathan Hollingsworth, Alberto Roldan-Martinez, Katherine B. Holt
[Spectroelectrochemical Studies of Iron Sulfides for CO₂ Reduction](#)

s16-051

Jorge O. Zerbino (Electrochemistry, Instituto de Inv. Físicoquímicas, INIFTA, La Plata, Argentina), Ricardo I. Tucceri, Alberto Maltz
[Conductivity of Poly\(o-aminophenol\) films and its dependence on the storage time and electrolyte solution composition](#)

Theoretical modeling and simulation

s16-052

Tamires Ferreira da Costa (Institute of Chemistry, Federal University of Rio Grande do Norte, Natal, Brazil), Carlos Alberto Martinez-Huitle, Paola Quaino, Elizabeth Santos, Wolfgang Schmickler, Maria Fernanda Juarez
[Theoretical Studies of Diamond Surfaces – Effect of the Boron-Doping on the Adsorption of Different Species](#)

s16-053

Fabian Single (German Aerospace Center (DLR), Helmholtz Institute Ulm (HIU), Ulm, Germany), Birger Horstmann, Arnulf Latz

[Modeling Solid Electrolyte Interphase Formation and Morphology](#)

s16-054

Markus Sinstein (Theoretische Chemie, Technische Universität München, Garching, Germany), Harald Oberhofer, Daniel Berger, Karsten Reuter

[Continuum Embedding for Photo-Electrochemical Surface Processes](#)

s16-055

Libuse Trnkova (Department of Chemistry, Faculty of Science, Masaryk University, Brno, Czech Republic)

[Elimination Voltammetry with Potential Shift](#)

Symposium 17 Attention: Theory Only

Charge transfer in low-dimensional structures

s17-001

P. Ulrich Biedermann (Interface Chemistry and Surface Engineering, Max-Planck-Institut für Eisenforschung GmbH, Düsseldorf, Germany), Simantini Nayak, Andreas Erbe

[The Electrochemical Oxygen Reduction Mechanism: Combined DFT and In-Situ ATR-IR Study on Semiconductor Surfaces](#)

s17-002

Zinaida Kostiuhenko (TNW-Nanoionics, University of Twente, Enschede, Netherlands), Serge Lemay

[Stochastic charge fluctuations in bipolar electrodes](#)

s17-003

Pekka Peljo (Laboratoire d'Electrochimie Physique et Analytique, Ecole Polytechnique Fédérale de Lausanne, Sion, Switzerland), Nico Holmberg, Kari Laasonen, Jose Manzanares, Hubert Girault

[Contact Potentials, Fermi Level Equilibration and Charge Distribution: Effect on Electrocatalysis](#)

Nanoconfinement and nanostructures

s17-004

Luis Balboa (Department of Chemistry, Oldenburg, Germany), Gunther Wittstock

[Modeling and simulation of transient scanning electrochemical microscopy response of porous electrodes](#)

Structure and dynamics of interfacial water

s17-005

Zhengda He (Chemistry, Leiden Institute of Chemistry, Leiden, Netherlands), Federico Calle-Vallejo, Marc Koper

[Solvation Correction for *OH Adsorption Energies on Transition Metal Surfaces](#)

Structure formation and dynamics in electrochemical systems

s17-006

Darren Buesen (Center for Electrochemical Science (CES), Ruhr-Universität Bochum, Bochum, Germany), Nicolas Plumeré

[Electroanalytical Methods and Simulation for the Determination of Redox Film Thickness in the Solvated State](#)

s17-007

Olga Gichan (Institute of Surface Chemistry, Henerala Naumova 17, Kyiv, Ukraine), Valentina Pototskaya
[Ohmic Losses and Dynamic Instabilities in Electrochemical Systems](#)

s17-008

Adrien Göttle (Catalysis and surface chemistry, Leiden Institute of Chemistry, Leiden, Netherlands), Jing Shen, Manuel Kolb, Marc Koper
[Electrochemical Reduction of CO₂ Catalyzed by Cobalt Porphyrin Complexes: a Mechanistic Study from DFT.](#)

s17-009

Hendrik H. Heenen (Theoretical Chemistry, Technische Universität München, Garching, Germany), Simone S. Köcher, Christoph Scheurer, Karsten Reuter
[Simulating experimental length- and timescales: Li ion mobility in occupationally disordered battery materials](#)

s17-010

Manuel Landstorfer (RG 7-Thermodynamic Modeling and Analysis of Phase Transition, Weierstrass Institute for Applied Analysis and Stochastics, Berlin, Germany), Clemens Gohlke, Ruediger Mueller, Wolfgang Dreyer
[New insights on the interfacial tension of electrochemical interfaces and the Lippmann equation](#)

s17-011

Michele Tedesco (Wetsus, Wetsus, Leeuwarden, Netherlands), Bert Hamelers, Maarten Biesheuvel
[Influence of Water Transport in \(Reverse\) Electrodialysis](#)

s17-012

Mikhail Vorotyntsev (Lomonosov Department, Lomonosov Moscow State University, Moscow, Russia), Yury Tolmachev, Dmitry Konev, Anatoly Antipov
[Novel Autocatalytic Mechanism of Electrochemical Processes and Its Implications for Electrical Energy Sources](#)

Theory of random heterogeneous media

s17-013

Sze-yin Tan (Department of Chemistry, University of Warwick, Coventry, United Kingdom), Jie Zhang, Alan M. Bond, Julie Macpherson, Patrick Unwin
[Fourier-Transformed Alternating Current Voltammetry as a Probe of Spatially Heterogeneous Electron Transfer Kinetics](#)

s17-014

Xueqing Zhang (Solar Fuels, Dutch Institute For Fundamental Energy Research, Eindhoven, Netherlands), Peter Klaver, Rutger van Santen, Richard van de Sanden, Anja Bieberle-Hütter
[Simulation of the Oxygen Evolution Reaction at Hematite Surfaces](#)

Symposium 18 Electrochemistry, Photo-Electrochemistry and Bioelectrochemistry of Artificial Photosynthesis: Recent Advances in CO₂ Conversion to Products

CO₂ conversion and utilization

s18-001

Pablo Ampudia Castresana (Dipartimento di ingegneria meccanica, chimica e dei material, Università degli studi di Cagliari, Cagliari, Italy), Pablo Ampudia Castresana, Annalisa Vacca, Michele Mascia, Simonetta Palmas
[Electrochemical behaviour of synthesized Cu-Ni composites for CO₂ electroreduction](#)

s18-002

Fethi Bedioui (Technologies Chimiques et Biologiques pour la Santé, CNRS-Chimie ParisTech-INSERM- Univ Paris Descartes, Paris, France), Marcelo Girardi, Anna Proust, Sebastien Blanchard, Sophie Griveau
[Polyoxometalates : Potential Catalysts for the Electroassisted Reduction of CO₂](#)

s18-003

Florent Boissou (IC2MP - UMR CNRS 7285, University of Poitiers, Poitiers, France), Stève Baranton, Karine Vigier, Christophe Coutanceau
[Electrochemical reduction of CO₂ in choline chloride based deep eutectic solvents \(DES\)](#)

s18-004

M.Amin Farkhondehfal (Applied science and technology (DISAT), Politecnico di Torino, Turin, Italy), M.Amin Farkhondehfal, Simelys Hernandez, Andrea Lamberti, Guido Saracco, Candido F. Pirri, Nunzio Russo
[Electrochemical CO₂ reduction for CO production exploiting Ag-decorated TiO₂ nanotubes](#)

s18-005

Dorottya Hursán (MTA-SZTE Lendület Photoelectrochemistry Research Group, University of Szeged, Szeged, Hungary), Gábor London, Csaba Janáky
[Custom-designed Electroactive Polymers for H₂ evolution and CO₂ Reduction](#)

s18-006

Ewelina Szaniawska (Department of Chemistry, University of Warsaw, Warsaw, Poland), Krzysztof Bienkowski, Renata Solarz, Iwona A. Rutkowska, Pawel J. Kulesza
[Generation of Alternative Fuels Through Photoelectrochemical Reduction of Carbon Dioxide](#)

s18-007

Maria Valnice Boldrin Zanoni (Analytical Chemistry, Institute of Chemistry, Universidade Estadual Paulista, Araraquara, Brazil), Juliana Ferreira Brito
[On the Application of Ti/TiO₂/CuO n-p Junction Semiconductor: A case study of Electrolyte and Potential Influence on CO₂ Reduction](#)

CO₂ electrochemistry

s18-008

Xue-Jiao Chen (College of Chemistry and Chemical Engineering, Xiamen University, Xiamen, China), Song Yu, De-Yin Wu, Zhong-Qun Tian
[Mechanistic Research on the Pyridine-Catalytic Electrochemical Reduction of CO₂ at the Pt surface Based on the Surface-Enhanced Raman Spectroscopic Study](#)

s18-009

Nienke Firet (Materials for Energy Conversion and Storage, Delft University of Technology, Delft, Netherlands), Wilson Smith
[Probing the reaction mechanism of CO₂ reduction using ATR-FTIR](#)

s18-010

Xin-Ming Hu (Interdisciplinary Nanoscience Center (iNANO), Aarhus University, Aarhus, Denmark), Zakaria Salmi, Mie Lillethorup, Emil B. Pedersen, Marc Robert, Steen U. Pedersen, Troels Skrydstrup, Kim Daasbjerg
[Controlled Electropolymerisation of a Carbazole-Functionalised Iron Porphyrin Electrocatalyst for CO₂ Reduction](#)

- s18-011
Mauricio Isaacs (Departamento de Química Inorgánica, Pontificia Universidad Católica de Chile, Santiago, Chile), Esteban Landaeta, Diego Quezada, Jessica Honores, Diego Guzman, Ricardo Schrebler, Ana Burgos
[Synthesis of Cu₂O Supported Lignin Modified Electrodes: Photo-electrocatalysis for CO₂ Reduction](#)
- s18-012
Ryosuke Jinnouchi (Smart Material Design Division, Toyota Central R&D Labs., Inc., Nagakute, Japan), Alexey Akimov, Soichi Shirai, Ryoji Asahi, Oleg Prezhdo
[Theoretical Simulation on Electron Transfer at Ru-complex/N-Ta₂O₅ interface for Photocatalytic CO₂ reduction](#)
- s18-013
Juan Manriquez (Dept. of Research, CIDETEQ, Pedro Escobedo, Mexico), Jorge-Alberto Banda-Alemán, Selene Sepúlveda-Guzmán
[Electrochemical CO₂ reduction on Ag nanodendrites electrodeposited on In-doped SnO₂ electrodes immersed in aprotic medium](#)
- s18-014
Roman Míchez (Faculté des Sciences, Université libre de Bruxelles, Bruxelles, Belgium), Thomas Doneux, Claudine Buess-Herman
[Influence of the Ionic Liquid Nature on the Electrochemical Reduction of CO₂](#)
- s18-015
Javier Monzó (School of Chemistry, University of Birmingham, Birmingham, United Kingdom), Yvonne Malewski, Ruud Kortlever, Francisco Jose Vidal-Iglesias, Jose Solla-Gullón, Marc Koper, Paramaconi Rodriguez
[Enhanced Electrocatalytic Activity of Au@Cu Core@shell Nanoparticles Towards CO₂ Reduction](#)
- s18-016
Hideshi Ooka (Leiden Institute of Chemistry, Universiteit Leiden, Leiden, Netherlands), Marc Koper
[Competition of Carbon Dioxide Reduction and Hydrogen Evolution on Copper Electrodes](#)
- s18-017
Anna Wuttig (Chemistry, Massachusetts Institute of Technology, Cambridge, USA), Anna Wuttig, Momo Yaguchi, Kenta Motobayashi, Masatoshi Osawa, Yogesh Surendranath
[Inhibited Proton Transfer Enhances Au-catalyzed CO₂-to-Fuels Selectivity](#)

Electrocatalytic conversion

- s18-018
Yuvraj Y. Birdja (Catalysis and Surface Chemistry, Leiden Institute of Chemistry, Leiden, Netherlands), Marc Koper
[Boron Doped Diamond as electrocatalyst for solar fuel production](#)
- s18-019
Guay Daniel (Energie, Matériaux, Télécommunications, INRS, Varennes, Canada), Claudie Roy, Sébastien Garbarino, Erwan Bertin
[Electrodeposited Catalysts: From Formic Acid Oxidation on Pt\(100\) to Carbon Dioxide Electroreduction on Bi](#)
- s18-020
Dennis Kopljar (Institute of Chemical Technology, University of Stuttgart, Stuttgart, Germany), Norbert Wagner, Elias Klemm
[Development and Optimization of Gas Diffusion Electrodes for Electrochemical CO₂ Reduction at High Current Density](#)
- s18-021
Fengwang Li (School of Chemistry, Monash University, Melbourne, Australia), Shu-Feng Zhao, Lu Chen, Azam Khan, Douglas MacFarlane, Jie Zhang
[Polyethylenimine Promoted Electrocatalytic Reduction of CO₂ to CO in Aqueous Medium by Graphene-Supported Amorphous Molybdenum Sulphide](#)

s18-022

Anna Lisowska-Oleksiak (Faculty of Chemistry, Gdansk University of Technology, Gdańsk, Poland), Mariusz Szkoda

[The highly ordered hetero-junction combining titania nanotubes and Prussian Blue network imbedded inside PEDOT matrix exhibiting FeII/FeIII redox activity and enhanced photoactivity](#)

s18-023

Elena Perez Gallent (CASC / LIC, Leiden University, Leiden, Netherlands), Marta Figueiredo, Ioannis Katsounaros, Marc Koper

[Electrocatalytic Reduction of Nitrate on Copper Single Crystals](#)

s18-024

Ali Shahraei (Department of Materials- and Earth Science, TU Darmstadt, Darmstadt, Germany), Ulrike I. Kramm

[On the role of metal species in Me-N-C catalysts for Hydrogen Evolution Reaction in Alkaline environment](#)

s18-025

Robbe Vervecken (Faculty of Applied Engineering, University of Antwerp, Wilrijk, Belgium), Bart Geboes, Jonas Hereijgers, Vera Meynen, Tom Breugelmans

[The use of Ag/Cu core-shell nanoparticles for the reduction of CO₂](#)

s18-026

Luciana Vieira (Assistant Bio, Electro and Chemocatalysis BioCat, Fraunhofer Institute IGB, Straubing, Germany), Sunil Kavunga, Lenard-Istvan Csepei, Tobias Gärtner, Fabian Steffler, Volker Sieber

[Electro-Bio-Catalytic Conversion of CO₂ to Valuable Products](#)

Microbial Electrosynthesis

s18-027

Deepak Pant (Separation & Conversion Technologies, VITO - Flemish Institute for Technological Research, MOL, Belgium), Sandipam Srikanth, Karolien Vanbroekhoven

[Dehydrogenase cascade at cathode for bioelectrochemical production of ethanol from CO₂: Role of carbonic anhydrase](#)

Photo and Plasma Electrochemistry

s18-028

Pablo Ampudia Castresana (Dipartimento di ingegneria meccanica, chimica e dei material, Università degli studi di Cagliari, Cagliari, Italy), Laura Mais, Simonetta Palmas, Michele Mascia, Annalisa Vacca

[Enhancement of the WO₃ performances for PEC applications](#)

s18-029

Louzhen Fan (Department of Chemistry, Beijing Normal University, Beijing, China), Mo Zhang

[Synthesis of Fluorescent Graphene Quantum Dots for Stem Cell Platform](#)

s18-030

Paula Grez (Instituto de Química, Pontificia Universidad Católica de Valparaíso, Valparaíso, Chile), Luis Ballesteros, Carlos Celedón, Christopher Heyser, Camila Rojas, Ricardo Schrebler

[Synthesis and characterization of Cu₂O nanostructures formed by anodization sonoelectrochemical](#)

s18-031

Mohammadamin Haghghatbin (Department of Chemistry and Physics, La Trobe Institute of Molecular Sciences (LIMS), Melbourne, Australia), Gregory Barbante, P.L. Burn, S-C. Lo, Conor Hogan

[Spectroscopic, electrochemical and electrochemiluminescent properties of highly luminescent Iridium\(III\) 1,2,4-triazole complexes](#)

s18-032

Chao Han (Nanjing Institute of Geography and Limnology, Chinese Academy of Sciences, Nanjing, China)[Quantitative Imaging of pH Distribution in Alkaline Sediments and Water Based on a New Rapid Response Fluorescent Planar Optode](#)

s18-033

Sina Hejazi (Department of Materials Science, WWIV-LKO, Friedrich-Alexander-Universität Erlangen-Nürnberg, Erlangen, Germany), Sina Hejazi, Nhat Truong Nguyen, Anca Mazare, Patrik Schmuki[Hydrothermal amine treatment of TiO₂ nanotube for improving photocurrent response](#)

s18-034

Cristopher Heyser (Instituto de Química, Pontificia Universidad Católica de Valparaíso, Valparaíso, Chile), Ricardo Schrebler, Javier Roman, Paula Grez[Synthesis and Characterization of Electrical and Morphological Properties of NiO](#)

s18-035

Chengyi Hou (DTU Chemistry, Technical University of Denmark, Kgs. Lyngby, Denmark), Minwei Zhang, Christian Engelbrekt, Qijin Chi[Reagent-free electrolytic synthesis of metal-metal oxide core-shell microfibers with plasmonic anti-oxidation functionality](#)

s18-036

Mahsa Saeedi Maleki (Department of Chemistry and Physics, La Trobe Institute for, La Trobe University, Melbourne, Australia), Conor Hogan[Low Cost Sensing of Pseudoephedrine with Electrochemiluminescence Detection](#)

s18-037

Longfei Wu (Department of Chemical Engineering and Chemistry, Eindhoven University of Technology, Eindhoven, Netherlands), Longfei Wu, Nelson Y. Dzade, Lu Gao, Nora H. de Leeuw, Emiel J.M. Hensen, Jan P. Hofmann[Mixed Iron Pyrite-Marcasite Films with Enhanced Photo-Response](#)

s18-038

Jianbo Wu (College of Physics & Electronic Engineering, Taizhou University, Taizhou, China), Weiping Chen, Renqing Guo[Heterostructured BiOCl/Ag₃PO₄ for Photoelectrochemical Water Splitting](#)

Solar fuels

s18-039

Alexander Milbrat (TNW, University of Twente, Enschede, Netherlands), Rick Elbersen, Recep Kas, Roald Tiggelaar, Han Gardeniers, Guido Mul, Jurriaan Huskens[Spatioselective Electrochemical and Photoelectrochemical Functionalization of Silicon Microwires with Axial p/n Junctions](#)

s18-040

Thibaut Stoll (Solar Fuels, Dutch Institute for fundamental energy research, DIFFER, Eindhoven, Netherlands)[Towards visible light activated porous photoanodes in conjunction with polymeric electrolyte photoelectrochemical cell with gaseous reactants](#)

s18-041

Georgios Zafeiropoulos (Solar Fuels, Dutch Institute for fundamental energy research, DIFFER, Eindhoven, Netherlands)[H₂ production in polymeric electrolyte photoelectrochemical cell with titania nanotube arrays as photoanode and gaseous reactants](#)

Symposium 20 General Session

Analytical Electrochemistry

s20-001

Alejandro Alvarez-Lueje (Pharmacological and Toxicological Chemistry, University of Chile, Santiago, Chile)
[Voltammetric Studies of Drugs using Carbon-Based Electrodes Modified with Ionic Liquids](#)

s20-002

William Araujo (Department of Fundamental Chemistry, University of São Paulo, São Paulo, Brazil), Thiago Paixão
[Electrochemical detection of paracetamol in confiscated cocaine samples using a simple and low cost office paper-based analytical device](#)

s20-003

Ricardo F. Brocenschi (Chemistry Department, Federal University of São Carlos (UFSCar), São Carlos, Brazil), Adriana A. Almeida, Douglas A.C. Coledam, Romeu C. Rocha-Filho, Nerilso Bocchi, Sonia R. Biaggio
[Electrochemical determination of norfloxacin in drugs and biological fluids using a cathodically pretreated boron-doped diamond electrode](#)

s20-004

Arturo García-Mendoza (Analytical Chemistry, Universidad Nacional Autónoma de México, Mexico City, Mexico), Carlos M. Bermejo-Gerardo, Julio C. Aguilar
[Electrochemical study of interfaces between electrical conductors and imidazolium-based ionic liquids.](#)

s20-005

Takashi Kakiuchi (Department of Chemistry of Functional Molecules, Konan University, Kobe, Japan), Keisuke Kamon, Masahiro Yamamoto
[Formal and mid-point potentials of ferricyanide/ferrocyanide redox couple demonstrate the significance of single-ion activity in electrochemistry](#)

s20-006

Carsten Korte (IEK-3, Forschungszentrum Jülich GmbH, Jülich, Germany), Fosca Conti, Werner Lehnert
[Changes in phosphoric acid at elevated temperature in humidified air](#)

s20-007

Christian Merdon (Numerical Analysis Group, Weierstrass Institute for Applied Analysis and Stochastics, Berlin, Germany), Jürgen Fuhrmann, Alexander Linke, A.A. Abd-El-Latif, Mehdi Khodayari, Philip Reinsberg, Helmut Baltruschat
[Inverse Modelling of Thin Layer Flow Cells and RRDEs](#)

s20-008

Joan Piquero Cilla (Química analítica, Universitat de València, Valencia, Spain), Xavier Ferragud, Vicent Guerola Blay, Ximo Company, María Teresa Doménech-Carbó, Antonio Doménech-Carbó
[Electrochemical Analysis of Golden Ornamentation in the Valencian Region \(Spain\) between the 15th and 20th Centuries](#)

s20-009

Jorge Redondo Marugán (Institut de Restauració del Patrimoni, Universitat Politècnica de València, Valencia, Spain), Antonio Doménech-Carbó, María Teresa Doménech-Carbó, Laura Osete-Cortina, Joaquín Barrio, Angel Fuentes, María Victoria Vivancos-Ramón, Wassef Al Sekhaneh
[Diagnostic Criteria for Authentication of Archeological Leaded Bronze Objects using the Voltammetry of Immobilized Particles](#)

s20-010

Thiago Selva (Department of Fundamental Chemistry, Chemistry Institute, University of São Paulo, São Paulo, Brazil), Thiago Paixão
[Electrochemical Quantification of Propoxur Carbamate Pesticide using a Boron-Doped Diamond Electrode](#)

s20-011

José Ricardo Silva (Institute of Chemistry, University of Sao Paulo, Sao Paulo, Brazil), William Araujo, Thiago Paixão
[Sono-electrochemical Paper-Based Sensor for Metal Stripping Analysis](#)

s20-012

Irina Svir (Department of Chemistry, CNRS UMR 8640 'PASTEUR', Ecole Normale Supérieure, Paris, France), Oleksii Sliusarenko, Alexander Oleinick, Christian Amatore

[Validating a Central Approximation in Theories of Regular and Random Electrochemical Electrode Arrays](#)

s20-013

Adrian de-Santiago (Analytical Chemistry, Universidad Nacional Autónoma de México, México City, México), Dulce Consuelo Guzmán-Ocampo, Juan Felipe Huan Lew-Yee, Arturo García-Mendoza, Alejandro Baeza

[Microscale coulometric acid-base titration with locally produced instrumentation.](#)

s20-014

Adrian de-Santiago (Analytical Chemistry, Universidad Nacional Autónoma de México, México City, México), Dulce Consuelo Guzmán-Ocampo, Juan Felipe Huan Lew-Yee, Arturo García-Mendoza, Alejandro Baeza

[Microscale potentiometric stripping analysis with locally produced instrumentation](#)

Bioelectrochemistry

s20-015

Mirela Enache (Surface Chemistry and Catalysis, Institute of Physical Chemistry Ilie Murgulescu, Bucharest, Romania), Mirela Enache, Mihai Anastasescu, Catalin Negri, Mihai F. Lazarescu, Valentina Lazarescu

[Electrochemical Behavior of Epinephrine on L-Cysteine Modified GaAs\(100\) Electrode](#)

s20-016

Efe Deniz Oztürk (Faculty of Science, Biochemistry Department, Ege University, İzmir, Turkey), Erol Akyılmaz, Elcin Ad, Ihsan Yasa, Hayati Türkmen, M. Emin Günay

[Development Of A Novel Gold Nanoparticle-Ionic Liquid Nanostructure Modified Pleurotus Ostreotus Based Microbial Biosensor System And Its Adaptation For The Determination of Bisphenol A](#)

s20-017

Carla Santana Santos (Fundamental Chemistry, University of São Paulo, 748, Prof. Lineu Prestes Avenue, São Paulo, Brazil), Mauro Bertotti

[Investigations of Mitochondrial Respiration by Scanning Electrochemical Microscopy](#)

Electrochemical Energy Conversion and Storage

s20-018

Paula Enciso (Laboratorio de Biomateriales, Facultad de Ciencias, Universidad de la República, Montevideo, Uruguay), María Fernanda Cerdá, Jean-David Décoppet, Michael Graetzel

[Influence of Coadsorbents in the Adsorption of Phycocyanin on the Performance in DSSC](#)

s20-019

Alberto Ganassin (Chemistry, Ruhr-Universität Bochum, Bochum, Germany), Aliaksandr Bandarenka, Wolfgang Schuhmann

[Insights into the chlorine evolution reaction and investigation of the solvent influence on the Cl₂/O₂ selectivity](#)

s20-020

Sang-hyeon Ha (Energetics and Defense Materials, Agency for Defense Development, Daejeon, Korea), Jaemin Lee, Hyunki Yoon, Byeong June Park, Jang-Hyeon Cho

[A Study on low temperature performance prediction of lithium-ion battery using modeling and simulation](#)

s20-021

Ghoncheh Kasiri Bidhendi (Energiespeicher- und Energiewandlersysteme, Bremen Universität, Bremen, Germany), Amir Bani Hashemi, Rafael Trócoli, Fabio La Mantia

[The Effect of Electrolyte Concentration on the Aging of Copper Hexacyanoferrate in Zinc-ion Batteries](#)

s20-022

Kiyoul Kim (4th R&D Institute, Agency for Defense Development, Daejeon, Korea), Jaemin Lee, Sanghyun Ha

[Temperature distribution of thermal battery by numerical simulation](#)

s20-023

Ioannis Kotoulas (Chemical Engineering, Aristotle University, Thessaloniki, Greece), Agoritsa Schizodimou
[Electrochemical Reduction of Formic Acid on Copper Cathode in Concentrated Phosphoric Acid](#)

s20-024

Jaemin Lee (The 4th R&D Institute, Agency of Defense Development, Daejeon, Korea), Hyunki Yoon, Sanghyeon Ha, Yusong Choi
[Electrochemical Impedance Study of Li-ion Batteries under Temperature Control to Have Good Low Temperature Performance](#)

s20-025

Jaemin Lee (The 4th R&D Institute, Agency of Defense Development, Daejeon, Korea), Hyunki Yoon, Sanghyeon Ha, Yusong Choi
[Hetero-layer Electrolyte of Thermal Batteries for Reducing Self-discharge](#)

s20-026

Markus Lickleder (Department of Material Science, Friedrich Alexander Universität, Erlangen, Germany), Robert Hahn, Patrik Schmuki
[Use of Nanotubular Titanium Disulfide in Dye-sensitized Solar Cells](#)

s20-027

Markus Lickleder (Department of Material Science and Engineering, Friedrich Alexander Universität, Erlangen, Germany), Robert Hahn, Patrik Schmuki
[Use of nanostructured TiS₂ in Dye-sensitized Solar Cells](#)

s20-028

Hyun-Kon Song (Chemical Engineering, UNIST, Ulsan, Korea), Dong-Gyu Lee, Jung Min Oh
[Completion of Oxygen Reduction on Oxide Catalysts](#)

s20-029

Bernard John Tongol (Chemistry, University of Santo Tomas, Manila, Philippines), Hannah Grace Geronimo, Maria Krisandra Mendoza
[Development of Fuel Cell Cathode Catalysts based on Polyaniline-Iron-Carbon Black and Polyaniline-Iron-Graphene Composites](#)

Electrochemical Materials Science

s20-030

Francesco Carla (ID03 beamline, ESRF - The European Synchrotron, Grenoble, France)
[Structure, Order and Epitaxy during electrochemical layer by layer growth](#)

s20-031

Vasilena Karabozhikova (Institute of Physical Chemistry, Bulgarian Academy of Sciences, Sofia, Bulgaria), Vesela Tsakova
[Electroless Deposition of Silver on Poly\(3,4-ethylenedioxythiophene\) – Role of the Doping Ions](#)

s20-032

Yunny Meas (Electrochemistry, CIDETEQ, Pedro Escobedo, Mexico), Ildefonso Zamudio-Torres, José de Jesús Pérez-Bueno
[Validating the Corrosion Rate by mean of Electrochemical Frequency Modulation \(EFM\) in TiO₂ Nanotubes](#)

s20-033

Manuel Palomar-Pardavé (Materiales, Universidad Autonoma Metropolitana Azcapotzalco, Mexico City, Mexico), Iván Aldana-González, Luis Botello, Elsa Arce-Estrada, María Guadalupe Montes de Oca, Jorge Mostany, Mario Romero-Romo
[Electrochemical Formation of Fe Nano-clusters From a Deep Eutectic Solvent](#)

s20-034

Dagmar Rückle (Korrosion- und Korrosionsschutz, Materialprüfungsanstalt (MPA) - Universität Stuttgart, Stuttgart, Germany), Stefanie Kaesche, Sannakaisa Virtanen, Harald Garrecht
[Electrochemical impedance spectroscopy \(EIS\) of different metals in nitrate molten salt for solar thermal power plants at high temperatures](#)

s20-035

Nelson Stradiotto (Department of Analytical Chemistry, Institute of Chemistry, Universidade Estadual Paulista, Araraquara, Brazil), Patricia Lee, Her Shuang Toh, Chris Salter, Colin Johnston, Richard G. Compton

[The Electro-Oxidation of Lactic Acid: Contrasting Platinum Particles and Polycrystalline Platinum Macro Electrode](#)

s20-036

Bart Vanreenterghem (Faculty of Applied Engineering, University of Antwerp, Wilrijk, Belgium), Emlyn Wouters, Tom Breugelmans

[The reduction of organic halides at Ag-Ni deposits prepared by galvanic replacement](#)

s20-037

Kai Wang (Guangdong Welding Institute, Guangdong academy of sciences, Guangzhou, China), Yaoyong Yi, Ben Niu, Rui Chen, Jianglong Yi

[Microstructure and Electrochemical Behavior of the Q690 HSLA Steel at Different Thermal Simulation Status](#)

s20-038

Jianglong Yi (Guangdong Welding Institute, Guangdong Academy of Sciences, Guangzhou, China), Kai Wang, Xinxin Wang, Ben Niu, Chunlin Dong

[Effects of TiO₂ addition on the electrochemical performance of the overlay welded high-manganese steel cladding](#)

Electrochemical Process Engineering and Technology

s20-039

Alexey Davydov (Laboratory of Physical Electrochemistry, Frumkin Institute of Physical Chemistry and Electrochemistry, Moscow, Russia), Tatyana Kabanova, Vladimir Volgin, Victor Lyubimov, Inna Gnidina

[Modeling of Formation of Microstructured Surface during Local Anodic Dissolution using Moving Cathode](#)

s20-040

Javier Llanos (Department of Chemical Engineering, University of Castilla-la Mancha, Ciudad Real, Spain), Inmaculada Moraleda, Javier Llanos, Cristina Sáez, Salvador Cotillas, Manuel A. Rodrigo, Pablo Cañizares

[Role of sp³/sp² Ratio of BDD Layer and Initial Chloride Concentration in the Synthesis of Oxidants](#)

s20-041

Victor Lyubimov (Dept. Electro- and Nanotechnologies, Tula State University, Tula, Russia), Vladimir Volgin, Inna Gnidina, Alexey Davydov, Tatyana Kabanova

[Simulation of Wire Electrochemical Micromachining](#)

s20-042

Vladimir Volgin (Dept. Electro- and Nanotechnologies, Tula State University, Tula, Russia), Daniil Bograchev, Alexey Davydov, Tatyana Kabanova

[Mass Transfer during Metal Electrodeposition into the Pores of Anodic Aluminum Oxide from a Binary Electrolyte under the Potentiostatic and Galvanostatic Conditions](#)

s20-043

Daniela Wintrich (Analytical Chemistry – Center for Electrochemical Sciences, Ruhr-Universität Bochum, Bochum, Germany), Justus Masa, Wolfgang Schuhmann

[Correlation between RRDE and SECM in determining the number of transferred electrons – a theoretical approach](#)

Molecular Electrochemistry

s20-044

Jeanet Conradie (Department of Chemistry, University of the Free State, Bloemfontein, South Africa), Karel G. Von Eschwege, Hendrik Ferreira

[Redox Potential of Tris\(1,10-phenantroline\)iron\(II\) Complexes – Relationships with Calculated Parameters](#)

s20-045

Jeanet Conradie (Department of Chemistry, University of the Free State, Bloemfontein, South Africa), Annemarie Kuhn

[Electrochemical behaviour of bis\(cyclopentadienyl\) mono\(\$\beta\$ -diketonato\) titanium\(IV\) cationic complexes: Relationships with Calculated Parameters.](#)

s20-046

Bruno A.F. Previdello (IQSC, São Paulo University (USP), Sao Carlos, Brazil), Pablo Fernández, S., Germano Tremiliosi-Filho, Hamilton Varela

[The influence of random superficial defects in Platinum single crystal on the oscillatory electro-oxidation of methanol](#)

Other

s20-047

Nahla Abdelshafi (Environmental Analysis, Bundesanstalt für Materialforschung und -prüfung (BAM), Berlin, Germany), Ulrich Panne, Rudolf Schneider

[Electrochemical Immunosensor for Screening Using Voltammetry](#)

s20-048

Jose Mario Aquino (Chemistry, São Carlos Federal University, São Carlos, Brazil), Isaac José Sánchez Montes, Bianca Ferreira Silva

[A Hybrid Electrochemical and Photochemical Process to Mineralize Tebuthiuron Herbicide](#)

s20-050

Ricardo F. Brocenschi (Chemistry Department, Federal University of São Carlos (UFSCar), São Carlos, Brazil), Peter Hammer, Claude Delouis, Romeu C. Rocha-Filho, Sonia R. Biaggio, Nerilso Bocchi

[Electrochemical Behavior of Boron-Doped Diamond After Electrochemical Pretreatments](#)

s20-051

Robert Hillman (Chemistry, University of Leicester, Leicester, United Kingdom), Marian Perera, Jodie Coulston, Sarah Rose, Karl S. Ryder

[Electroless Metal Deposition as a Means of Visualizing Latent Fingermarks on Metal Surfaces](#)

s20-052

Emily Kerr (Centre for Chemistry and Biotechnology, Deakin University, Geelong, Australia), Egan Doeven, Gregory Barbante, Paul Francis

[Mixed metal chelate annihilation electrogenerated chemiluminescence](#)

s20-053

Ruiter Morais (College of Pharmacy, Federal University of Goiás, Goiânia, Brazil), Kênnia Rezende, Rúbia Machado, Paulo Cesar Ghedini, Eric Gil

[Electrochemical Behavior of Brosimum gaudichaudii Crude Extracts and Their Major Bioactives, Psoralen and Bergapten](#)

s20-054

Masaru Ogasawara (Department of Life Science and Sustainable Chemistry, Tokyo Polytechnic University, Atsugi, Japan), Shohei Suzuki

[Composition Dependence of Physical Constants of Binary Solvent Mixtures](#)

s20-056

Ibeth Rendón-Enríquez (Chemie und Ihre Didaktik, Bergische Universität Wuppertal, Wuppertal, Germany)[Low Cost Electrochromic Windows with Conducting Polymers](#)

s20-057

Katsuhiko Tsunashima (Department of Materials Science, National Institute of Technology, Wakayama College, Wakayama, Japan), Keiichi Nishihata, Kazumasa Honma, Daiki Ito, Yasushi Ono, Masahiko Matsumiya[Design of Phosphonium Ionic Liquids for Electrosynthesis of Conducting Polymers](#)

s20-058

Syed Zohaib Javaid Zaidi (Electrochemical Engineering Laboratory,, Faculty of Engineering and Environment, University of Southampton, Southampton, United Kingdom), Carlos Ponce de Leon, Frank C. Walsh[Sensitive voltammetric analysis of Reactive Black-5 dye by using glassy carbon electrodes](#)

Physical Electrochemistry

s20-059

Tomas Bystron (Department of Inorganic Technology, University of Chemistry and Technology Prague, Prague, Czech Republic), Martin Prokop, Karel Bouzek[Electrochemistry of selected phosphorus oxoacids on a bulk Pt electrode – anodic oxidation and adsorption](#)

s20-060

Jorge D. Gamarra (Electrochemical and Surface Engineering (SURF), Vrije Universiteit Brussel, Brussels, Belgium), Annick Hubin, Tom Hauffman[Chloride free Natural Deep Eutectic Solvents and their use in electrochemistry](#)

s20-061

Mesfin Haile Mamme (Research Group Electrochemical and Surface Engineering, Vrije Universiteit Brussel, Brussels, Belgium), El Amine Mernissi Cherigui, Olga Dolgikh, Jon Ustarroz, Herman Terryn, Johan Deconinck[Numerical Simulation of the Early Stages of the Electrochemical Growth of a Single Nanoparticle in Mixed Water-Acetonitrile Solution](#)

s20-062

Manuel Palomar-Pardavé (Materiales, Universidad Autonoma Metropolitana Azcapotzalco, Mexico City, Mexico), Jorge Mostany, Iván Aldana-González, Luis Botello, Maria Teresa Ramirez-Silva, Mario Romero-Romo, Benjamin Scharifker[Electrochemical Nucleation With Mass Transfer Controlled Growth Under Forced Convection Conditions](#)

Late registrations

s20-063

Omotayo Arotiba (Department of Applied Chemistry, University of Johannesburg, Johannesburg, South Africa), Azeez Idris, John Mafa, Nonhlangabezo Mabuba[A complexometric masking approach in addressing the challenge of Cu\(II\) interference in the electrochemical detection of As\(III\)](#)

Author Index

How to read the Author Index: s08-017 = Poster number
(Thu s13)16:00 = Oral presentation day, symposium, time

A

- Aabloo, Alvo, *s10-039, s10-040*
 Aaboubi, Omar, *s10-079*
 Aaronson, Barak D.B., *s02-077*
 Abaci, Serdar, *s02-048*
 Abakumov, Artem, *s06-013*
 Abbas, Qamar, *s08-006*
 Abbott, Andrew P., *s14-004*
 Abd-El-Latif, A.A., *s06-108, s16-036, s20-007*
 Abdellaoui, Sofiene, *(Tue s03)09:50, s03-001*
 Abdelshafi, Nahla, *s20-047*
 Abderrahmani, Amar, *(Fri 02)09:30*
 Abdi, Abderrezak, *s10-079*
 Abdulazim, T., *(Mon s01)15:00*
 Abdullah Mirzaie, Rasol, *s07-049, s07-050*
 Abel, Bernd, *s07-097*
 Abellán, Alejandra, *s01-040, s01-041*
 Abidat, Ismail, *s07-139*
 Abou-Hassan, Ali, *(Mon s15)10:10*
 Abraham, Bincy George, *s07-051*
 Abrego-Martínez, Juan Carlos, *s07-052, s07-053*
 Achilles, Demetra S., *(Wed s09)09:30, s09-011*
 Achmatowicz, Selim, *s03-058*
 Acosta-Santoyo, Gustavo, *(Tue s11)17:40*
 Acuña-Bedoya, Jawer David, *s11-010*
 Acznik, Ilona, *s08-007, s08-016, s08-017*
 Ad, Elçin, *s20-016*
 Adamiak, Wojciech, *(Thu 20)16:00*
 Adán-Mas, Alberto, *s08-025*
 Addi, Yassine, *s16-016*
 Adly, Nouran, *(Tue s03)16:40*
 Adschiri, Tadafumi, *(Tue s03)09:30*
 Afyon, Semih, *(Mon s06)10:30*
 Aguadero, Ainara, *(Mon s07)17:20*
 Aguilar, Julio C., *s20-004*
 Aguilar, Luis, *s10-097*
 Aguilar, Zaira, *s11-009*
 Aguirre, Juan, *s02-004*
 Ahlberg, Elisabet, *(Mon s11)10:30, (Tue s16)15:20, s11-053*
 Ahmad, Yasser, *(Tue s07)09:50*
 Ahmadi, Kamyar, *(Fri 10)10:10*
 Ahmed Isse, Abdirisak, *s01-001*
 Ahmed, Safeer, *s06-001*
 Ahn, Heejoon, *(Tue s08)17:00*
 Ahn, Sang Hyun, *s07-016*
 Aihara, Yuichi, *(Thu 06)09:50*
 Ainsworth, Emma, *(Tue s03)09:30*
 Akanmu, Sulaiman, *s04-019*
 Akbulut, Hatem, *s06-002*
 Akerele, Oluwatoyin, *s04-019*
 Akerlund, Lisa, *s10-026*
 Akimov, Alexey, *s18-012*
 Akita, Yasuhiro, *s06-113*
 Akter, Rashida, *(Thu 04)15:00*
 Akyüz, Duygu, *s10-078*
 Akyılmaz, Erol, *s20-016*
 Al Sekhaneh, Wassef, *s20-009*
 Al-Hakemy, Ahmed, *s07-106*
 Al-Lolage, Firas, *s03-047*
 Al-Marzoki, K., *(Mon s13)17:20, s13-001*
 Alanís-Valdelamar, Abigail, *s13-002*
 Alar, Vesna, *s13-026*
 Alatorre-Ordaz, Alejandro, *s12-009*
 Albonetti, Cristiano, *(Thu 04)14:40*
 Albrecht, Tim, *(Tue s16)10:10, (Thu 02)16:40, s11-048, s15-025*
 Albu, Mihaela, *s16-032*
 Alcanfor, Ana Aline C., *s14-007*
 Aldana-González, Iván, *s20-033, s20-062*
 Aldave Hernandez, Sandra, *(Fri 02)11:10*
 Alekseyenko, Anastasia, *s07-056, s07-057*
 Algül, Hasan, *s06-002*
 Alias, Yatimah, *s02-052*
 Allahyarov, Elshad, *(Mon s17)17:40*
 Allam, Lamia, *s13-027*
 Allanore, Antoine, *(Mon s11)15:00*
 Almeida, Adriana A., *s20-003*
 Almonacid, Ignacio, *(Fri 07)10:50*
 Aloni, Niv, *s06-003*
 Alp, Ahmet, *s06-002*
 Alsac, Elif Pinar, *s07-015*
 Alsaoub, Sabine, *s03-015*
 Altin, Abdulrahman, *(Tue s13)17:40*
 Altomare, Marco, *s02-063, s02-064*
 Alvarado, Claudia, *s13-022*
 Alvarado, Diego, *s13-022*
 Alvarenga, Gabriel M., *s07-132*
 Alvarez de Eulate, Eva, *(Thu 04)15:00*
 Alvarez Gallego, Yolanda, *s15-011*
 Alvarez-Contreras, L., *s07-054*
 Alvarez-Lueje, Alejandro, *s20-001*
 Alvarez-Malmagro, Julia, *(Wed s03)10:20, s16-048*
 Alvarez-Martos, Isabel, *(Mon s03)18:00, (Thu 04)15:40*
 Alvarez-Pugliese, Christian E., *s11-010*
 Amara, Samia, *s08-004*
 Amati, Matteo, *s16-043*
 Amatore, Christian, *(Mon s15)15:00, (Tue s03)17:20, (Thu 04)17:40, s01-013, s04-030, s20-012*
 Ambolikar, Arvind S., *s02-003*
 Ambriz-Peláez, Oscar, *s07-054*
 Amdouni, Noureddine, *(Mon s06)18:20*
 Amenitsch, Heinz, *(Tue s08)15:40*
 Amin, Hatem M.A., *(Tue s06)15:00*
 Ampudia Castresana, Pablo, *s18-001, s18-028*
 Amriche, S., *s03-051*
 Amstutz, Véronique, *(Thu 20)09:30, (Fri 07)09:30, (Fri 07)11:10*
 An, Junyeong, *s03-020, s05-006*
 Anai, Masatoshi, *s06-141*
 Anand, Mayank, *(Mon s13)14:40*
 Anantram, M.P., *(Mon s03)14:40*
 Anaraki Firooz, Azam, *s02-017, s02-018*
 Anastasescu, Mihai, *s20-015*
 Anderson, Erik, *s16-041*
 Anderson, Marc, *(Fri 07)10:50*
 Ando, Kotomi, *(Tue s07)16:00*
 Andrade, Leandro Helgueira, *s03-037*
 Andreev, Egor, *s03-035*
 Andrei, Mihai, *s13-013*
 Andreu, Rafael, *s03-008, s03-041*
 Andreu, Teresa, *(Fri 18)09:30, (Fri 18)10:10*
 Andronescu, Corina, *(Thu 10)15:00, s07-003, s07-143*
 Anglaret, Eric, *s11-045*
 Angnes, Lucio, *(Tue s01)09:30*
 Anicai, Liana, *s14-002, s14-003*
 Anouti, Mérièm, *s08-004*
 Anquetin, Guillaume, *(Mon s01)17:20*
 Antiochia, Riccarda, *s02-054*
 Antipov, Anatoly, *s07-027, s07-028, s07-034, s17-012*
 Antipov, Evgeny, *s06-013, s06-065, s06-106*
 Antonio, Jadelson L., *(Mon s08)15:20, (Thu 10)16:40*
 Aoki, Masahiro, *(Mon s06)18:00*
 Aoshima, Kazuaki, *s13-015*
 Aouj, Younes, *(Thu 10)16:40*
 Aparicio, Mario, *(Mon s13)17:20, s06-050, s07-102, s13-001*
 Aquilanti, Giuliana, *(Mon s06)17:00*
 Aquino, Jose Mario, *(Tue s11)14:00, s20-048*
 Arçon, Iztok, *(Mon s06)17:00*
 Arai, Hajime, *(Fri 06)11:50*
 Araki, Koiti, *s02-004*
 Araujo, William, *s20-002, s20-011*
 Arbault, Stephane, *(Mon s16)16:00, (Tue s01)17:00, (Tue s03)18:20, (Thu 04)17:20, s02-053*
 Arbiol, Jordi, *s07-003*
 Arbizzani, Catia, *(Fri 06)11:30, s09-017*
 Arce-Estrada, Elsa, *s20-033*
 Arends, Jan, *(Wed s05)10:30, s05-011*
 Arenz, Matthias, *(Tue s07)10:30*
 Aricò, Antonino S., *s07-127*
 Arie, Arenst Andreas, *s08-008*
 Arjona, Noé, *s07-054, s07-101*
 Armijo, Francisco, *s01-032, s03-036*
 Armitstead, Alexander, *s03-031*
 Armstrong, Craig, *s07-029*
 Arnaboldi, Serena, *(Mon s01)15:40, s01-001*
 Arnold, Donna, *(Mon s13)15:00*
 Arnold, Georgiana-Luiza, *s01-050, s15-020*
 Arotiba, Omotayo, *(Thu 02)18:20, s11-033, s11-055, s20-063*
 Arriaga, Gerardo, *s07-052, s07-053, s07-054, s07-101*
 Arrigan, Damien, *(Thu 04)15:00, (Fri 02)11:30*
 Artes Vivancos, Juan Manuel, *(Mon s03)14:40, (Wed s03)09:50, s16-044*
 Artyushkova, Kateryna, *s05-001*
 Artz, Jens, *s07-006*
 Arulrajan, Antony Cyril, *s07-055*
 Asahi, Ryoji, *s18-012*
 Asano, Masato, *s02-013*
 Asensio, Yeray, *s05-003, s05-004*
 Asfaw, Habtom D., *s06-014*

- Aslan, Mesut, (*Mon s08*)15:00, *s08-033*
 Aslanbas, Ozgur, (*Mon s06*)15:00
 Asnavandi, Majid, *s07-002*
 Aspe, Barthelemy, *s06-103*
 Asset, Tristan, (*Tue s07*)17:40,
 (*Fri 07*)10:10
 Astier-Perret, Robin, (*Thu 07*)18:20
 Atanassov, Plamen, (*Tue s03*)15:20,
s05-001, s09-017
 Ateba Mba, Jean-Marcel, (*Thu 06*)17:00
 Athanasiou, Michalis, *s07-100, s11-025*
 Atilir Ozcan, Ayça, *s20-049*
 Atsumi, Ryosuke, *s07-145*
 Attard, Gary, (*Thu 07*)14:00
 Aubert, Pierre-Henri, *s10-102*
 Audebert, Pierre, *s10-088*
 Auer, Alexander, (*Mon s07*)09:50
 Augustyński, Jan, (*Mon s07*)18:00
 Aurbach, Doron, (*Wed s10*)09:30
 Autret, Cecile, *s06-103*
 Avakyan, Leon, *s07-056*
 Aydin, Abdulhamit, *s08-032*
 Ayers, Katherine, (*Wed s19*)09:30
 Azcarate, Iban, (*Thu 10*)15:00
- B**
 Baba, Mamoru, *s06-077*
 Babalola, Oyebamiji, *s11-033*
 Babanova, Sofia, (*Tue s03*)15:20
 Babuchowska, Paulina, (*Mon s08*)18:20
 Bachmann, Bernd, (*Tue s03*)16:40
 Baczyszowski, Dominik, *s07-018*
 Baddour-Hadjean, Rita, (*Fri 06*)11:10
 Badets, Vasilica, *s02-053*
 Bäckström, Joakim, (*Tue s16*)15:20,
s11-037
 Baek, Jaewook, *s04-014*
 Bänziger, Markus, *s11-050*
 Bärtsch, Mario, (*Mon s07*)18:00
 Baeza, Alejandro, *s20-013, s20-014*
 Baffert, Carole, (*Mon s03*)10:10
 Bajdich, Michal, (*Tue s16*)15:00
 Bajracharya, Suman, (*Thu 18*)15:00
 Baker, Darren, *s06-017*
 Baker, Lane, (*Tue s01*)17:20
 Baker, Priscilla, (*Thu 02*)10:30,
 (*Thu 02*)15:40, *s01-038, s01-047,*
s03-002, s04-008, s04-011, s06-025,
s10-102
 Bakierska, Monika, *s06-004*
 Bakker, Eric, (*Tue s01*)16:40
 Balboa, Luis, *s17-004*
 Balderas-Hernandez, Patricia, *s09-013*
 Baldhoff, Tobias, (*Tue s13*)10:30
 Baldim, Victor, *s04-029*
 Baldizzone, Claudio, (*Thu 07*)18:00,
 (*Fri 20*)10:10, *s07-111*
 Baldo, Maria-Antonietta, *s01-016*
 Balducci, Andrea, (*Mon s08*)14:40
 Baleg, Abd Almonam, *s08-012*
 Ballantyne, Andrew, (*Thu 20*)14:20,
s14-004
 Ballauff, Matthias, *s06-114*
 Ballesteros, Luis, *s18-030*
 Balomenou, Stella, *s10-014*
 Bals, Sara, (*Thu 10*)14:00, (*Thu 10*)17:00
 Baltruschat, Helmut, (*Mon s06*)15:40,
 (*Tue s06*)15:00, (*Fri 06*)10:50,
s06-108, s07-019, s16-036, s20-007
- Banasiak, Anna, *s04-025*
 Banda-Alemán, Jorge-Alberto, *s18-013*
 Bandarenka, Aliaksandr, (*Thu 06*)17:40,
s16-012, s20-019
 Bandodkar, Amay, *s01-040*
 Banèie, Tanja, (*Tue s06*)15:20
 Bani Hashemi, Amir, *s20-021*
 Banks, Craig E., *s01-019*
 Bannock, James, *s11-048*
 Bano, Kiran, (*Mon s01*)09:30
 Bao, Yun, *s01-018*
 Baradoke, Austra, *s10-080*
 Barakat, Abdoullatif, *s01-038*
 Baranov, Andrey, *s06-013, s06-065*
 Baranova, Elena, *s16-001*
 Baranton, Stève, (*Thu 20*)14:00, *s07-091,*
s18-003
 Barbante, Gregory, *s01-005, s18-031,*
s20-052
 Barcikowski, Stephan, *s10-008*
 Barde, Henri, (*Wed s19*)10:10
 Bardenhagen, Ingo, (*Thu 06*)14:20,
 (*Fri 06*)11:10
 Barek, Jiří, *s03-055*
 Barile, Christopher, (*Mon s16*)16:40
 Barlog, Martin, *s15-041*
 Barpanda, Prabeer, (*Wed s06*)09:50,
s06-005
 Barraco, Daniel, *s06-041, s06-042,*
s06-051, s06-052
 Barragan, José, *s10-092*
 Barraza Burgos, Juan Manuel, *s11-010*
 Barrera, Joaquin, (*Tue s01*)16:00
 Barrio, Joaquín, *s20-009*
 Barros, Caroline de Faria, (*Mon s13*)09:50
 Barsan, Madalina, (*Thu 10*)14:20, *s10-029*
 Bartlett, Philip, (*Tue s16*)16:40, *s03-047*
 Bartolini, Luca, (*Thu 04*)14:40
 Barton, Zachary, (*Mon s16*)10:30
 Bartosik, Martin, (*Thu 04*)15:20
 Barwe, Stefan, (*Mon s01*)16:00,
 (*Thu 10*)15:00, *s07-003*
 Barylyak, Adriana, *s06-027*
 Basak, Shibabrata, (*Tue s01*)14:40
 Basile, Andrew, *s06-083*
 Bastide, Stéphane, (*Thu 10*)14:40, *s10-056*
 Batanero, Belen, *s15-001*
 Batchelor-McAuley, Christopher, *s02-006*
 Batisse, Nicolas, (*Tue s07*)09:50
 Batista Deroco, Patricia, *s02-019*
 Batista, Elisete A., *s07-132*
 Battaglia, Corsin, *s10-058*
 Battaglia, V., (*Tue s06*)14:20
 Battistel, Alberto, (*Thu 20*)09:30,
 (*Fri 07*)09:30
 Bayati, Maryam, *s07-004*
 Bayer, Bernhard C., (*Thu 16*)09:30
 Bazant, Martin Z., (*Mon s17*)16:40,
 (*Thu 12*)18:20
 Beall, Edward, (*Mon s03*)15:00
 Bechelany, Mikhael, *s09-012*
 Becker-Steinberger, Katharina,
 (*Thu 06*)15:20, *s06-131*
 Bedioui, Fethi, *s03-051, s04-029, s18-002*
 Béguin, François, (*Mon s08*)10:10,
 (*Mon s08*)18:20, (*Tue s08*)15:00,
s08-001, s08-006, s08-009
 Behm, R. Jürgen, (*Tue s16*)14:00, *s02-070*
 Behnken, Julian, (*Thu 07*)10:10
- Beladi Mousavi, Seyyed Mohsen, *s10-054*
 Bele, Marjan, (*Fri 07*)11:30, *s10-015*
 Belenov, Sergey, *s07-056, s07-057*
 Belhadj, Mariem, *s07-058*
 Belin, Stéphanie, (*Tue s08*)14:20
 Belkhalifa, Hakim, (*Fri 02*)09:30
 Bell, Alexis T., (*Fri 18*)11:30
 Belova, Alina, *s16-043*
 Belsky, Petr, *s12-010*
 Benaoudia, Dihia, (*Mon s01*)17:20
 Benbrahim, Nassima, *s10-042, s13-021*
 Benchettara, Abdelhakim, *s02-078*
 Benchettara, Abdelkader, *s02-078*
 Bendikov, Tatyana B., (*Fri 10*)11:10
 Benedetti, Tânia, *s10-027, s10-048*
 Benfedda, Baya, *s10-042*
 Benfer, Sigrid, (*Fri 13*)09:30
 Benincori, Tiziana, (*Mon s01*)15:40
 Bentley, Cameron, *s01-002, s01-008*
 Bera, Bapi, *s07-140*
 Berbec, Sylwia, (*Thu 20*)18:20
 Berestenko, Victor, *s06-015*
 Berg, Erik J., (*Tue s08*)10:30,
 (*Tue s06*)18:00, *s16-022*
 Berger, Daniel, *s16-054*
 Berggren, Magnus, *s08-003*
 Bergmann, Arno, (*Mon s07*)09:30,
 (*Mon s07*)10:10, *s07-059*
 Bergmann, Henry, (*Tue s11*)17:20, *s11-011*
 Bergna, Davide, *s07-122*
 Bermejo-Gerardo, Carlos M., *s20-004*
 Berna Galiano, Antonio, (*Mon s16*)14:00
 Bernard, Laurent, (*Mon s06*)17:40
 Bernardes, Andréa M., *s11-034*
 Bertani, Federico, *s15-037*
 Berthon-Fabry, Sandrine, (*Tue s07*)09:50
 Bertin, Erwan, *s18-019*
 Bertinello, Paolo, (*Fri 02*)11:10
 Bertotti, Mauro, *s02-004, s20-017*
 Besaha, Khrystyna, *s06-027*
 Besra, Laxmidhar, (*Tue s14*)16:40
 Bessegato, Guilherme, *s02-060*
 Best, Robert, (*Mon s03*)10:10
 Betancourt, I., *s07-128*
 Bezverkhy, Igor, (*Fri 10*)10:50
 Biaggio, Sonia R., (*Tue s11*)14:00,
s10-001, s20-003, s20-050
 Bian, Yanhong, (*Tue s09*)10:10
 Bianchini, Mattéo, (*Thu 06*)17:00
 Bianco, Stefano, *s16-049*
 Biavardi, Elisa, *s15-037*
 Bieberle-Hütter, Anja, *s02-061*
 Biedermann, P. Ulrich, *s17-001*
 Bienkowski, Krzysztof, *s18-006*
 Biesheuvel, Maarten, (*Tue s09*)14:00,
 (*Tue s09*)16:00, (*Tue s09*)18:20,
 (*Thu 09*)10:10, *s09-004, s09-006,*
s17-011
 Biglé, Pascal, *s03-051*
 Bigos, Agnieszka, (*Mon s13*)14:00
 Bilewicz, Renata, (*Mon s03*)16:00, (*Wed*
s03)10:30, (*Thu 04*)18:00, *s03-019,*
s03-026, s04-013
 Biller, Agnès, *s08-004*
 Binti Mohammed Batcha, Abeer Fatima,
s02-007
 Birdja, Yuvraj Y., (*Mon s16*)15:40,
s15-029, s16-007, s18-018
 Birzan, Liviu, *s01-050, s15-020*

- Bisang, José M., *s11-001, s11-015, s11-049*
 Bischoff, Rainer, (*Mon s01*)18:00, *s15-006*
 Bisselink, Roel, *s11-012, s11-013*
 Bitenc, Jan, (*Tue s06*)15:20
 Biyikli, Necmi, *s06-092*
 Biyiklioglu, Zekeriya, *s10-099*
 Bizzotto, Dan, (*Mon s16*)09:30, *s03-028*
 Björefors, Fredrik, (*Mon s06*)14:40,
*(Tue s06)*10:10, *s06-024*
 Blanchard, Sebastien, *s18-002*
 Blanda, Giuseppe, *s04-020*
 Blanga, Raymond, (*Tue s06*)14:00
 Blart, Eroid, (*Thu 06*)15:40
 Blatov, Vladislav A., (*Fri 06*)11:50
 Blawert, Carsten, (*Mon s13*)18:00
 Blidberg, Andreas, (*Tue s06*)10:10
 Blout, Achraf, *s03-016*
 Blumberger, Jochen, (*Mon s03*)10:10
 Bobacka, Johan, *s01-012*
 Bobes Limenes, Pablo, *s03-043*
 Bobitski, Jaroslav, *s06-027*
 Bobrowski, Tim, *s03-017*
 Boccaccini, Aldo, *s14-015, s14-017*
 Bocchi, Nerilso, (*Tue s11*)14:00, *s20-003,*
s20-050
 Böhme, Solveig, *s06-006*
 Boeva, Zhanna, *s03-052*
 Bograchev, Daniil, *s20-042*
 Bohlen, Barbara, *s02-020*
 Bohn, Paul, (*Wed s02*)10:10
 Boillat, Pierre, (*Mon s07*)14:20
 Boissou, Florent, (*Thu 20*)14:00, *s18-003*
 Boivin, Edouard, (*Thu 06*)17:00
 Bolat, Gulcin, *s02-021, s02-048*
 Bollella, Paolo, *s02-054*
 Bollo, Soledad, *s02-001*
 Boltalina, Olga V., *s15-042*
 Bolzan, Agustin E., *s02-022*
 Bomer, Johan, (*Mon s01*)18:00
 Bonastre, Alex, *s02-036*
 Bonazza, Gregorio, (*Tue s01*)10:10
 Bonchio, Marcella, (*Fri 10*)10:10
 Bond, Alan M., *s01-002, s01-008, s04-004,*
s17-013
 Bondue, Christoph, (*Mon s06*)15:40,
*(Fri 06)*10:50
 Bonfim, Carolina, *s03-018*
 Boni, Alessandro, (*Fri 10*)10:10, *s10-022,*
s15-030
 Bonnefont, Antoine, (*Thu 07*)18:00,
s07-116, s07-144, s10-024, s10-025
 Bonnet, Caroline, (*Thu 12*)16:00, *s07-060*
 Bonneux, Gilles, *s06-082*
 Bonthuis, Douwe Jan, (*Mon s17*)18:00
 Boon-Brett, Lois, (*Thu 12*)15:20, *s06-039,*
s06-040, s06-058
 Bordet, Pierre, (*Tue s07*)17:40,
*(Fri 07)*10:10
 Borghei, Maryam, *s07-014*
 Borisov, Sergey, (*Thu 06*)17:20
 Borowicz, Pawel, (*Mon s03*)17:00
 Borsa, Dana M., *s06-107*
 Boshnakova, Iveta, *s07-005*
 Botello, Luis, *s20-033, s20-062*
 Bott-Neto, Jose L., (*Thu 07*)17:40
 Bottari, Fabio, *s01-027, s16-017*
 Bottin, Hervé, (*Mon s03*)10:10
 Botz, Alexander J.R., *s02-002, s03-059,*
s07-089
 Bouali, Anissa, (*Tue s13*)17:20
 Bouckennoog, Pieter, (*Thu 10*)17:00
 Boudinar, Salem, *s10-042*
 Boudjoui, Selim, *s01-038*
 Bouffier, Laurent, (*Mon s16*)16:00,
*(Tue s03)*18:20, (*Thu 10*)10:10
 Boughrara, Dalila, *s13-021*
 Boukherroub, Rabah, (*Fri 02*)09:30
 Boulanger, Clotilde, *s11-002*
 Boutarfaia, Slimane, *s13-021*
 Bouwman, Elisabeth, *s15-026*
 Bouwman, Peter, (*Thu 12*)17:40
 Bouzek, Karel, (*Mon s11*)14:00,
*(Mon s11)*14:40, (*Tue s11*)10:10,
s07-067, s12-010, s20-059
 Brachetti-Sibaja, Silvia B., *s13-002*
 Bragato, Carlo, (*Tue s01*)10:10
 Brancoveanu, Oana, *s14-003*
 Brandell, Daniel, (*Mon s06*)14:40
 Brandenburg, Gerlinde, *s13-005*
 Brandon, Nigel, (*Thu 07*)15:40,
*(Thu 12)*15:40
 Brankovic, Stanko, (*Fri 10*)10:10
 Braun, Stefanie, (*Thu 06*)15:20, *s06-131*
 Bravo Anaya, Lourdes Mónica,
*(Mon s03)*15:20
 Bravo, Manuel, *s10-097*
 Bresme, Fernando, (*Mon s17*)10:10
 Bresser, Dominic, (*Mon s06*)17:40
 Bressers, Peter, (*Thu 10*)16:40
 Brett, Christopher, (*Thu 10*)14:20, *s10-029*
 Brett, Dan, (*Mon s07*)16:40, *s07-105,*
s07-112
 Breugelmanns, Tom, (*Thu 10*)14:00,
*(Thu 18)*17:00, *s11-032, s15-036,*
s18-025, s20-036
 Briega-Martos, Valentín, (*Mon s16*)18:00,
s16-002
 Brillas, Enric, (*Tue s11*)15:40
 Brimaud, Sylvain, (*Tue s16*)14:00, *s02-070*
 Brisset, François, (*Thu 20*)15:20
 Brister, Bryan, (*Tue s09*)15:20
 Brito, Juliana Ferreira, *s18-007*
 Brocenschi, Ricardo F., *s01-025, s20-003,*
s20-050
 Broicher, Cornelia, *s07-006*
 Brosseau, Christa, (*Tue s01*)17:40
 Brotons Cuevas, Ariadna, *s01-019,*
s01-020
 Brousse, Thierry, (*Mon s08*)10:10,
*(Mon s08)*15:40, (*Tue s08*)14:20,
s08-009
 Broux, Thibault, (*Thu 06*)17:00
 Brucato, Valerio, *s04-020*
 Brudzisz, Anna, (*Fri 10*)09:50, *s10-043*
 Brüning, Frank, *s11-045*
 Brunklaus, Gunther, *s10-034*
 Bruns, Michael, *s07-039*
 Brushett, Fikile, *s07-042*
 Brzostek, Katarzyna, *s03-009*
 Brzózka, Agnieszka, (*Tue s08*)14:40,
*(Fri 10)*09:50, *s10-043*
 Brzozowska, Kamila, *s16-005*
 Bucher, Christophe, (*Thu 10*)15:00,
s11-050
 Buchholz, Daniel, (*Mon s06*)15:20,
*(Tue s06)*17:20, *s06-097*
 Budnikov, Herman, *s01-031, s01-051*
 Buechi, Felix, *s07-083*
 Bülter, Heinz, *s06-074, s06-081*
 Buesen, Darren, (*Tue s03*)14:40, *s03-005,*
s17-006
 Buess-Herman, Claudine, *s14-012,*
s16-030, s18-014
 Bugaev, Lusegen, *s07-056*
 Buica, George-Octavian, *s01-050, s15-020*
 Buisman, Cees, (*Thu 18*)15:00
 Bujewska, Paulina, (*Tue s08*)15:00,
s08-001
 Bukovsky, Eric V., *s15-042*
 Buleandra, Mihaela, *s04-003*
 Bullions, Erin, (*Tue s14*)15:00
 Bund, Andreas, *s06-027, s06-047, s16-024*
 Burgess, Mark, (*Mon s16*)10:30,
*(Thu 10)*15:40
 Burgos, Ana, *s10-045, s10-055, s18-011*
 Burheim, Odne, (*Thu 07*)14:00
 Burian, Max, (*Tue s08*)15:40
 Buriez, Olivier, (*Mon s15*)15:00, *s01-013*
 Burn, P.L., *s18-031*
 Buron, Cédric, (*Tue s14*)17:20
 Bustos, Erika, (*Tue s11*)17:40, *s11-014*
 Butler, Sue M., (*Tue s08*)09:30
 Butt, Julea, (*Tue s03*)09:30
 Buvat, Gaëtan, (*Mon s08*)15:40,
*(Tue s08)*14:20
 Buzzetti, Paulo, (*Wed s13*)10:10
 Bystron, Tomas, (*Mon s11*)14:40,
*(Tue s11)*10:10, *s12-010, s20-059*
- ## C
- Cabanova, Varvara, (*Thu 10*)16:00
 Cabello, Gema, *s10-001*
 Cabeza, Oscar, *s06-026*
 Cabot, Andreu, (*Fri 18*)10:10
 Cabral, Diogo, (*Thu 20*)14:40
 Cachet-Vivier, Christine, (*Thu 10*)14:40,
s10-056
 Cador, Olivier, (*Fri 07*)11:30
 Cai, Qiong, *s06-100, s07-098*
 Cai, Zhuang, *s02-062*
 Calderon Moreno, Jose Maria, *s13-013*
 Calle-Vallejo, Federico, (*Tue s16*)14:20,
s16-004, s16-013, s17-005
 Callejas-Chavero, Alicia, *s11-014*
 Calvente, Juan José, *s03-008, s03-041*
 Calvi, Felipe, *s09-008*
 Calvillo, Laura, (*Mon s07*)17:20
 Calvo, Ernesto Julio, (*Wed s09*)10:10
 Camara, Giuseppe Abiola, *s16-008*
 Cámara, Osvaldo, *s06-042*
 Cambaz, Musa Ali, *s06-007, s06-008*
 Camero, Carlos, (*Tue s09*)15:20
 Campuzano, Susana, (*Thu 04*)14:00
 Canales, Camila, *s07-061*
 Canals, Antonio, *s01-040, s01-041*
 Cañas, Natalia A., *s06-114*
 Cañizares, Leonor, (*Tue s11*)16:00
 Cañizares, Pablo, (*Tue s11*)10:30,
*(Tue s11)*16:00, (*Tue s11*)17:00,
s05-003, s05-004, s11-008, s11-038,
s11-042, s20-040
 Cannes, Céline, (*Thu 20*)15:20
 Cano, Irene Garcia, *s11-022*
 Cao, Dianxue, *s02-073*
 Cao, Xiao-Yu, (*Mon s16*)10:10
 Cao, Yiqi, *s06-023*
 Cao, Zhenming, *s07-137*

- Carbonio, Emilia A., *s07-073*
 Cárdenas, Jesús, *s11-014*
 Cardoen, Dennis, (*Thu 09*)09:30
 Cardoso, Eduardo S.F., (*Fri 20*)11:10
 Carfi Pavia, Francesco, *s04-020*
 Cargnello, Matteo, (*Fri 10*)10:10
 Carla, Francesco, *s16-010, s20-030*
 Carminati, Marco, (*Thu 02*)16:40
 Carmo, Marcelo, *s07-022*
 Carnelli, Lino, *s07-043*
 Carreño-Aguilera, Gilberto, *s09-014*
 Carrillo-Abad, Jordi, *s11-004*
 Carta, Mariolino, *s02-011, s02-032, s02-077*
 Carvalho de Almeida, Camila, (*Tue 11*)15:00
 Casanova-Moreno, Jannu, (*Mon 16*)09:30
 Casciano, Paulo, *s13-010*
 Cassidy, John, *s04-025*
 Castañeda, Erick, *s03-036*
 Castanheira, Luis, (*Mon 09*)16:40
 Castaño-Meneses, Gabriela, *s11-014*
 Castro, María P., (*Tue 11*)16:00
 Castro, Suely, *s02-055*
 Castro, Yolanda, (*Tue 14*)18:20
 Catalano, Jacopo, (*Thu 09*)10:10
 Catano, Francisco, *s10-045*
 Catarelli, Samantha, (*Thu 16*)10:10
 Cattarin, Sandro, (*Thu 10*)17:20, (*Thu 10*)17:40
 Cattiaux, Laurent, (*Mon 15*)15:00
 Causin, Valerio, *s07-074*
 Causserand, Christel, (*Tue 11*)14:40
 Cazayus, Emmanuelle, *s07-139*
 Cea, Pilar, (*Thu 16*)10:10
 Celedón, Carlos, *s18-030*
 Celiesiute, Raimonda, *s10-086*
 Celorrio, Veronica, (*Mon 07*)17:20
 Ceppi, Sergio, *s06-052*
 Cerdá, María Fernanda, *s20-018*
 Cerdán Pasarán, Andrea, *s12-009*
 Cermenek, Bernd, *s07-084*
 Cernat, Andrea, *s02-023*
 Cerri, Isotta, (*Thu 07*)18:20, *s10-068*
 Cetinkaya, Tugrul, *s06-002*
 Cha, Gihoon, *s02-063, s02-064, s06-054*
 Chacón, Joaquín, (*Fri 06*)11:30
 Chae, Munseok, *s06-119*
 Chai Mei Yi, Rosalie, (*Mon 13*)18:20
 Chainet, Eric, *s10-042*
 Challier, Lylian, *s01-013*
 Chan, Candace, *s06-009, s06-132*
 Chan, Karen, (*Tue 16*)15:00
 Chan, Ya Yun, *s02-050*
 Chancelier, Léa, (*Fri 07*)11:30
 Chandesris, Marion, (*Mon 07*)14:00
 Chanéac, Corinne, *s07-139*
 Chang, In Seop, *s05-006*
 Chang, Lee-Tian, *s04-024*
 Chang, Min-Chao, *s09-023*
 Chang, Won-seok, *s06-123*
 Chang, Yi-feng, (*Thu 02*)17:40
 Chang, Yunzhen, *s14-001*
 Changguo, Chen, *s16-003*
 Chapples, John, *s10-093*
 Chardon-Noblat, Sylvie, (*Fri 18*)10:50
 Chatenet, Marian, (*Tue 07*)09:50
 Chatta, Hadjer, *s11-047*
 Chattot, Raphael, (*Tue 07*)09:50, (*Fri 07*)10:10
 Chauque, Susana, *s06-042, s06-051*
 Chauvet, Fabien, (*Tue 11*)18:20, *s11-024*
 Chazaro-Ruiz, Luis F., *s10-096*
 Che Ani, Aini Suzana, *s10-095*
 Chekannikov, Andrey, *s06-096, s06-104*
 Chen, Chang-Chih, *s11-026, s13-003, s14-006, s14-014*
 Chen, Chang-Hui, *s16-025*
 Chen, Chen, *s02-080*
 Chen, Chunguang, *s06-109*
 Chen, Dejun, (*Mon 16*)15:20, (*Tue 16*)09:30
 Chen, Fangfang, (*Tue 06*)09:30
 Chen, G., (*Tue 06*)14:20
 Chen, George Zheng, (*Mon 08*)14:00
 Chen, Hayan, (*Thu 06*)17:00
 Chen, Hong-Yuan, (*Mon 01*)18:20
 Chen, Hui, *s01-036*
 Chen, Jian, *s06-134, s06-135*
 Chen, Jun, (*Tue 08*)17:40, *s06-086*
 Chen, Kun, *s14-005*
 Chen, Leanne D., (*Tue 16*)15:00
 Chen, Liang, *s06-115*
 Chen, Long, *s07-046*
 Chen, Lu, (*Fri 18*)11:50, *s18-021*
 Chen, Qiaoli, *s07-137*
 Chen, Rui, *s20-037*
 Chen, Ruiyong, *s06-010, s07-030*
 Chen, Sharon, *s07-124*
 Chen, Shougang, *s13-018*
 Chen, W., (*Tue 06*)14:20
 Chen, Wei, *s15-040*
 Chen, Weiping, *s06-023, s18-038*
 Chen, Xiaoting, *s16-004, s16-013*
 Chen, Xue-Jiao, *s18-008*
 Chen, Yan, (*Mon 13*)18:00
 Chen, Yan-Xia, (*Mon 16*)17:40, *s15-040*
 Chen, Yaqin, *s06-073*
 Chen, Yi An, *s09-001*
 Chen, Yi-Lin, *s12-001*
 Chen, Yuhui, (*Fri 06*)10:10
 Chen, Zhaoyang, *s07-093*
 Chen, Zhi-Xin, *s15-031*
 Chen, Zhi-Xing, *s07-133*
 Chen, Zhi-Yong, *s15-031*
 Chenard, Etienne, (*Thu 10*)15:40
 Cheng, Kevin J., (*Thu 10*)15:40, *s07-042*
 Cheng, Qian, *s06-009*
 Cherevko, Serhiy, (*Tue 07*)09:30, (*Thu 07*)16:40, *s07-022, s07-090, s07-111, s10-004*
 Cherigui, El Amine Mernissi, (*Thu 10*)17:00, *s20-061*
 Chernev, Petko, (*Mon 07*)10:10, (*Tue 07*)16:40
 Chery, Déborah, *s07-141*
 Chetty, Raghuram, *s07-051*
 Chevance, Soizic, (*Thu 20*)15:00
 Chi, Qijin, (*Mon 03*)09:30, (*Wed 02*)09:50, (*Fri 10*)11:50, *s10-090, s18-035*
 Chi, Yu-Wen, (*Tue 08*)14:00
 Chianca de Moura, Dayanne, *s16-037*
 Chiarotto, Isabella, *s15-002, s15-003*
 Chihara, Kuniko, *s06-110*
 Chisaka, Mitsuharu, *s07-062*
 Chiwata, Morio, (*Fri 07*)10:50
 Cho, Jang-Hyeon, *s20-020*
 Cho, Kangwoo, (*Fri 20*)11:50
 Cho, Misuk, *s02-068, s02-069, s07-017*
 Cho, Woosuk, *s06-011*
 Cho, Young-Sang, *s06-021*
 Choe, Hui-Seon, *s10-064, s10-065*
 Choi, Chang Hyuck, (*Thu 10*)14:20, *s07-063*
 Choi, Changhoon, *s06-087*
 Choi, Hong Soo, *s06-123*
 Choi, Hyeonji, *s07-109*
 Choi, In-Ae, *s10-062*
 Choi, Jongrak, *s12-008*
 Choi, Samgwon, *s06-111*
 Choi, Yusong, *s06-133, s20-024, s20-025*
 Chong, Meng Nan, (*Tue 14*)15:20
 Chong, Pohere, *s11-024*
 Chorkendorff, Ib, (*Mon 16*)15:00, (*Tue 07*)17:20, *s16-012*
 Chot, Chun Yuan, (*Tue 14*)15:20
 Chotard, Jean-Noel, (*Thu 06*)17:00
 Chou, Shu-Wei, *s08-035*
 Choudhury, Soumyadip, (*Tue 08*)15:20
 Choun, Myoungsoon, *s07-031, s07-064*
 Christensen, Rune, (*Mon 17*)18:20
 Christoph, Grimmer, *s07-138*
 Chu, Y. Q., *s07-093*
 Chuang, Chung-Hsien, (*Fri 06*)09:30, *s08-026*
 Chung, Hoon T., (*Tue 07*)14:20
 Chung, Li-Ching, *s09-023*
 Chung, Sangho, *s09-005*
 Chung, Taek Dong, (*Thu 04*)10:10
 Ciccarella, Pietro, (*Thu 02*)16:40
 Cid-Ceron, Marlene, *s01-022*
 Cieplak, Maciej, (*Mon 03*)17:00
 Cierpka, Christian, *s07-018*
 Cincotto, Fernando, *s02-042*
 Ciucci, Francesco, *s16-034*
 Ciucu, Anton, *s04-003*
 Ciui, Bianca, *s03-056*
 Cizkova, Martina, (*Mon 15*)15:00
 Claireaux, Vincent, (*Thu 20*)15:00
 Clancy, Tomás, *s06-057*
 Clarke, Tomos J., *s02-011*
 Clausmeyer, Jan, *s01-017, s02-002, s03-059, s04-031*
 Clayton da Silva, Aruã, *s03-037*
 Cleemann, Lars N., (*Tue 07*)14:40
 Clikeman, Tyler T., *s15-042*
 Climent Paya, Victor, (*Mon 16*)14:00
 Coban, Kivanc, *s06-084*
 Cochet, Magali, (*Mon 07*)14:20
 Coelho dos Santos, Mauro, *s02-044*
 Coetsier, Clémence, (*Tue 11*)14:40
 Cohen, Hagai, *s09-002*
 Cojocar, Anca, *s14-002*
 Cojocar, Paula, *s10-046*
 Coledam, Douglas A.C., (*Tue 11*)14:00, *s20-003*
 Colina, Alvaro, (*Mon 15*)14:40, (*Tue 01*)15:40, (*Tue 01*)16:00, *s02-031, s02-035*
 Colleran, John, *s04-025*
 Collet, Thomas, *s07-069*
 Colli, Alejandro N., (*Thu 20*)09:30, *s07-032, s11-015*
 Collins, Martha, *s01-033*
 Coltrin, Michael, *s11-046*
 Combellas, Catherine, (*Mon 15*)10:10,

- (Thu 10)18:00
 Comisso, Nicola, (Thu 10)17:20,
 (Thu 10)17:40
 Comminges, Clément, s07-139
 Compain, Jean-Daniel, (Thu 10)15:00,
 (Fri 18)10:50, s10-057
 Company, Ximo, s20-008
 Compton, Richard G., s02-006, s20-035
 Connolly, Liam, (Thu 07)14:00
 Conradie, Jeanet, s20-044, s20-045
 Conti, Fosca, s20-006
 Conzuelo, Felipe, (Tue s03)10:10,
 (Tue s03)14:40, (Fri 20)09:30,
 s03-015, s03-022, s03-056
 Cooray, M.C. Dilusha, s04-004
 Coote, Michelle, (Tue s03)15:00
 Cordoba de Torresi, Susana,
 (Mon s08)15:20, (Thu 10)16:40,
 s03-037, s10-048
 Córdoba, Ricardo, s10-050, s10-097
 Coreño, Oscar, s11-009
 Coria, Gabriela, s11-016
 Cornell, Ann, (Mon s11)09:30, s06-035,
 s11-037
 Corona-Avenidaño, Silvia, s01-022
 Correa, Alessandra, s02-041
 Corrêa, Cíntia, s10-027
 Correa, Matheus, s01-048
 Correia, Adriana, s02-055, s13-010,
 s14-007, s16-018
 Corres, Ma. Ángeles, (Tue s14)18:00
 Cosnier, Serge, s10-088
 Costa Bassetto, Victor, s07-092
 Costa, Paulo R., (Tue s15)10:30
 Costenoble, Sandrine, s13-011
 Costovici, Stefania, s14-003
 Cotarta, Adina, s14-002
 Cotillas, Salvador, (Tue s11)10:30,
 (Tue s11)16:00, s11-042, s20-040
 Coulston, Jodie, s20-051
 Coutanceau, Christophe, (Thu 20)14:00,
 s07-091, s18-003
 Cox, Liam, (Thu 03)10:10
 Crespo, Gaston, (Tue s01)10:30,
 (Tue s01)16:40
 Crespy, Daniel, (Wed s13)10:30
 Cretin, Marc, s09-012
 Crispin, Xavier, s08-003
 Cristea, Cecilia, s02-023, s02-049,
 s03-053, s03-056, s04-005, s10-029
 Crittenden, Deborah, (Thu 10)18:20
 Croce, Fausto, s06-048
 Croguennec, Laurence, (Thu 06)17:00
 Cromhout, Mary, s04-007
 Crosnier, Olivier, (Mon s08)10:10,
 (Mon s08)15:40, (Tue s08)14:20,
 s08-009
 Crowley, Peter, s03-006
 Cruz, Yenny, s11-014
 Csepei, Lenard-Istvan, s18-026
 Cuartero, Maria, (Tue s01)16:40
 Cuenya, Beatriz Roldan, (Thu 07)18:20
 Cuevas-Muñiz, Francisco Mherande,
 s07-052, s07-053
 Cui, Fangming, (Fri 06)09:50
 Cui, Jin, (Mon s01)14:20
 Cysewska, Karolina, s04-015
D
 D'Angelo, Adriana, (Mon s11)17:00,
 s11-040
 D'Anna, Francesca, s15-002
 d'Orlyé, Fanny, s04-029
 D'Souza, Francis, (Mon s03)17:00
 da Costa Soares, Izabelle Cristina, s11-028
 da Silva Antonin, Vanessa, s02-044
 da Silva, Bianca F., (Tue s11)14:00
 da Silva, Djalma R., s11-020, s11-021
 da Silva, Elton Clementino, s04-027
 Da Silva, Everson, s10-092
 da Silva, Gabriel, s16-008
 Da Silva, Rodrigo, s07-065
 da Silva, Salatiel W., s11-034
 Daasbjerg, Kim, s18-010
 Daems, Nick, (Thu 07)17:40
 Dai, Chao-Shuan, s08-035
 Dai, Juan, s06-076
 Daimon, Hideo, (Fri 07)09:30
 Dal Santo, Vladimiro, s10-011, s16-014
 Dalcanele, Enrico, s15-037
 Dalchiale, Enrique, s10-087
 Daletou, Maria, s07-107
 Dalglish, Robert, (Tue s16)16:00
 Dalkiran, Berna, s10-089, s10-091
 Dallavalle, Marco, (Thu 04)14:40
 Damas, Christine, s06-103, s08-040,
 s08-041
 Damaskin, Boris, s16-019
 Damlin, Pia, s08-028, s10-084
 Dang, Truong Ka My, (Tue s03)16:40
 Dann, Ellie, (Mon s07)17:20
 Danner, Timo, (Thu 06)15:20, s06-124
 Darvishzad, Termeh, s01-042, s01-052
 Das, Sayantan, s10-044
 Dau, Holger, (Mon s07)10:10,
 (Tue s07)16:40
 David, Rénaud, (Thu 06)17:00
 Davidi, Guy, (Mon s06)16:40
 Dávila, Martín, s11-017
 Davodi, Fatemeh, s07-014
 Davoglio, Rogério A., s10-001
 Davydov, Alexey, s20-039, s20-041,
 s20-042
 De Andrade, Adalgisa, s03-018, s07-065
 De Bon, Francesco, s15-004
 de Freitas Araujo, Karla Caroline, s11-028
 De Gendt, Stefan, (Wed s10)10:10
 de Groot, Thijs, (Mon s11)09:50, (Wed
 s19)10:30
 de Haart, L.G.J., (Mon s16)14:20,
 (Mon s06)15:00, s06-019, s10-023
 de Jong, Mats, (Mon s03)18:20, s03-060
 de Klerk, Robert, (Tue s09)14:00
 de Klerk, Niek, (Thu 12)18:20
 de Kruijff, Goswinus, s15-019
 De la Rosa, Elder, s12-009
 De la Rosa, Miguel A., s03-041
 De Lacey, Antonio L., (Mon s03)10:30,
 s03-003
 de Leeuw, Nora H., s18-037
 de Lima, Maycon Douglas, s11-021
 De Lima-Neto, Pedro, s14-007, s16-018
 de Oliveira Neto, Jerônimo Raimundo,
 s04-028
 De Peuter, Senne, (Thu 09)09:30
 de Poulpique, Anne, (Tue s03)18:20
 de Sancho, David, (Mon s03)10:10
 de Sanoit, Jacques, (Thu 20)15:20
 de Smet, Louis, s03-033
 de Souza, Nyccolas Emanuel,
 (Tue s16)09:50
 de Vasconcelos, Camila C., (Tue s15)10:30
 de Vooyo, Arnoud, (Mon s11)10:10
 De Wael, Karolien, (Mon s03)18:20,
 s01-027, s01-034, s03-060, s10-100,
 s11-032, s16-017
 de-los-Santos-Álvarez, Noemí,
 (Mon s03)15:40
 de-Santiago, Adrian, s20-013, s20-014
 Debate, Stéfano, (Thu 07)14:40
 Deconinck, Johan, s07-069, s20-061
 Décoppet, Jean-David, s20-018
 Dedigama, Ishanka, (Mon s07)16:40
 Degnah, A., (Mon s13)17:20, s13-001
 Deiss, Frédérique, s01-014, s04-006
 del Pozo, Maria, (Wed s09)10:10
 del Rio, C., s07-102
 del Valle, Maria Angelica, s01-032,
 s03-036
 Delalande, Olivier, (Thu 20)15:00
 Delices, Annette, (Thu 10)17:40
 Delouis, Claude, s20-050
 Delvaux, Adeline, s07-066
 Dembinska, Beata, s16-005
 Dementin, Sébastien, (Thu 18)14:40
 Demetrescu, Ioana, s13-013
 Demir-Cakan, Rezan, s06-098, s06-099
 Dennison, Christopher Raymond,
 (Thu 20)09:30, (Fri 07)09:30
 Denuault, Guy, (Mon s16)17:20,
 (Fri 20)11:30, s02-010
 Derr, Igor, (Wed s07)09:30, s07-033
 Desta Asfaw, Habtom, (Wed s06)09:30
 Destro, Matteo, s06-058
 Detavernier, Christophe, s06-082
 Deunf, Elise, (Mon s08)10:10,
 (Thu 06)15:40
 Devadoss, Anitha, s03-063
 Devillers, Charles H., s10-037, s15-010
 Devivaraprasad, Ruttala, s10-047
 Dewilde, Silvia, (Mon s03)18:20
 Deya, Cecilia, s13-006
 Deyu, Fang, s01-023
 Dheda, Keertan, s04-011
 Dhiman, Rajnish, s06-012
 Di Bari, Chiara, s03-003, s03-017
 Di Franco, Francesco, (Tue s13)16:40,
 s07-117
 Di Persio, Franco, s06-040
 Di Pisa, Margherita, s01-013
 Di Quarto, Francesco, (Tue s13)16:40,
 s07-117
 Di Sarli, Alejandro R., s13-006
 Diacu, Elena, s01-050
 Dias, Diego F., s13-010, s14-007
 Diaz-Morales, Oscar, (Mon s07)17:40
 Díaz-Quintana, Antonio, s03-041
 Diba, Farhana Sharmin, s01-007, s02-039
 Dibden, James, s06-116
 Dieleman, Christian, (Fri 13)09:50
 Díez, Ismael, s16-044
 Díez, José Antonio, (Tue s14)18:00
 Díez-Buitrago, Beatriz, (Tue s03)18:20
 Díez-Pérez, Ismael, (Mon s15)18:20, (Wed

- s03)09:50
 Dilger, Stefan, (Thu 20)17:40, s10-058
 Dillet, Jérôme, (Thu 07)15:00
 Dimé, Abdou, s15-010
 Dimitrova, Anna, s06-027, s06-047
 Dinçer, Hatice, s10-078
 Ding, Bo, (Fri 06)09:50
 Ding, Markus, s06-080, s06-112
 Ding, Xiao-Bing, (Mon s16)10:10
 Dinh, Hung Cuong, (Mon s16)18:20
 Dionigi, Fabio, (Mon s07)09:30,
 (Tue s07)16:40
 Dixon, Ditty, (Thu 07)15:20, s07-039
 Dlugolecki, Piotr, (Tue s09)15:20
 Dmello, Rylan, s07-042
 do Vale-Júnior, Edilson, s11-022
 Doai, Hanh, (Tue s15)09:30
 Dobrovolskiy, Yuriy, s06-015
 Doeff, Marca, (Tue s06)17:00
 Döring, Harry, (Thu 12)15:20
 Doeven, Egan, s20-052
 Doherty, Andrew, (Mon s15)16:40
 Dolgikh, Olga, (Tue s13)15:20, s20-061
 Dolhem, Franck, (Thu 06)15:40
 Dolinska, Joanna, s02-047, s03-038
 Doll, Theo, s04-016
 Doménech-Carbó, Antonio, s20-008,
 s20-009
 Doménech-Carbó, María Teresa, s20-008,
 s20-009
 Domian, Elisabeth, s07-045
 Dominguez-Benetton, Xochitl, (Wed
 s05)11:10, s10-083, s15-011
 Domínguez-Crespo, Miguel A., s07-128,
 s10-075, s13-002, s13-012
 Dominko, Robert, (Mon s06)17:00,
 (Tue s06)15:20
 Domke, Katrin F., (Tue s16)17:20, (Wed
 s16)10:30, s15-032
 Domnik, Lilith, (Thu 18)14:40
 Doneux, Thomas, (Mon s16)16:00,
 s14-012, s16-030, s18-014
 Dong, Chang-Zhi, (Thu 10)17:40
 Dong, Chunlin, s20-038
 Dong, Xiaoli, s07-046
 Dong, Zhi Gang, (Fri 13)10:10
 Dongjun, Wu, (Fri 10)10:10
 Dongmo, Saustin, (Tue s01)15:20,
 (Thu 20)16:00, s04-026
 Donkeng Dazie, Joel, s15-033
 Donner, Constanze, s11-045
 Donoso, José, s13-022
 Doo, Seok-Gwang, (Tue s06)10:30
 dos Santos, Alexandro Jhones, s11-021
 Dos Santos, Luis P. M., s14-007
 dos Santos Sardinha, Eduardo, s06-080,
 s06-081
 Dosche, Carsten, s04-026
 Dosta, Sergi, s11-022
 Dou, Xinwei, (Mon s06)15:20, s06-097
 Douard, Camille, (Tue s08)14:20
 Downard, Alison, (Thu 10)18:20
 Doyle, Richard, s10-002
 Drakselová, Monika, s07-067
 Drautz, Ralf, s07-089
 Drazic, Goran, (Fri 07)11:30
 Dresp, Soeren, (Tue s07)16:40
 Drewett, Nicholas, s06-001, s06-079
 Dreyer, Wolfgang, s09-021, s17-010
 Drncic, Jakub, (Mon s07)09:30,
 (Tue s07)17:40, (Fri 07)10:10,
 s07-059, s16-010
 Drob, Silviu Iulian, s13-013
 Drozhzhin, Oleg, s06-013, s06-065,
 s06-106
 Dryfe, Robert, (Fri 10)11:10
 Dsoke, Sonia, (Mon s08)18:00
 Du, Cuiwei, s13-019
 Du, Rong-Gui, s13-025
 Du, Yianfeng, s06-020
 Duan, Jizhou, s13-018
 Duarte, Raquel, s08-025
 Dubau, Laetitia, (Tue s07)09:50,
 (Tue s07)17:40, (Fri 07)10:10, s07-099
 Dubois, Marc, (Tue s07)09:50
 Dumaz, Philippe, (Mon s06)18:20
 Dundalek, Jan, s07-037, s07-038, s07-041
 Durante, Christian, (Thu 07)18:20,
 s07-074, s07-110
 Durikova, Helena, (Thu 04)15:20
 Durmus, Yasin Emre, (Mon s06)15:00,
 (Mon s06)15:00
 Dursun, Burcu, s06-098, s06-099
 Durupthy, Olivier, s07-139
 Dutta, Monica, (Thu 07)15:00, s12-004
 Dyballa, Katrin M., s11-052
 Dyck, Alexander, (Thu 07)10:10
 Dyjak, Slawomir, (Tue s08)16:40
 Dykstra, Jouke, (Tue s09)16:00, s09-006
 Dzade, Nelson Y., s18-037
 Dzubiella, Joachim, s06-127
- E**
 Eascott, Jennie, s07-124
 Eck, Ernst, s06-139
 Eckert, Kerstin, s07-018
 Edström, Kristina, (Mon s06)10:10,
 (Mon s06)14:40, (Wed s06)09:30,
 (Thu 16)09:50, s06-006, s06-014,
 s06-072
 Efimov, Igor, s16-024
 Egashira, Minato, s06-113
 Eguchi, Taku, (Thu 07)14:40
 Eguilaz, Marco, s02-001
 Eguiluz, Katlin, (Tue s11)15:00, s02-019,
 s09-015, s09-016
 Ehrenberg, Helmut, (Thu 07)15:20,
 s06-062, s07-039
 Eichel, Ruediger-A., (Mon s16)14:20,
 (Mon s06)15:00, (Thu 06)09:30,
 s06-019, s06-109, s10-023
 Eickhoff, Martin, (Tue s03)18:00
 Eienne, Mathieu, s11-056
 Eikerling, Michael, (Wed s16)09:30
 Ein Eli, Shaked, s09-002
 Eisenberg, David, (Thu 07)09:30
 Eisi Toma, Henrique, s02-004
 Ekinci, Yasin, (Fri 07)11:50
 El-Nouby, Mohamed, s07-106
 Elbersen, Rick, s18-039
 Elbert, Johannes, (Wed s09)09:30
 Elia, Giuseppe Antonio, s06-069
 Elsner, Cecilia I., s13-006
 Elton, Darrell, (Mon s01)09:30
 Elumalai, Ganesan, (Mon s16)18:20
 Elzanowska, Hanna, s03-057, s04-017
 Emanuelsson, Rikard, (Thu 10)17:20,
 s10-026, s10-038
 Emets, Victor, s07-068, s16-019
 Emir, Güray, s11-018
- Enache, Mirela, s20-015
 Enache, Teodor Adrian, s04-018
 Enachescu, Marius, s14-002
 Enciso, Paula, s20-018
 Endres, Frank, s06-037
 Endrödi, Balázs, (Fri 10)11:10
 Eng, Alex, s02-050
 Engel, Mareike, s05-002
 Engelbrekt, Christian, s18-035
 Engstfeld, Albert, (Tue s16)14:00
 Enoksson, Peter, s06-035
 Ensafi, Aliasghar, s02-065, s10-059
 Enzinger, Norbert, s07-123
 Erbe, Andreas, s07-021, s17-001
 Erden, Pinar Esra, s10-089, s10-091
 Eren, Hamit, s06-092
 Erikson, Heiki, s16-006
 Erini, Nina, (Thu 07)16:00
 Erné, Ben, s09-020, s16-020
 Errachid, Abdelhamid, s01-038
 Ersen, Ovidiu, (Tue s07)17:40
 Ertekin, Zeliha, s09-022
 Escalera López, Daniel, s10-003
 Escribano, P.G., s07-102
 Escribano, Sylvie, (Mon s07)14:00
 Escudero-Escribano, Maria,
 (Mon s16)15:00, (Tue s07)17:20,
 s16-012
 Escudero-Rincón, María L., s13-002
 Esparza, Diego, s12-009
 Espinoza, Carolina, s11-057
 Esposito, Giovanni, (Tue s11)16:40
 Eßmann, Vera, (Mon s01)16:00,
 (Tue s03)10:10
 Estrada-Vargas, Arturo, s03-056
 Eswaramoorthy, Muthusamy, s10-071
 Etienne, Mathieu, (Mon s03)16:40
 Etman, Ahmed S., s06-014
 Eurich, Svitlana, s06-019, s10-023
 Euvrard, Myriam, (Tue s14)17:20
 Evers, Mathies, s02-024
 Evschik, Elizaveta, s06-015
 Eychmüller, Alexander, (Tue s07)18:00
- F**
 Fàbrega, Cristian, (Fri 18)09:30
 Fabregat-Santiago, Fran, (Wed s05)10:10
 Fajardo, Ana S., s11-019, s11-020
 Fajardo, Oscar, (Mon s17)10:10
 Falaras, Polycarpus, s02-034
 Fan, Gaochao, s03-061, s03-064
 Fan, Louzhen, s18-029
 Fan, Miao-Syuan, s12-001, s12-005
 Fang, Qinghong, (Mon s13)15:40
 Fanjul Bolado, Pablo, s03-043
 Fantin, Armando, s15-007
 Fantin, Marco, (Mon s15)17:40, s15-007,
 s15-008
 Fapyane, Deby, s03-044
 Farinos, Rosimeire, s11-036
 Farka, Zdeněk, s02-025
 Farkhondehfar, M. Amin, s18-004
 Fatibello-Filho, Orlando, s01-025,
 s02-019, s02-020, s02-026, s02-027
 Fattah, Zahra, (Thu 10)10:10
 Fauth, François, (Thu 06)17:00
 Favier, Frédéric, (Tue s08)14:20
 Fedorov, Maxim V., (Tue s08)17:20,
 s06-026
 Feier, Bogdan, s03-053

- Feifel, Sven C., (*Thu 18*)15:20
 Feldman, Yishai, (*Fri 10*)11:10
 Felici, Roberto, *s16-010*
 Feliu Martinez, Juan Miguel,
 (*Mon s16*)14:00, (*Mon s16*)18:00,
s01-020, s16-002, s16-006
 Fellingner, Tim-Patrick, *s10-015*
 Fellows, Tamika, *s04-007*
 Femmer, Robert, *s09-007*
 Feng, F., (*Mon s01*)15:00
 Feng, Liang, *s06-045*
 Feng, Tianyu, *s06-020*
 Fenga, Paula G., *s03-018*
 Fenk, Bernhard, (*Mon s06*)17:20
 Fenske, Daniela, (*Tue s01*)15:20
 Ferapontova, Elena E., (*Mon s03*)18:00,
 (*Thu 04*)15:40, *s03-040, s03-044*
 Ferhat, Mahmoud, *s11-047*
 Fermin, David J., (*Mon s07*)17:20
 Fernandes, Caio, (*Wed s13*)10:10
 Fernandez Macia, Lucia, (*Mon s01*)10:10,
s04-015, s06-078, s07-069
 Fernandez Marchante, Carmen María,
s05-003, s05-004
 Fernandez, Pablo Sebastian, *s16-007,*
s16-008, s20-046
 Fernández-Domene, Ramón M., *s10-060,*
s10-061, s10-066, s10-067, s10-073
 Fernández-Pérez, Bibiana, (*Tue s13*)18:20
 Feroci, Marta, *s15-002, s15-003*
 Ferragud, Xavier, *s20-008*
 Ferrari, Begoña, (*Tue s14*)18:20, *s14-016*
 Ferrari, Gabriele, (*Mon s13*)10:10
 Ferrari, Giorgio, (*Thu 02*)16:40
 Ferreira da Costa, Tamires, *s16-037,*
s16-052
 Ferreira de Araujo, Jorge, (*Mon s07*)10:10,
 (*Tue s07*)16:40
 Ferreira, Fabricia R., (*Tue s15*)10:30
 Ferreira, Graziela C.A., *s16-021*
 Ferreira, Hendrik, *s20-044*
 Ferreira, Marystela, *s02-059*
 Ferreira, Virginia, (*Tue s16*)16:00
 Ferro, Leticia M.M., *s02-059*
 Fetyan, Abdul Monem, (*Wed s07*)09:30
 Feynerol, Vincent, (*Mon s11*)15:20
 Fic, Krzysztof, (*Tue s08*)10:30,
 (*Tue s08*)14:40, (*Tue s08*)15:00,
 (*Tue s08*)15:00, *s08-001, s08-009,*
s08-020
 Fichtner, Maximilian, *s06-007, s06-008*
 Figueiredo, Marta, *s16-004, s16-009,*
s16-013, s18-023
 Figueredo-Rodríguez, Horacio Antonio,
s06-085
 Figueroa, Pablo, *s13-022*
 Filhol, Jean-Sébastien, (*Mon s17*)14:40
 Filiâtre, Claudine, (*Tue s14*)17:20, *s14-016*
 Fino, Debora, *s11-029*
 Firet, Nienke, *s18-009*
 Fischer, Anna, *s03-045, s03-049*
 Fischer, Arthur, *s11-046*
 Fischer, Elena, (*Tue s16*)14:00
 Fitch, Samuel, (*Fri 06*)09:30
 Flis, Janusz, *s07-007, s07-008*
 Flis-Kabulska, Iwona, *s07-007, s07-008*
 Floner, Didier, (*Fri 07*)11:30
 Florea, Anca, *s02-049, s04-001, s04-005*
 Flores, Eibar, *s16-022*
 Florez-Rodriguez, Pedro, *s01-048*
 Flox, Cristina, (*Fri 07*)11:50, *s11-039*
 Fogel, Ronen, *s03-054, s04-007*
 Fojta, Miroslav, (*Mon s03*)17:20
 Folkertsma-Hendriks, Laura, *s02-056*
 Fontana, Daniela, *s06-058*
 Fontana, Marco, (*Mon s08*)16:00
 Ford, Michael J., (*Mon s03*)09:30
 Foret, Frantisek, *s02-025*
 Fornasiero, Paolo, (*Fri 10*)10:10, *s10-022*
 Forner-Cuenca, Antoni, (*Mon s07*)14:20
 Fornés, Juan Pablo, *s11-049*
 Forrest, Gregory, (*Thu 20*)14:20
 Forsyth, Maria, (*Tue s06*)09:30, *s06-083*
 Fortgang, P., (*Mon s01*)15:00
 Foster, Christopher W, *s01-019*
 Foster, Erick, (*Wed s02*)10:10
 Fourmond, Vincent, (*Mon s03*)10:10,
 (*Tue s03*)14:40, (*Thu 18*)14:40
 Fracasso, Giulio, *s15-037*
 Fraccari, Raquel, (*Thu 02*)16:40
 Frackowiak, Elzbieta, (*Tue s08*)10:30,
 (*Tue s08*)15:00, *s08-020*
 Francis, Paul, *s01-005, s20-052*
 Franco, Alejandro A., (*Tue s06*)16:40,
s06-042
 Frank, Uta, (*Mon s15*)15:20
 Franke, Robert, *s11-052*
 Fransaer, Jan, (*Tue s14*)14:00
 Fransen, Martijn, (*Tue s01*)15:00
 Frantz, Cédric, (*Tue s14*)17:40, *s14-008*
 Frausto, Roberto, *s11-014*
 Freakley, Simon, (*Thu 07*)18:00
 Freedman, Kathrin, (*Mon s06*)16:40
 Freguia, Stefano, *s05-008*
 Freiberg, Anna, (*Thu 07*)14:20
 Fréty, Nicole, *s11-045*
 Freunberger, Stefan A., (*Thu 06*)17:20,
 (*Fri 06*)10:10
 Friedl, Jochen, (*Wed s07*)09:50
 Friedrich, K. Andreas, (*Mon s07*)14:40,
 (*Mon s07*)18:20, (*Wed s16*)09:50,
s06-114
 Frik, Małgorzata, *s15-021*
 Frisch, Gero, (*Thu 20*)14:20
 Fritea, Luminita, *s04-005, s10-088*
 Frith, Kelly-Anne, *s04-007*
 Fritsch, Benjamin, (*Thu 12*)15:20
 Fröhlich, Jochen, *s07-018*
 Frontana, Carlos, *s05-010, s15-034*
 Frutos Beltrán, Estrella, *s03-041*
 Frokiær, Heidi, *s07-070*
 Fu, Chaopeng, *s06-115*
 Fu, W.T., (*Mon s07*)17:40
 Fuchs, David, (*Thu 16*)09:30
 Fühl, Matthias, (*Wed s07*)10:10
 Fuentes, Angel, *s20-009*
 Fuentes, Rosalba, (*Mon s11*)15:40
 Fuentes-Ramírez, Rosalba, *s12-009*
 Fürbeth, Wolfram, (*Tue s13*)17:00,
 (*Fri 13*)09:30
 Fuhrmann, Jürgen, *s09-018, s20-007*
 Fujii, Kenta, (*Mon s06*)18:00
 Fujimoto, Shinji, (*Tue s13*)14:00
 Fujishima, Akira, *s03-063*
 Fujishiro, Yoshinobu, *s07-145*
 Fukuda, Katsutoshi, (*Fri 06*)11:50
 Fukuda, Seisuke, *s06-066*
 Fukuhara, Tomoko, *s06-090*
 Fukunaga, Hiroshi, *s07-071*
 Fukunaka, Yasuhiro, *s07-009*
 Fung, Kuan-Zong, *s07-095, s07-096*
 Furukawa, Hiroto, *s07-072*
 Furukawa, Kazuaki, *s04-009*
 Fuse, Moritsugu, *s13-015*
- ## G
- Gaberscek, Miran, (*Tue s06*)15:20,
 (*Fri 07*)11:30, *s07-082, s10-015*
 Gabrielli, Serena, *s06-048*
 Gadgil, Bhushan, *s10-084*
 Gärtner, Tobias, *s18-026*
 Gago, Aldo S., (*Mon s07*)18:20, (*Wed*
s16)09:50
 Gajek, Arkadiusz, *s07-008*
 Gala, Fabrizio, *s15-002*
 Galarce, Carlos, *s13-022*
 Galia, Alessandro, (*Mon s11*)17:00,
s11-040
 Galiano, Hervé, *s08-004*
 Gallego, Luis J., *s06-026*
 Gallo, Irã B.C., *s07-073, s07-132*
 Gallou, Fabrice, *s11-050*
 Galmiche, Laurent, *s10-088*
 Galvão, Tomás, R., *s11-050*
 Gamarra, Jorge D., *s20-060*
 Gamero Quijano, Alonso, (*Tue s01*)09:50
 Ganapathy, Swapna, *s06-016, s06-139*
 Ganassin, Alberto, *s20-019*
 Ganci, Fabrizio, *s07-010, s07-011*
 Ganesan, Vinoth, *s07-026, s08-013*
 Ganiyu, Soliu O., *s09-012*
 Ganzarolli de Oliveira, Marcelo, *s04-029*
 Ganzenko, Aleksandra, (*Tue s11*)16:40
 Gao, Lu, *s07-012, s18-037*
 Gao, Qiang, *s06-030*
 Gao, Wenyue, *s04-012*
 Gao, Xiangwen, (*Fri 06*)10:10
 Gao, Xin, (*Tue s09*)17:20
 Gao, Ying-Bo, *s13-025*
 Gao, Zhida, *s03-062*
 Garbarino, Sébastien, (*Thu 18*)18:20,
s18-019
 Garbayo, Iñigo, (*Mon s06*)10:30
 García - Quismondo, Enrique,
 (*Fri 07*)10:50
 Garcia, Amanda Cristina, (*Mon s16*)15:40
 García, Gonzalo, *s07-113, s07-114*
 Garcia Lastra, Juan Maria, (*Mon s17*)18:20
 Garcia, Luane, *s01-053, s09-010*
 Garcia, Santiago, (*Fri 13*)09:50
 García, Verónica, *s07-125*
 García-Antón, José, *s10-060, s10-061,*
s10-066, s10-067, s10-073, s10-074
 Garcia-Araez, Nuria, *s06-116*
 García-Gabaldón, Montserrat, *s11-004,*
s11-034
 Garcia-Garcia, Dionisio, *s10-074*
 García-Mendoza, Arturo, *s20-004,*
s20-013, s20-014
 García-Montalvo, Verónica, *s07-131*
 Garcia-Segura, Sergi, *s11-021, s11-022*
 García-Zaleta, David S., *s10-075*
 Gardeniers, Han, *s18-039*
 Garoz-Ruiz, Jesús, (*Mon s15*)14:40,
 (*Tue s01*)15:40, (*Tue s01*)16:00
 Garrecht, Harald, *s20-034*
 Gascon, Jorge, (*Mon s07*)17:40
 Gasparetto, Nicolò, (*Tue s01*)10:10

- Gatalo, Matija, (*Fri 07*)11:30
 Gateshki, Milen, (*Tue s01*)15:00
 Gaubeur, Ivanize, *s01-039*
 Gaubicher, Joel, (*Thu 06*)15:40
 Gaumont, Thomas, (*Thu 07*)15:00
 Gauquelin, Charles, (*Mon s03*)10:10
 Gaus, Katharina, *s04-002*
 Gavilán, Maximiliano, *s06-042*
 Gavutis, Martynas, *s10-080*
 Gavvalapalli, Nagarjuna, *s07-042*
 Gawlak, Karolina, (*Fri 10*)09:50, *s10-051*
 Gayle, Marvin, *s10-093*
 Gazdzicki, Pawel, (*Mon s07*)18:20
 Geboes, Bart, (*Thu 10*)14:00, *s18-025*
 Geels, Norbert J., (*Thu 07*)09:30
 Geier, Sebastian, (*Mon s08*)17:20
 Geiger, Simon, (*Tue s07*)09:30,
 (*Thu 07*)16:40, (*Thu 07*)18:00, *s07-111*,
s07-113, *s10-004*
 Geirnaert, Annelies, (*Wed s05*)10:30
 Geist, Lena, *s03-006*
 Gelneberg, Jens, (*Fri 06*)11:10
 Genç, Aziz, *s07-003*
 Gendel, Youri, (*Tue s09*)15:00
 Geneste, Florence, (*Fri 07*)11:30
 Gennaro, Armando, (*Mon s15*)17:40,
 (*Thu 07*)18:20, *s01-001*, *s07-074*,
s07-110, *s15-004*, *s15-008*, *s15-009*
 Genorio, Bostjan, (*Tue s06*)15:20
 Gensicke, Ronald, (*Fri 13*)11:50
 Gerardin, Karine, (*Thu 12*)16:00
 Gerasimova, Irina, *s07-057*
 Geronimo, Hannah Grace, *s20-029*
 Gervasi, Claudio A., *s02-022*
 Gesset, Céline, (*Thu 20*)15:20
 Gewirth, Andrew, (*Mon s16*)16:40
 Ghalkhani, Masoumeh, *s02-028*, *s02-029*
 Ghedini, Paulo Cesar, *s01-021*, *s01-053*,
s04-027, *s04-028*, *s20-053*
 Ghiulnare Apaz, Aida, *s14-003*
 Gichan, Olga, *s17-007*
 Gielis, Sven, *s06-082*
 Gigot, Arnaud, (*Mon s08*)16:00
 Gil, Eric, *s01-021*, *s01-053*, *s04-027*,
s04-028, *s09-010*, *s20-053*
 Gilek, Dominika, *s10-051*
 Gillion, Julie, (*Thu 10*)10:10
 Giordano, Livia, (*Thu 07*)17:20
 Girado, Sergio, (*Fri 18*)10:10
 Girardi, Marcelo, *s18-002*
 Girault, Hubert, (*Thu 20*)09:30,
 (*Thu 20*)16:00, (*Fri 07*)09:30, *s07-032*,
s07-092, *s15-035*, *s17-003*
 Girstun, Agnieszka, *s03-057*, *s04-017*
 Glenneberg, Jens, (*Thu 06*)14:20
 Gliech, Manuel, (*Mon s07*)10:10
 Gloaguen, Frederic, (*Tue s15*)10:10
 Gluyas, Josef, (*Thu 16*)10:10
 Gnidina, Inna, *s20-039*, *s20-041*
 Go, Hyungho, *s06-111*
 Goddard, Alex, (*Thu 20*)14:20
 Godfrey, Daniel, *s11-048*
 Godoi, Keyla, *s07-075*
 Göbel, Gero, *s03-024*
 Gödrich, Sebastian, (*Tue s01*)18:20
 Göttle, Adrien, *s17-008*
 Gogoll, Adolf, (*Thu 10*)17:20, *s10-026*,
s10-030, *s10-038*, *s10-041*
 Goikolea, Eider, (*Mon s08*)17:40
 Goldshtein, Keren, (*Mon s06*)16:40
 Golinelli, Diego, *s02-042*
 Gollas, Bernhard, (*Thu 16*)09:30,
 (*Thu 06*)17:20, *s07-048*
 Golodnitsky, Diana, (*Mon s06*)16:40,
 (*Tue s06*)14:00, *s06-003*
 Gomes, Adriano, (*Mon s11*)10:30
 Gomes, Janaina Fernandes, (*Tue s16*)09:50
 Gomes-Marin, Ana M., (*Thu 07*)17:40
 Gómez, Elvira, *s02-031*, *s07-118*, *s07-119*,
s10-046
 Gomez, Humberto, *s10-045*
 Gómez-Gil, José María, (*Thu 20*)10:10
 Gonçalves de Aquino Saglietti, Guilherme,
s07-127
 Gonçalves, Roger, (*Thu 20*)18:00, *s02-041*
 Gond, Ritambhara, (*Wed s06*)09:50
 Gong, Coucong, *s02-014*
 Gong, Jianying, *s14-009*
 Gong, Shuishui, *s08-043*
 Gong, Yi, *s06-115*
 Goñi-Urtiaga, Asier, *s03-003*
 Gonzaga de Melo, Iasmim, *s02-019*
 Gonzalez, Carolina, *s01-041*
 Gonzalez, Ernesto, (*Fri 07*)11:10
 González García, María Begoña, *s03-043*
 González, Ignacio, *s11-014*, *s15-028*
 González Pérez, Omar, *s11-001*
 Gonzalez, Zoilo, (*Tue s14*)18:20, *s14-016*
 Gonzalez-Arribas, Elena, *s03-017*
 González-Dieguez, Noelia, (*Tue s01*)16:00
 Gonzalez-Gutierrez, Linda, *s05-010*
 González-Vargas, Camilo, *s01-043*
 Gooding, J. Justin, *s04-002*
 Goor, Meital, (*Mon s06*)16:40,
 (*Tue s06*)14:00, *s06-003*
 Gorbachuk, Elena, *s11-023*
 Gorbатовski, Georg, *s16-026*
 Gorczyński, Adam, *s15-024*
 Gordo, Elena, (*Tue s14*)18:20
 Gordon, Jonathan, *s05-001*
 Gordon, Zachary, *s06-132*
 Gorgy, Karine, *s10-088*
 Gorlin, Mikaela, (*Tue s07*)16:40
 Gorostiza, Pau, (*Wed s03*)09:50, *s16-044*
 Gorska, Barbara, (*Tue s08*)15:00
 Gorton, Lo, (*Wed s03*)10:40,
 (*Thu 18*)15:40, *s02-054*, *s03-008*
 Goryachev, Andrey, *s16-010*
 Gossage, Zachary, (*Thu 10*)15:40
 Goubard-Bretesché, Nicolas,
 (*Mon s08*)15:40, (*Tue s08*)14:20
 Goudeau, Bertrand, (*Mon s16*)16:00
 Goulart, Lorena, *s02-041*
 Goulart, Marilia, (*Tue s15*)10:30
 Goulet, Marc-Antoni, (*Thu 12*)17:00
 Goyal, Priyamvada, (*Mon s17*)10:30
 Graetzel, Michael, (*Thu 20*)17:40,
 (*Fri 18*)11:10, *s20-018*
 Graham, Louise, (*Mon s15*)16:40
 Granados Mendoza, P., (*Mon s11*)09:50
 Grandi, Maximilian, (*Thu 12*)17:20
 Granozzi, Gaetano, (*Mon s07*)17:20,
s07-110
 Granwehr, Josef, (*Mon s06*)15:00
 Greco, Silvia, *s04-020*
 Gregoratti, Luca, *s16-043*
 Grey, Clare, *s06-125*
 Grez, Paula, *s18-030*, *s18-034*
 Gribkova, Oxana, (*Thu 10*)16:00, *s10-033*
 Griffith, Kent, *s06-125*
 Grimm, Fabian, (*Tue s07*)15:20
 Grimmer, Christoph, (*Thu 12*)17:20,
s07-084
 Grinberg, Vitali, *s07-068*, *s15-005*
 Grippo, Valentina, *s03-019*
 Griveau, Sophie, *s04-029*, *s18-002*
 Groenen Serrano, Karine, (*Tue s11*)14:40,
s11-024
 Groeninger, Patricia, (*Mon s07*)14:20
 Grootjes, Sander, (*Thu 12*)17:40
 Gross, Manuela, (*Tue s03*)09:30
 Grote, Jan-Philipp, (*Tue s07*)09:30,
 (*Fri 07*)11:30, *s07-082*, *s07-111*
 Gruet, Nathalie, (*Tue s13*)14:40
 Grumelli, Doris, *s07-076*
 Grumm, Bettina, (*Fri 06*)10:10
 Gruter, Gert-Jan, (*Thu 18*)14:00
 Grønberg, Ulrik, (*Mon s16*)15:00
 Gu, Wentian, (*Mon s06*)16:00
 Guan, Zi-Chao, *s13-025*
 Guang, Shanyi, *s08-043*
 Guanyue, Gao, *s01-023*
 Guay, Daniel, (*Thu 18*)18:20, *s18-019*
 Guéguen, Aurélie, (*Tue s06*)18:00
 Günay, M. Emin, *s20-016*
 Guérin, Katia, (*Tue s07*)09:50
 Guerlou-Demourgues, Liliane, *s08-025*
 Guerola Blay, Vincent, *s20-008*
 Guerra-Balcázar, M., *s07-054*, *s07-101*
 Guerriero, Paolo, (*Thu 10*)17:20,
 (*Thu 10*)17:40
 Guétaz, Laure, (*Mon s07*)14:00,
 (*Thu 07*)15:00
 Gütz, Christoph, *s11-050*
 Guhlke, Clemens, *s09-021*, *s17-010*
 Gui, Yang, *s09-003*
 Guilemany, Josep Maria, *s11-022*
 Guille-Collignon, Manon, (*Thu 04*)17:40,
s01-013, *s04-030*
 Guillen, Carlos, (*Tue s01*)16:00
 Guillén-Villafuerte, Olmedo, *s07-114*
 Guillon, François Xavier, *s03-051*
 Guin, Saurav K., *s02-003*
 Gul, Turan, *s15-006*
 Gunby, Nathaniel, (*Thu 10*)18:20
 Guo, Erjun, *s08-044*
 Guo, Renqing, *s06-023*, *s18-038*
 Gurrola, M. P., *s07-101*
 Gustafsson, Torbjörn, (*Tue s06*)10:10,
s06-014, *s06-072*
 Guterman, Vladimir, *s07-056*, *s07-057*
 Gutiérrez, Lucia, (*Thu 04*)15:00
 Gutiérrez Pineda, Eduar, *s02-022*
 Gutierrez Sanchez, Cristina, *s03-042*
 Gutierrez-Granados, Silvia, *s07-036*,
s09-014
 Gutierrez-Sanz, Oscar, (*Mon s03*)10:30
 Gutkowski, Ramona, (*Fri 20*)09:30,
s02-030
 Gutsche, Christian, *s07-142*
 Gutzler, Rico, *s07-076*
 Guyes, Eric, *s09-004*
 Guyomard, Dominique, (*Thu 06*)15:40
 Guyot, Elodie, *s11-002*
 Guzman, Diego, *s18-011*
 Guzmán-Hernández, Dafne, *s01-022*
 Guzman-Ocampo, Dulce Consuelo,

- s20-013, s20-014
Gwinner, Benoît, (*Tue s13*)14:40
- H**
- Ha, Sang-hyeon, s20-020, s20-024, s20-025
Ha, Sanghyun, s20-022
Habibi, Mohammad Mahdi, s02-058
Habrioux, Aurélien, s07-139
Hacker, Viktor, (*Mon s07*)15:00, (*Thu 12*)17:20, s06-038, s07-040, s07-084
Hadermann, Joke, s06-013
Hadj-Saïd, Jessica, (*Thu 18*)14:40
Haensch, Mareike, s16-011
Haesong, Jeon, s06-120
Haga, Masa-aki, (*Fri 10*)11:30, s02-043, s15-023
Hagberg, Johan, s06-017
Hagfeldt, Anders, (*Thu 10*)17:40
Haghighatbin, Mohammadamin, s18-031
Hahlin, Maria, (*Thu 16*)09:50
Hahn, Robert, s10-068, s20-026, s20-027
Hainque, Bernard, s03-051
Haiss, Wolfgang, (*Thu 16*)10:10
Hajdari, Zana, (*Mon s13*)15:20, s13-020
Hájková, Andrea, s03-055
Hakamata, Hideki, s01-006
Halder, Arnab, (*Mon s03*)09:30, (*Wed s02*)09:50, (*Fri 10*)11:50, s10-090
Halim, Martin, s08-008
Hall, Peter, (*Mon s08*)16:40, s08-005
Halouzka, Vladimir, s01-049, s02-034
Halouzskova, Barbora, s02-034
Hamadou, Lamia, s10-042
Hamaguchi, Maki, s06-141
Hamazaki, Makoto, s07-081
Hamed, Emad M., (*Tue s15*)09:30
Hamelers, Bert, (*Tue s09*)14:00, s17-011
Hammer, Peter, s20-050
Hamnca, Siyabulela, (*Thu 02*)15:40
Han, Bo, s06-030, s06-045
Han, Byungchan, s07-077
Han, Chao, s18-032
Han, Donghoon, (*Wed s02*)10:10
Han, Gaoyi, s14-001
Han, Hye Youn, s01-007
Han, Jae Hee, s08-034
Han, Sang-Beom, s10-062, s10-064, s10-065
Handl, Michael, (*Mon s07*)14:40
Hanif, Saima, s04-012
Hannach, Mohamed, s12-004
Hansen, Heine, (*Mon s17*)15:40
Hansen, Martin H., (*Mon s16*)15:00
Hanß, Daniel, (*Mon s16*)14:20
Hao, Shimeng, (*Thu 06*)15:00
Happe, Thomas, (*Tue s03*)14:40, s03-005
Haque, Al-Monsur Jiaul, s01-004
Hara, Agnieszka, (*Mon s13*)14:00
Hara, Masanori, (*Thu 07*)14:40
Harada, Masashi, (*Wed s16*)10:10
Harbouai, Doha, (*Mon s06*)18:20
Hardacre, Christopher, (*Thu 07*)15:40, s07-105, s07-112
Hardwick, Laurence, s06-001
Hardy, An, s06-082
Harima, Yutaka, s10-028
Harish, Srinivasan, s10-071
Harrington, David, (*Thu 18*)18:00
Harris, Robert, s11-051, s14-004
Harroun, Scott, (*Tue s01*)17:40
Hartl, Frantisek, (*Thu 16*)10:10
Hartley, Jennifer, (*Thu 20*)14:20
Hartmann, Jens, (*Tue s11*)17:20
Hartmann, Mark, s07-044
Hartmann, Markus A., (*Tue s08*)15:40
Hartmann, Tobias, s03-048
Hartmann, Volker, (*Tue s03*)10:10
Hasa, Bjorn, s11-025
Hasan, Kamrul, (*Wed s03*)10:40, (*Thu 18*)15:40
Hasegawa, Shohei, (*Tue s13*)14:00
Hasegawa, Takahiro, s06-090
Hasegawa, Takuya, (*Thu 12*)14:40
Hashimoto, Kazuhito, (*Thu 18*)17:20
Hassel, Achim Walter, (*Tue s13*)14:20, s04-016
Hassenknopf, Bernold, (*Thu 10*)15:00
Hatton, T. Alan, (*Wed s09*)09:30, s09-011, s09-019
Hatzell, Kelsey B., (*Thu 07*)14:00
Hauffman, Tom, s20-060
Hausoul, Peter, s07-006
Haverkamp, Jan-Steffen, (*Tue s07*)18:20
Hazama, Taisuke, (*Mon s06*)18:00
He, Daping, s02-011, s02-032, s02-077
He, Dong Sheng, s02-032
He, Juan, s03-011
He, Minglong, (*Tue s08*)10:30, (*Tue s06*)18:00
He, Ping, s06-117
He, Ronghuan, s10-076
He, Xiang, s01-035
He, Zhengda, s17-005
Hebié, Seydou, s15-010
Hebrant, Marc, s01-033
Hecken, Nadine, s11-050
Hecker, Burkhard, (*Tue s07*)18:20, s10-005
Heckmann, Andreas, s06-118
Hector, Andrew, (*Thu 06*)18:00, (*Fri 06*)09:30, (*Fri 20*)11:30, s08-042
Hedenstedt, Kristoffer, (*Tue s16*)15:20
Hederstedt, Lars, (*Wed s03*)10:40
Heenen, Hendrik H., s17-009
Hegemann, Martina, s06-108
Hegemann, Philip, s06-108
Heim, M., (*Wed s03*)10:10
Heintz, Olivier, s10-037, s15-010
Heise, Svenja, s14-017
Hejazi, Mahdi, s03-006
Hejazi, Sina, s07-013, s07-013, s18-033
Helsen, Joost, (*Thu 09*)09:30
Hemmatifar, Ali, (*Tue s09*)09:30
Hempelmann, Rolf, s06-010, s07-030
Hempenius, Mark, s02-056
Henig, Joerg, s03-005
Henning, Sebastian, (*Tue s07*)18:00
Henríquez, Rodrigo, s10-050, s10-087, s10-097, s12-002
Hensen, Emiel J.M., s07-012, s16-010, s18-037
Heo, Jongwook, s06-119
Heo, Kookjin, s06-018
Hepp, Karl, s09-007
Heras, Aranzazu, (*Mon s15*)14:40, (*Tue s01*)15:40, (*Tue s01*)16:00, s02-031, s02-035
Herbst, Frédéric, s10-037, s15-010
Hereijgers, Jonas, (*Thu 18*)17:00, s11-032, s18-025
Heringa, Jouke R., s06-016
Herlitze, Stefan, s04-031
Hermann, Johannes, (*Mon s16*)14:40
Hernández, Anayantzin, s07-078
Hernandez, Angel, (*Fri 07*)10:50
Hernandez Santos, David, s03-019, s03-043
Hernandez Saravia, Lucas Patricio, s02-004
Hernandez, Simelys, s11-029, s18-004
Hernández-Alonso, Maria Dolores, (*Fri 18*)09:30
Hernandez-Burgos, Kenneth, (*Mon s16*)10:30, (*Thu 10*)15:40
Hernández-Pérez, Maria A., s07-128
Herrada, Verónica, (*Tue s11*)17:40
Herranz, Juan, (*Tue s07*)18:00, (*Fri 07*)11:50
Herreman, Wietze, s06-129
Herrera, Santiago, s07-076
Herrero, Enrique, (*Mon s16*)18:00, s16-002
Hersbach, Thomas, (*Fri 13*)11:10
Hervault, Yves-Marie, s15-015
Herzog, Gregoire, (*Tue s01*)09:50, s01-033, s02-033
Hesp, Colin R., (*Tue s15*)09:30
Hesse, Sabine, (*Tue s07*)15:20
Hetemi, Dardan, (*Thu 10*)18:00
Hetterscheldt, Dennis, s15-026
Heubner, Christian, s01-003
Heurtault, Stéphane, (*Tue s13*)09:30
Heyser, Cristopher, s18-030, s18-034
Hiesgen, Renate, (*Mon s07*)14:40
Higgins, Simon, (*Thu 16*)10:10
Hihath, Joshua, (*Mon s03*)14:40
Hilder, Matthias, (*Tue s06*)09:30
Hill, Michael, (*Mon s03*)14:00
Hillman, Robert, (*Tue s08*)16:00, (*Tue s14*)16:00, (*Tue s16*)16:00, (*Thu 10*)14:00, s20-051
Hinds, Gareth, (*Mon s07*)16:40
Hinks, Jamie, s02-007
Hiratsuka, Kaori, s06-113
Hlil, El-Kebir, (*Mon s06*)18:20
Hlongwa, Ntuthuko Wonderboy, s06-025
Hnat, Jaromir, (*Mon s11*)14:00
Ho, Cheng-En, (*Fri 13*)10:50, s11-026, s11-026, s13-003, s14-006, s14-014
Ho, Ja-an Annie, (*Thu 02*)17:40
Ho, Kuo-Chuan, s12-001, s12-005
Ho, Lance, s03-054
Hao, Yongsheng, (*Mon s13*) 15:40
Hoang, Thao, (*Mon s16*)16:40
Hodnik, Nejc, (*Fri 20*)10:10, (*Fri 07*)11:30, s07-082
Hodouchi, Kazunori, s14-011
Höhlinger, Michael, s14-017
Hoetger, Diana, s07-076
Hof, Ferdinand, s15-030
Hoffmann, Anja, s06-019
Hoffmann, Michael R., (*Fri 20*)11:50
Hofmann, Jan P., s07-012, s16-010, s18-037
Hogan, Conor, (*Mon s01*)09:30, s01-005, s18-031, s18-036
Hojo, Daisuke, (*Tue s03*)09:30
Holby, Edward F., (*Tue s07*)14:20

- Holdynski, Marcin, *s02-047, s03-038*
 Holland, Alex, *s06-126*
 Hollingsworth, Nathan, *s16-050*
 Holmberg, Nico, *s17-003*
 Holt, Katherine B., *s16-050*
 Holuscha, David, *(Tue s13)17:00*
 Holze, Rudolf, *s06-020, s08-032*
 Holzinger, Angelika, *(Fri 02)11:30*
 Homem-de-Mello, Paula, *s16-018*
 Homma, Takayuki, *s07-009*
 Hong, Min Young, *s06-021, s06-034*
 Hong, Seung-Tae, *s06-119*
 Hong, Wesley, *(Thu 07)17:20*
 Hong, Yu-Hao, *s15-031*
 Honma, Kazumasa, *s20-057*
 Honores, Jessica, *s18-011*
 Hoogeland, Martijn, *(Mon s13)10:10*
 Hornberger, Helga, *s14-017*
 Horng, Ren-Yang, *s09-023*
 Horstmann, Birger, *s16-053*
 Horswell, Sarah, *(Thu 03)10:10*
 Hoshi, Nagahiro, *(Tue s16)18:00*
 Hoshi, Yoshinao, *(Tue s13)10:10, s03-025*
 Hoshino, Tsuyoshi, *(Mon s11)18:20*
 Hoskocová, Irena, *s15-014*
 Hosseini Nia, Bahram, *s02-017*
 Hosseinpour, Saman, *s13-020*
 Hosu, Oana, *s10-029*
 Hou, Baorong, *(Mon s13)10:30*
 Hou, Chengyi, *(Wed s02)09:50, (Fri 10)11:50, s18-035*
 Hou, Chia-Hung, *(Tue s09)15:40, (Tue s09)18:00, s09-001, s11-006*
 Hou, Yuyang, *s06-086*
 Houmam, Abdelaziz, *(Tue s15)09:30*
 Hovestad, Arjan, *(Thu 10)16:40*
 Howlett, Patrick, *(Tue s06)09:30, s06-083*
 Hrbac, Jan, *s01-049, s02-034*
 Hrstka, Roman, *(Thu 04)15:20*
 Hsieh, Wan-Zhen, *(Fri 13)10:50, (Fri 13)10:50*
 Hsing, I-Ming, *(Mon s01)16:40*
 Hsu, Da-Je, *(Tue s08)14:00*
 Hu, Chi-Chang, *(Tue s08)14:00, s02-047*
 Hu, Jin-Song, *s07-079*
 Hu, Juan, *s13-025*
 Hu, P., *(Thu 07)15:40, s07-093*
 Hu, Shu, *s16-045*
 Hu, Xin-Ming, *s18-010*
 Hu, Yang, *(Tue s07)14:40*
 Hu, Yong-Sheng, *(Wed s06)10:10*
 Huang, Hao, *(Thu 10)17:20, s10-030*
 Huang, Jiaxin, *(Mon s06)16:00*
 Huang, Jun, *(Wed s16)09:30*
 Huang, Ling, *s06-022*
 Huang, Sheng-Chao, *s16-046*
 Huang, Sheng-Siang, *s08-026*
 Huang, Teng-Xiang, *s16-046*
 Huang, Xia, *(Tue s09)10:10*
 Huang, Xiao, *(Thu 10)17:20, s10-041*
 Huang, Xiaohua, *s06-023*
 Huang, Yi-Fan, *s16-009, s16-023, s16-038*
 Huang, Yi-June, *s12-001, s12-005*
 Huang, Zhuangqun, *(Tue s01)18:20*
 Hubin, Annick, *(Mon s01)10:10, (Tue s14)15:00, (Thu 10)14:00, s04-015, s06-078, s07-069, s20-060*
 Hudari, Felipe, *s02-060*
 Hughes, Anthony, *(Fri 13)09:50*
 Huguenot, David, *(Tue s11)16:40*
 Huguet, Patrice, *(Thu 07)14:40*
 Hui, Jingshu, *(Mon s16)10:30*
 Huiliñir, Cesar, *s11-044*
 Hung, Min-Sheng, *s03-039*
 Hunt, Ian, *(Thu 12)15:40*
 Huo, Zhaohui, *(Thu 10)15:00*
 Hursán, Dorottya, *s18-005*
 Hush, Noel S., *(Mon s03)09:30*
 Hushpulan, Dmitry M., *s03-008*
 Huskens, Jurriaan, *s18-039*
 Hussainova, Irina, *s04-023*
 Hussein, Kalso, *(Wed s03)10:00, s03-019*
 Hutchings, Graham J., *(Thu 07)18:00*
 Hwang, Ee Taek, *(Tue s03)09:30*
 Hwang, Eunyoung, *s07-016*
 Hwang, Hojin, *s11-003, s11-005*
 Hwang, Imgon, *s02-066, s10-063*
 Hwang, Inseong, *(Thu 04)10:10*
 Hwang, Jeemin, *s07-077*
- I**
- Iadecola, Antonella, *(Tue s08)14:20*
 Iakobson, Olga, *(Thu 10)16:00, s10-033*
 Ibañez, David, *(Mon s15)14:40, s02-031, s02-035*
 Ibañez-Huerta, Abel, *s11-014*
 Iftekhar, Maryam, *s06-001*
 Ihara, Masahiro, *s07-083*
 Ihrfors, Charlotte, *s06-024*
 Iiyama, Akihiro, *(Thu 07)14:40, (Fri 07)10:50, s07-083, s07-120*
 Ikeda, Daiki, *(Tue s07)16:00*
 Ikeda, Katsuyoshi, *(Tue s16)18:00*
 Ikpo, Chinwe, *s06-025*
 Im, Dongmin, *(Tue s06)10:30*
 Imae, Ichiro, *s10-028*
 Imai, Hideto, *s07-081*
 Inaba, Minoru, *(Fri 07)09:30*
 Inada, Ryoji, *(Tue s06)17:40, s06-059*
 Indris, Sylvio, *s06-062*
 Inesi, Achille, *s15-002*
 Inganäs, Olle, *(Fri 10)09:30*
 Inguanta, Rosalinda, *(Fri 10)10:50, s04-020, s07-010, s07-011*
 Iniesta, Jesus, *s01-019, s01-020*
 Inkpen, Michael, *s15-025*
 Ino, Kosuke, *(Mon s01)14:40, s02-057*
 Inostroza, Elizabeth, *s10-101*
 Inoue, Kumi, *(Mon s01)14:40*
 Inoue, Toshinori, *s06-141*
 Inwood, David, *s02-036*
 Inzelt, György, *(Thu 10)15:20*
 Ionescu, Anca Luiza, *s16-049*
 Ioroi, Tsutomu, *s07-080*
 Iourtchouk, Tatiana, *(Tue s11)17:20*
 Iranzo, Audrey, *(Tue s11)18:20*
 Irtem, Erdem, *(Fri 18)09:30*
 Isaacs, Mauricio, *(Mon s15)17:20, s01-032, s03-036, s18-011*
 Ishige, Yu, *s01-045*
 Ishihara, Akimitsu, *s07-081, s07-126, s07-136*
 Ishihara, Yuki, *(Tue s06)17:40*
 Ishikawa, Hiroaki, *s06-049*
 Ishikawa, Masashi, *(Mon s08)14:20*
 Ishiyama, Tomohiro, *s07-145*
 Islam, Husn-Ubayda, *s16-050*
 Ismail, Abdulghani, *s04-029*
- Isse, Abdirisak A., *(Mon s15)17:40, s15-004, s15-007, s15-008, s15-009*
 Istakova, Olga, *(Thu 10)14:40, s07-034, s10-031, s10-032*
 Itagaki, Masayuki, *(Tue s13)10:10, s03-025, s03-063, s06-066*
 Itagaki, Naho, *s10-070*
 Itagaki, Noriaki, *s07-062*
 Itami, Shunsuke, *(Thu 07)14:40, s07-120*
 Itkis, Daniil, *s16-043*
 Ito, Daiki, *s20-057*
 Ito, Seitaro, *(Thu 06)09:50, (Thu 06)09:50*
 Ivanistsev, Vladislav, *(Tue s08)17:20, s06-026*
 Ivanov, Roman, *s04-023*
 Ivanov, Svetlozar, *s06-027, s06-047, s16-024*
 Ivanov, Viktor, *s10-033*
 Ivanova, Galya, *s08-039*
 Ivošević De Nardis, Nadica, *s03-029*
 Ivusic, Franjo, *s13-026*
 Iwama, Etsuro, *(Tue s08)14:20*
 Iwasaki, Satoshi, *s06-090*
 Iwashita, Risa, *s03-025*
 Iwuoha, Emmanuel, *(Thu 02)10:30, (Thu 02)15:40, s01-038, s01-047, s04-008, s04-011, s06-025, s08-012, s10-102*
 Iyer, Vinay, *s07-042*
 Izquierdo, Daniel, *(Tue s01)16:00*
 Izquierdo, Javier, *(Tue s01)18:00, (Tue s13)18:20*
- J**
- Jablonska, Elżbieta, *(Thu 04)18:00*
 Jablonska, Anna, *(Thu 20)18:20*
 Jacas Biendicho, Jordi, *s11-039*
 Jackson, Colleen, *(Tue s07)10:10*
 Jacob, Timo, *(Mon s16)14:40, s16-027*
 Jacobse, Leon, *s16-038*
 Jäckel, Nicolas, *(Mon s08)15:00, (Tue s08)15:40, s08-033*
 Jäger, Ales, *(Tue s13)16:00*
 Jaffrezic Renault, Nicole, *s01-038*
 Jager, Edwin, *s10-040*
 Jahed, Nazeem, *s01-047, s08-012*
 Jakes, Peter, *s06-019, s10-023*
 Jambrec, Daliborka, *s03-056, s03-059*
 James, Tony D., *(Tue s01)17:00*
 Janáky, Csaba, *(Fri 10)11:10, s18-005*
 Jang, Hansaem, *s09-005*
 Janiszek, Dominika, *s03-057, s04-017*
 Jaouen, Frederic, *(Tue s07)14:00*
 Jaouen, Gérard, *(Thu 04)17:40*
 Japiassu, Kamila, *s01-021*
 Jarosz, Magdalena, *(Fri 10)09:50, s10-081*
 Jasinski, Piotr, *s04-015*
 Jaskolska, Magdalena, *s07-008*
 Jaskula, Marian, *s10-051*
 Je, Hae-June, *s06-087*
 Jebaraj, Adriel J.J., *(Wed s10)10:30*
 Jedraszko, Justyna, *(Thu 20)16:00*
 Jeerapan, Itthipon, *s01-040*
 Jehnichen, Philipp, *s06-028*
 Jembere, Solomon, *s11-011*
 Jemmett, Philip, *(Thu 03)10:10*
 Jensen, Jens Oluf, *(Tue s07)14:40*
 Jensen, Kim, *s16-012*
 Jeon, Joohee, *(Thu 04)10:10*
 Jeon, Young-Eun, *s02-037*

- Jeon, Yuju, *s06-029*
 Jeong, Beomgyun, (*Mon s07*)15:40
 Jeong, Goojin, *s06-105*
 Jeong, Gyoung Hwa, *s12-007*
 Jeong, Hwakyung, *s02-067*
 Jeong, Sung Hee, *s05-005*
 Jeppesen, Jan, (*Thu 16*)10:10
 Jeremiasse, Adriaan, *s05-009*
 Jeschull, Fabian, (*Mon s06*)14:40
 Jetzschmann, Katharina J., *s03-013*,
s03-045
 Jeuken, Lars, (*Tue s03*)09:30
 Jezowski, Pawel, (*Mon s08*)10:10,
s08-001, *s08-009*
 Ji, Chang, (*Tue s15*)09:30
 Ji, Zhuan, *s06-030*, *s06-045*
 Jia, Haiping, *s06-055*
 Jia, Yanyan, *s07-137*
 Jiang, Hua, *s07-085*
 Jiang, Xi, (*Tue s06*)18:20, (*Fri 06*)09:50
 Jiang, Yan-Xia, *s10-006*
 Jie, Shen, *s01-023*
 Jimenez-Manero, Pablo, (*Thu 06*)15:40
 Jiménez-Sandoval, Omar, *s07-125*,
s07-131
 Jin, Dandan, *s08-014*, *s08-019*
 Jin, Jian-Ting, *s06-031*
 Jinfang, Zhi, *s01-023*
 Jinhuai, Liu, *s02-038*
 Jinnouchi, Ryosuke, (*Mon s17*)15:00,
s18-012
 JinWon, Kim, *s06-120*
 Jitianu, A., (*Mon s13*)17:20, *s13-001*
 Jitvisate, Monchai, *s08-002*
 Jo, Kyusik, *s09-009*
 Jo, Yong Nam, *s06-011*
 Jönsson-Niedziolka, Martin, (*Thu 02*)15:20
 Jogdeo, Prasanna, (*Mon s13*)18:20
 Johan, Deconinck, (*Tue s13*)15:20
 Johnson, Lee, (*Fri 06*)10:10
 Johnson, Robert, *s16-047*
 Johnston, Colin, *s20-035*
 Joiret, Suzanne, (*Tue s13*)09:30
 Jolival, Claude, *s03-016*
 Jones, Bryn, *s16-039*
 Jones, Deborah, (*Tue s07*)14:00
 Jongsma, Maarten, (*Thu 02*)10:10
 Joost, Urmas, (*Thu 07*)15:20
 Jorge, Sonia Maria Alves, *s04-018*
 Jouini, Mohamed, (*Thu 10*)17:40
 Jourdin, Ludovic, *s05-008*
 Jovanovic, Primoz, (*Fri 07*)11:30, *s07-082*,
s10-015
 Ju, Wen, (*Thu 18*)16:40
 Juřfk, Tomáš, *s02-025*
 Juarez, Maria Fernanda, *s16-052*
 Juárez-Gómez, Jorge, *s09-013*
 Juhaniwicz, Joanna, (*Tue s03*)17:40
 Jukk, Kristel, (*Fri 20*)10:50
 Juma, Jamil, *s14-004*
 Junior, Archimedes, *s13-010*
 Juodkazyte, Jurga, *s10-080*
 Jusef, Hassoun, *s06-069*
- K**
 Kabanov, Artem, (*Fri 06*)11:50
 Kabanova, Tatyana, *s20-039*, *s20-041*,
s20-042
 Kacar, Ceren, *s10-091*
 Kadoma, Yoshihiro, *s06-088*, *s07-104*
 Kadowaki, Mizuki, *s06-059*
 Kadri, Abdelaziz, *s10-042*, *s13-021*,
s13-027
 Kaesche, Stefanie, *s20-034*
 Kakinuma, Katsuyoshi, (*Thu 07*)14:40
 Kakiuchi, Takashi, *s20-005*
 Kakizaki, Hirotsuka, (*Thu 18*)17:20
 Kakizawa, Yu, *s07-083*
 Kalaitzidou, Ioanna, (*Mon s11*)17:40
 Kallio, Tanja, (*Thu 07*)15:20, *s07-014*,
s07-025, *s07-085*, *s07-122*
 Kaltenboeck, Ilena, *s07-084*
 Kalyanarangan, Balaji, (*Thu 12*)14:40
 Kamat, J. V., *s02-003*
 Kamata, Tomoyuki, *s01-046*
 Kamon, Keisuke, *s20-005*
 Kanaizuka, Katsuaki, (*Fri 10*)11:30
 Kanamura, Kiyoshi, *s06-113*
 Kanayama, Yuuki, *s06-141*
 Kandhasamy, Kamaraj, (*Fri 13*)11:50
 Kang, Feiyu, *s08-023*
 Kang, Junil, *s09-009*
 Kang, Juyeon, *s01-004*
 Kang, Li-Shuo, *s15-013*
 Kang, Minkyung, (*Tue s14*)15:00,
*(Fri 02)*11:50
 Kang, Yong-Mook, *s06-061*, *s06-093*
 Kanninen, Petri, (*Thu 07*)15:20, *s07-085*
 Kanno, Yusuke, (*Mon s01*)14:40, *s02-057*
 Kanoufi, Frederic, (*Mon s15*)10:10,
*(Thu 10)*18:00
 Kapaev, Roman, *s06-096*
 Kapitanova, Olesya, *s16-043*
 Kapusta-Kolodziej, Joanna, (*Fri 10*)09:50
 Kar, Tathagata, *s10-047*
 Karaballi, Reem, (*Tue s01*)17:40
 Karabozhikova, Vasilena, *s20-031*
 Karadas, Ferdi, *s07-015*
 Karajic, A., (*Wed s03*)10:10
 Karakulina, Olesia, *s06-013*
 Karatrantos, Argyrios, *s06-100*
 Karbarz, Marcin, *s10-020*
 Karim, Waiz, (*Fri 07*)11:50
 Karlfeldt Fedje, Karin, (*Thu 05*)10:30
 Karlsson, Christoffer, (*Thu 10*)17:20,
s10-030
 Karman, Cheryl Maria, (*Thu 02*)18:00
 Karnbach, Franziska, *s07-018*
 Karpinska, Monika, *s03-057*, *s04-017*
 Karyakin, Arkady, *s03-004*, *s03-035*
 Kas, Recep, *s18-039*
 Kasian, Olga, (*Tue s07*)09:30,
*(Thu 07)*16:40, (*Fri 02*)10:50, *s10-004*
 Kasiri Bihendi, Ghoncheh, *s20-021*
 Kaspar, Robert, (*Fri 02*)11:10
 Kasuk, Heili, *s16-026*
 Kataev, Elmar, *s16-043*
 Katagishi, Kensuke, *s03-063*
 Katakya, Ritu, (*Thu 03*)09:30
 Kato, Akihiro, (*Fri 07*)09:50, *s11-030*,
s12-003
 Kato, Dai, *s01-046*
 Kato, Daiki, *s01-046*
 Kato, Masaru, *s07-086*
 Kato, Yoshitaka, (*Tue s13*)10:10
 Katogi, Akihiro, *s06-110*
 Katori, Norihiko, *s02-043*
 Katsaounis, Alexandros, (*Mon s11*)17:40,
s07-100, *s11-025*
 Katsounaros, Ioannis, *s16-004*, *s16-009*,
s16-013, *s18-023*
 Katsumata, Ken-ichi, *s03-063*
 Kauppinen, Esko, *s07-014*, *s07-025*
 Kausar Janjua, Naveed, *s02-008*
 Kautek, Wolfgang, *s10-035*
 Kavanagh, Paul, (*Tue s03*)15:00
 Kavunga, Sunil, *s18-026*
 Kawahara, Takuto, *s10-007*
 Kawamura, Ryutaro, *s02-013*
 Kawaura, Hiroyuki, (*Wed s16*)10:10
 Kawk, Da-Hee, *s10-065*
 Kay, Nicola, (*Thu 16*)10:10
 Kayran, Yasin Ugur, *s03-056*, *s07-143*
 Kayser, Steffen Alexander, (*Mon s06*)15:00
 Kazda, Tomas, *s06-032*
 Kazimierzczak, Honorata, (*Mon s13*)14:00
 Kazuyuki, Yoda, (*Thu 12*)14:40
 KC, Chandra B., (*Mon s03*)17:00
 Kebede, Noah, *s01-005*
 Keeler, Alexander, *s07-087*
 Keeley, Gareth P., (*Tue s07*)09:30
 Kekedy-Nagy, Laszlo, *s03-040*
 Keles, Turgut, *s10-099*
 Keller, Jürg, *s05-008*
 Keller, Marlou, (*Mon s06*)15:20
 Kenis, Paul, (*Mon s11*)18:00
 Kéranguéven, Gwénaëlle, (*Thu 07*)17:00
 Kern, Klaus, *s07-076*
 Kerr, Emily, *s20-052*
 Kerwald, Jonas, (*Thu 12*)16:00
 Keszelióvá, Daniela, *s15-041*
 Keurentjes, J.T.F., (*Mon s11*)09:50
 Khairullina, Dinara, *s10-032*
 Khan, Azam, *s18-021*
 Khare, Chinmay, (*Fri 20*)09:30
 Khazi, Isman, *s01-024*
 Khodayari, Mehdi, *s20-007*
 Khouider, Ali, *s16-016*
 Kibena-Pöldsepp, Elo, (*Fri 20*)11:10,
s10-049
 Kibler, Ludwig, (*Mon s16*)14:40
 Kiliyas, George, *s07-100*
 Kilic, Esma, *s10-089*, *s10-091*
 Kim, Ayoung, *s06-033*, *s06-105*
 Kim, Bongkyu, *s03-020*, *s05-006*
 Kim, Byoung Gak, *s08-034*
 Kim, Byung-Kook, *s06-087*
 Kim, Dong-Min, *s06-122*
 Kim, Dong-Wan, *s06-087*
 Kim, Duri, *s06-021*, *s06-034*
 Kim, Eun Joong, (*Thu 04*)10:10
 Kim, Eunok, *s12-011*
 Kim, Hak-Sung, (*Tue s08*)17:00
 Kim, Hansu, *s06-033*, *s06-105*
 Kim, Hasuck, *s07-001*
 Kim, Ho Young, *s07-016*
 Kim, Hyea, (*Mon s06*)16:00
 Kim, Hyeyun, *s06-035*
 Kim, Hyun Soo, *s06-121*
 Kim, Jaekwang, *s12-007*, *s12-011*
 Kim, Jayoung, *s03-060*
 Kim, Jongwon, *s02-067*
 Kim, Joosun, *s06-087*
 Kim, Ki-Bum, (*Thu 02*)16:40
 Kim, Kiyoul, *s06-133*, *s20-022*
 Kim, Min-Cheol, *s10-062*, *s10-064*,
s10-065
 Kim, Nayoung, *s07-088*

- Kim, Sang-Wook, *s12-007*
 Kim, Seon-Min, *s06-121*
 Kim, Si-Jin, *s10-062, s10-064, s10-065*
 Kim, Soo-Kil, *s07-016*
 Kim, Soochan, *s02-068, s02-069, s07-017*
 Kim, Suhee, *s02-039*
 Kim, Tae-Ho, *s08-034*
 Kim, Taeyoung, *s09-009*
 Kim, Won Bin, *s02-068, s02-069, s07-017*
 Kim, Young-Jun, *s06-011, s06-105*
 Kinumoto, Taro, *s06-141*
 Kirakosyan, Serezha, *s07-056*
 Kishimoto, Haruo, *s07-145*
 Kisu, Kazuaki, *(Tue s08)14:20*
 Kitamura, Kanae, *s01-006*
 Kizling, Michał, *(Wed s03)10:30 s03-026*
 Kjeang, Erik, *(Thu 07)15:00, (Thu 12)17:00, s12-004*
 Klaver, Peter, *s17-014*
 Kleebe, Hans-Joachim, *(Tue s07)15:20*
 Klein, Jens, *s02-070*
 Klein, L.C., *(Mon s13)17:20, s13-001*
 Klemm, Elias, *s18-020*
 Klerk, Niek, *s06-139*
 Klett, Matilda, *s06-070, s06-075*
 Klink, Stefan, *s01-045, s07-003*
 Klöpsch, Richard, *s06-055*
 Knapp, Michael, *s06-010*
 Knights, Shanna, *(Thu 12)14:00*
 Knittel, Peter, *(Fri 20)09:50, (Fri 02)11:30*
 Knotek, Petr, *(Tue s13)16:00*
 Ko, Jeongsik, *(Tue s06)10:30*
 Kobayashi, Ryo, *s06-088*
 Koca, Atif, *s10-077, s10-078, s10-099*
 Koch, Aljoscha, *s05-002*
 Koch, Christin, *(Mon s13)18:20*
 Koch, Stephan, *s06-112*
 Koczur, Kallum M., *(Tue s15)09:30*
 Koczwara, Christian, *(Tue s08)15:40*
 Kodali, Mounika, *s05-001*
 Kodama, Kensaku, *(Mon s17)15:00*
 Kodym, Roman, *s07-067*
 Köcher, Simone S., *s17-009*
 Koenigseder, Alexander, *s06-038*
 Koga, Kazunori, *s10-070*
 Kohno, Yuji, *(Fri 07)09:50, s01-018, s11-030, s12-003*
 Kohring, Gert, *s11-056*
 Kohsakowski, Sebastian, *s10-008*
 Koike, Taisuke, *(Tue s13)10:10*
 Koironen, Tuomas, *s10-039*
 Kokoh, Koaukou Boniface, *s07-065, s07-139, s16-021*
 Kolb, Manuel, *(Mon s16)15:40, s17-008*
 Kollender, Jan Philipp, *(Tue s13)14:20, s04-016*
 Kolodziej, Adam, *(Thu 10)15:40, s08-020*
 Komaba, Shinichi, *s06-101, s06-110*
 Komkova, Maria, *s03-004, s03-035*
 Kondo, Hiroki, *(Wed s16)10:10*
 Kondo, Takeshi, *s03-063*
 Kondo, Yasuhito, *(Wed s16)10:10*
 Konev, Dmitry, *(Thu 10)14:40, s07-028, s10-031, s10-032, s10-037, s15-010, s17-012*
 Kongi, Nadezda, *(Fri 20)10:50*
 Konkana, Bharathi, *(Thu 10)15:00, s07-089*
 Kontos, Athanassios G., *s02-034*
 Koo, Bon-Min, *(Thu 06)14:40*
 Koo, Boram, *s12-006*
 Kooyman, Patricia J., *(Mon s07)17:40*
 Koper, Marc, *(Mon s11)10:10, (Mon s16)15:40, (Mon s07)17:40, (Tue s16)14:20, (Fri 13)11:10, s15-026, s15-029, s15-038, s16-004, s16-007, s16-009, s16-013, s16-015, s16-023, s16-038, s17-005, s17-008, s18-015, s18-016, s18-018, s18-023*
 Kopiec, Gabriel, *(Thu 18)14:40, (Thu 10)17:00*
 Kopljär, Dennis, *s18-020*
 Korchev, Yuri, *s01-017*
 Kornyshev, Alexei A., *(Mon s17)09:30, (Mon s17)10:10*
 Korte, Carsten, *s06-028, s06-136, s07-135, s20-006*
 Korth, Martin, *(Mon s08)14:40*
 Kortlever, Ruud, *(Mon s07)17:40, s18-015*
 Kosek, Juraj, *s07-037, s07-038, s07-041*
 Kosmidou, Theodora, *(Thu 12)15:20*
 Kobmann, Jörg, *s07-089*
 Kostecki, Robert, *(Tue s06)14:20*
 Kostuchenko, Zinaida, *s17-002*
 Kotani, Akira, *s01-006*
 Kotoulas, Ioannis, *s20-023*
 Kotronia, Antonia, *(Thu 06)15:40*
 Kottrup, Konstantin, *s15-022*
 Kotzianova, Adela, *s01-049*
 Kovář, David, *s02-025*
 Koyama, Yukinori, *(Fri 06)11:50*
 Koz, Cevriye, *s06-036*
 Kozlova, Ekaterina, *s01-051*
 Kraatz, Heinz-Bernhard, *(Thu 02)17:20*
 Kraljić Roković, Marijana, *s10-085*
 Kramer, Denis, *(Mon s07)17:20, (Tue s07)10:10*
 Kramm, Ulrike I., *(Tue s07)15:20, (Thu 07)16:00, s18-024*
 Kranz, Christine, *(Tue s01)18:00, (Fri 20)09:50, (Fri 02)11:30*
 Krause, Andreas, *(Thu 10)18:00*
 Krause, Kay J., *(Tue s03)16:40*
 Krause, Philipp P. T., *s16-010*
 Krbal, Milos, *s10-044*
 Kremliakova, Natalia, *s07-124*
 Krischer, Katharina, *(Mon s13)09:30, (Tue s16)10:30*
 Krischok, Stefan, *s06-027, s06-047*
 Krishna, Katla Sai, *s10-071*
 Krishna, Muthu, *s07-035*
 Kristan Mioc, Ekatarina, *(Mon s13)15:20, s13-020, s13-020*
 Kristianto, Hans, *s08-008*
 Kriston, Akos, *(Thu 12)15:20, s06-058*
 Kromer, Mathew, *(Thu 10)15:40*
 Krtil, Petr, *s11-053*
 Krüner, Benjamin, *s08-033*
 Krummacker, Jakob, *(Mon s08)14:40*
 Kruszewski, Marcin, *(Mon s03)16:00*
 Kruusenberg, Ivar, *(Thu 07)15:20*
 Krysiak, Olga, *(Mon s07)18:00, (Thu 20)16:00*
 Krzak, Agata, *(Mon s03)16:00*
 Kuang, Yafei, *s06-115*
 Kubas, Adam, *(Mon s03)10:10*
 Kube, Alexander, *s06-089*
 Kubicki, Maciej, *s15-024*
 Kubota, Kei, *s06-101, s06-110*
 Kubota, Lauro, *(Mon s01)09:50, s10-092, s11-041*
 Kucernak, Anthony, *(Tue s07)15:00*
 Kucinskis, Gints, *(Mon s06)17:20*
 Kudou, Kouichi, *s14-011*
 Kudrak, Edward, *(Fri 13)11:50*
 Kudu, Omer Ulas, *s06-036*
 Kühl, Stefanie, *s07-059*
 Kühn, Laura, *(Tue s07)18:00*
 Künzel, Felix, *s13-005*
 Kuhn, Alexander, *(Mon s01)15:20, (Tue s03)18:20, (Wed s03)10:10, (Thu 10)10:10*
 Kuhn, Annemarie, *s20-045*
 Kuhri, Susanne, *s06-028, s07-135*
 Kulesza, Pawel J., *(Tue s08)16:40, (Thu 10)16:00, (Thu 18)16:00, s02-009, s03-009, s03-057, s04-017, s10-012, s15-021, s15-024, s16-005, s18-006*
 Kulikovskiy, Andrei, *(Mon s17)17:20*
 Kulkarni, Ashish, *(Mon s13)15:00*
 Kulkarni, Jaideep, *(Mon s13)15:00*
 Kulova, Tatiana, *s06-063, s06-096, s06-104*
 Kulp, Christian, *s07-134*
 Kulp, Katarzyna, *s07-134*
 Kulyk, Nadiia, *(Tue s07)09:30, s07-082, s07-090*
 Kumakura, Shinichi, *s06-101*
 Kumar Nune, Satya Vijaya, *s07-015*
 Kun, Robert, *(Thu 06)14:20, (Fri 06)11:10*
 Kungl, Hans, *(Mon s06)15:00, s06-019, s10-023*
 Kunikata, Ryota, *(Mon s01)14:40*
 Kuntke, Philipp, *s05-009*
 Kuo, Chia-Heng, *s10-082*
 Kuragano, Asako, *s03-063*
 Kure-Chu, Song-Zhu, *(Fri 13)11:30, s10-007*
 Kurek, Stefan, *s01-042, s01-052*
 Kurihara, Masato, *(Fri 10)11:30*
 Kurowska-Tabor, Elzbieta, *(Fri 10)09:50*
 Kurtanidze, Rusudan, *s15-017*
 Kusakabe, Masato, *s07-120*
 Kushi, Takuto, *(Fri 07)10:10*
 Kushibiki, Kanshi, *s07-071*
 Kusu, Fumiyo, *s01-006*
 Kutner, Włodzimierz, *(Mon s03)17:00*
 Kuzmenko, Volodymyr, *s06-035*
 Kuzmina, Olga, *s11-048*
 Kvaratskhelia, Elene, *s15-017*
 Kvarnström, Carita, *s08-028, s10-084*
 Kwak, Da-Hee, *s10-062, s10-064*
 Kwiatkowski, Maciej, *(Fri 10)10:50*
 Kwok, Stephen Chin To, *s16-034*
 Kwon, Hyuk Jae, *(Tue s06)10:30*
 Kwon, Mi-Sook, *s06-102*
 Kwon, Youngkook, *(Mon s16)15:40, (Fri 18)11:30*
 Kyratzis, Ilias, *(Fri 13)09:50*
- L**
 La Mantia, Fabio, *s20-021*
 Laasonen, Kari, *s07-025, s17-003*
 Labbé, Eric, *(Mon s15)15:00, s01-013*
 Labbé, Fabien, *(Tue s07)09:50*
 Laborda, Eduardo, *(Thu 20)10:10, s01-037*

- Laborde, Cecilia, (*Thu 02*)10:10
 Lacey, Matthew J., (*Mon s06*)14:40
 Lacôte, Emmanuel, (*Thu 10*)15:00
 Lado, Julio, s09-008
 Läll, Laura, s16-041
 Lämmel, Christoph, s01-003
 Lagonotte, Patrick, s06-067
 Lagrost, Corinne, (*Thu 20*)15:00, s15-015
 Lahiri, Abhishek, s06-037
 Lahodny-Sarc, Olga, s13-026
 Lai, Shun-Yi, s10-082
 Lai, Stanley C.S., s07-055
 Lakshminarayanan, V., s02-071
 Lalère, Fabien, (*Thu 06*)17:00
 Laluc, Claire, s13-011
 Lamaka, Sviatlana V., (*Tue s13*)17:20, (*Wed s13*)09:30
 Lamberti, Andrea, s11-029, s16-049, s18-004
 Lamibrac, Adrien, s07-083
 Lammer, Michael, s06-038
 Lamy, Claude, (*Thu 07*)09:50
 Lan, Yandi, (*Tue s11*)14:40
 Landaeta, Esteban, s18-011
 Landgraf, Steffen, s06-129, s06-130
 Landon, James, (*Tue s09*)17:20
 Landsmann, Steve, (*Thu 20*)17:40, s10-058
 Landstorfer, Manuel, s17-010
 Langer, Frederieke, (*Thu 06*)14:20, (*Fri 06*)11:10
 Langford, Steven J., s04-004
 Langklotz, Ulrike, (*Thu 10*)18:00
 Langner, Joachim, (*Wed s07*)09:30, s07-039
 Lankiang, Styven, s07-091
 Lannebère, Sylvain, (*Wed s05*)10:30
 Lannelongue, Jérémy, (*Thu 10*)10:10
 Lapeyre, Veronique, (*Mon s01*)15:20
 Lapique, François, (*Mon s11*)15:20, (*Thu 12*)16:00, s11-027
 Lara Beltram, Matias, s03-024
 Larios Durán, Erika Roxana, (*Mon s03*)15:20
 Laskos, Andreas, s07-048
 Lassi, Ulla, s07-122
 Latroche, Michel, (*Thu 10*)14:40, s10-056
 Latsuzbaia, Roman, s11-012
 Latz, Arnulf, (*Thu 06*)15:20, (*Thu 06*)15:20, (*Thu 12*)18:00, s06-124, s06-131, s16-053
 Laumen, Jennifer, s07-048
 Launay, Jerome, (*Thu 04*)17:20
 Laurent, Barbara, (*Tue s13*)14:40
 Laurent, Michel, (*Thu 10*)14:40, s10-056
 Lauria, Alessandro, (*Tue s14*)17:40
 Lauro, Federico M., s02-007
 Lavelaine, Hervé, (*Mon s11*)15:20, (*Tue s11*)14:20
 Lavielle, Solange, s01-013
 Lavrijsen, Reinoud, s02-061
 Lazar, Ioana-Georgiana, s15-020
 Lazarescu, Mihai F., s20-015
 Lazarescu, Valentina, s20-015
 Lázaro, M^a Jesús, s07-114
 Lazenby, Robert, s03-046
 Lazerges, Mathieu, s03-051
 Lê, Aurore, (*Fri 07*)11:30
 Le Goff, Alan, s10-088
 Le Mercier, Thierry, (*Mon s08*)15:40
 Le Naour, Claire, (*Thu 20*)15:20
 Le, Thi-Xuan-Huong, s09-012
 Leach, Andrew, s10-093
 Leary, Edmund, (*Thu 16*)10:10
 Lebedeva, Natalia, s06-039, s06-039, s06-040
 Leclere, Mélody, (*Mon s06*)17:40
 Ledesma-García, Janet, s07-052, s07-053, s07-054
 Ledezma, Pablo, s05-008
 Lee, Ah-Jung, s06-105
 Lee, Chong-Yong, (*Tue s03*)09:30
 Lee, Chuan-Pei, s12-005
 Lee, Dong Hoon, s07-088
 Lee, Dong-Gyu, s20-028
 Lee, Eun-Su, s07-088
 Lee, Gibaek, s06-111
 Lee, Gwang-Hee, s06-087
 Lee, Gyu-Ho, s10-064, s10-065
 Lee, Ha-Young, s12-008
 Lee, Heung Chan, (*Tue s06*)10:30
 Lee, Hye Jin, s01-007, s02-039
 Lee, Ilbok, s12-007, s12-011
 Lee, Jae Gyeong, s14-013, s16-035
 Lee, Jae Kwang, s09-005
 Lee, Jaemin, s20-020, s20-022, s20-024, s20-025
 Lee, Jaeyoung, (*Mon s07*)15:40, s09-005
 Lee, Jeong-Seon, s06-018
 Lee, Jim Yang, (*Tue s06*)18:20, (*Fri 06*)09:50
 Lee, Jin-Young, s14-013, s16-035
 Lee, Jong-soo, s08-013
 Lee, Joong Kee, s08-008
 Lee, Juhan, (*Tue s08*)15:20
 Lee, Jung-Tae, (*Mon s06*)16:00
 Lee, Kidan, (*Thu 02*)16:40
 Lee, Lita, (*Thu 10*)18:20
 Lee, Moo-Seok, s07-088
 Lee, Patricia, s20-035
 Lee, Pei-Tzu, (*Fri 13*)10:50, s13-003, s13-003
 Lee, Sang Ha, s02-068, s02-069, s07-017
 Lee, Sang Hyun, (*Tue s08*)17:00
 Lee, Sang-Min, s06-121
 Lee, Seun, s06-087
 Lee, Soo Youn, s05-005
 Lee, Sunmi, s14-013
 Lee, Yong-Gun, s06-123
 Lee, Yoo Seok, s03-020, s05-006
 Lee, Youngkwan, s02-068, s02-069, s07-017
 Lee, Yu-Wei, s11-026, s13-003, s14-014
 Leech, Donal, (*Tue s03*)09:50, (*Tue s03*)15:00, (*Wed s03*)10:00, (*Wed s03*)10:40, (*Thu 18*)15:40
 Lefèvre, Grégory, (*Mon s13*)09:50
 Lefterova, Elefteria, s07-005
 Léger, Christophe, (*Mon s03*)10:10, (*Tue s03*)14:40, (*Thu 18*)14:40
 Legrand, Louis, (*Tue s09*)14:00
 Lehnert, Werner, s07-135, s20-006
 Leimkühler, Silke, s03-048
 Lein, Tobias, (*Thu 10*)18:00
 Leisegang, Tilmann, (*Fri 06*)11:50
 Leitch, J. Jay, s04-013
 Leite, Karla Carneiro de Siqueira, s01-053, s04-028
 Leiva, Ezequiel Pedro Marcos, s06-041, s06-042, s06-051, s06-052
 Leleu, Samuel, s13-014
 Lemaître, Frédéric, (*Thu 04*)17:40, s01-013, s04-030
 Lemay, Serge, (*Thu 21*)08:15, (*Thu 02*)10:10, s17-002
 Lemercier, Gabriel, (*Thu 04*)17:20
 Lemos, Sherlan S., s02-059
 León Sotelo, María Isabel, s07-036
 Leonard, Nathaniel, (*Thu 07*)17:20
 Leontidou, Tina, (*Thu 02*)16:40
 Lesch, Andreas, s07-092
 Lesowiec, Judith, (*Mon s08*)16:40
 Lespes, Nicolas, (*Mon s17*)14:40
 Lettenmeier, Philipp, (*Mon s07*)18:20
 Letterio, Michael, (*Fri 02*)11:10
 Leung, Benjamin, s11-046
 Levchenko, Alexey, s06-015
 Levecque, Pieter B. J., (*Tue s07*)10:10
 Levi, Mikhael, (*Wed s10*)09:30
 Levitskiy, Oleg, s15-018
 Levkin, P., (*Mon s01*)15:00
 Levon, Kalle, s03-052
 Lew-Yee, Juan Felipe Huan, s20-013, s20-014
 Lewis, Jennifer, s07-042
 Leyk, Janina, s04-026
 Li, Chun-Ting, s12-005
 Li, Fengwang, (*Fri 18*)11:50, s04-004, s18-021
 Li, Haidong, (*Mon s15*)18:00, (*Tue s01*)17:00
 Li, Huaiguang, (*Tue s03*)14:40, s03-005
 Li, Jian, s06-014
 Li, Jian-Feng, s16-045
 Li, Jiezheng, s01-002, s01-008
 Li, Jingfa, (*Tue s06*)18:20
 Li, Jun-Tao, s06-022
 Li, Meixian, s02-005
 Li, Qingfeng, (*Tue s07*)14:40
 Li, Qiyang, s06-030, s06-045
 Li, Suping, s04-012
 Li, Tao, s08-014, s08-015, s08-019
 Li, Tianshu, (*Tue s13*)15:00
 Li, Xianji, (*Fri 06*)09:30
 Li, Xiaogang, s13-019
 Li, Xiaowei, (*Mon s15*)15:40
 Li, Xiaoxia, s06-043
 Li, Xiuting, s02-006
 Li, Yamei, s15-027
 Li, Yang, s06-044
 Li, Ying, (*Tue s13*)15:00, (*Thu 02*)17:40
 Li, Yuanhui, (*Mon s03*)14:40
 Li, Yun, (*Thu 04*)17:40, s04-030
 Liang, Banglei, s08-014, s08-015, s08-019
 Liang, Peng, (*Tue s09*)10:10
 Liang, Teh-Ming, s09-023
 Liao, Guangyue, (*Mon s08*)17:20
 Liao, Ying-Cih, s10-094
 Licklederer, Markus, s20-026, s20-027
 Lillethorup, Mie, s18-010
 Lilloja, Jaana, (*Fri 20*)11:10
 Lim, Calvin, (*Thu 18*)18:00
 Lim, Jinsub, s06-018
 Lim, Sung-Chul, s06-119
 Lima, Lucas Carvalho, s01-039
 Lima, Ruitter Moraes, s04-027, s04-028
 Lima-Neto, Pedro, s13-010
 Limson, Janice, s03-054, s04-007
 Limtrakul, Jumras, (*Mon s01*)15:20

- Lin, Huan-Ting, (*Mon s06*)16:00
 Lin, Jeng-Yu, *s08-035, s14-001*
 Lin, Kai-Qiang, *s16-045*
 Lin, Ling, (*Tue s07*)14:20
 Lin, Shih Chien, *s10-094*
 Lin, Tsung-Wu, *s08-035*
 Lin, Wen-Feng, (*Thu 07*)15:40, *s07-093, s07-112*
 Lin, Xiao, (*Thu 07*)15:40, *s07-093*
 Lin, Yan, *s06-023*
 Lin, Yan-Fen, (*Thu 20*)17:20
 Lindahl, Niklas, (*Tue s07*)17:20
 Lindberg, Simon, *s08-010*
 Lindbergh, Göran, *s06-017, s06-070, s06-075*
 Lindfors, Tom, (*Thu 10*)16:40, *s03-052*
 Lindgren, Fredrik, (*Mon s06*)14:40, (*Thu 16*)09:50
 Linke, Alexander, *s20-007*
 Linnartz, Christian, (*Tue s09*)15:00
 Lipkowski, Jacek, (*Wed s03*)10:20, (*Thu 03*)09:50, *s04-013*
 Lippert, Sara, (*Tue s03*)18:00
 Lisdat, Fred, (*Tue s03*)18:00, (*Thu 18*)15:20, *s03-006, s03-006, s03-024*
 Liska, Alan, (*Mon s15*)16:00
 Lisowska-Oleksiak, Anna, *s08-036, s18-022*
 Little, R. Daniel, (*Mon s15*)09:30, *s15-013*
 Liu, Baohong, *s01-036*
 Liu, Bi-Ju, *s16-045*
 Liu, Can, (*Tue s16*)14:40, *s06-095, s16-040*
 Liu, Chi-Yang, *s07-095, s07-096*
 Liu, Dandan, (*Wed s05*)10:10
 Liu, Danqing, *s16-025*
 Liu, G., (*Tue s06*)14:20
 Liu, Huakun, *s06-086*
 Liu, Hung-Cheng, *s14-006*
 Liu, Jianguo, *s07-094*
 Liu, Jianyun, (*Tue s09*)17:40, *s02-040*
 Liu, Kunlei, (*Tue s09*)17:20
 Liu, Li, (*Tue s13*)15:00
 Liu, Liang, (*Thu 20*)15:40
 Liu, Po-I., *s09-023*
 Liu, Run, *s14-009*
 Liu, Wan-Yun, (*Thu 02*)17:40
 Liu, Wei, (*Tue s07*)18:00
 Liu, Xiaoxia, *s08-027*
 Liu, Yang, (*Fri 02*)11:30
 Liu, Yingjia, *s06-134, s06-135*
 Liu, Yu-Hsuan, (*Tue s09*)18:00
 Liu, Yujie, *s01-036*
 Liu, Yun, *s01-036*
 Liu, Yuqing, (*Tue s08*)17:40
 Liu, Zhiyong, *s13-019*
 Lizgina, Ksenia V., *s10-037*
 Ljubek, Gabrijela, *s10-085*
 Llanos, Javier, (*Tue s11*)10:30, (*Tue s11*)10:30, *s11-042, s20-040*
 Lo Faro, Massimiliano, *s07-127*
 Lo, S-C., *s18-031*
 Lobato, Justo, (*Mon s11*)14:40, *s05-003, s05-004*
 Lobo-Castañón, María Jesús, (*Mon s03*)15:40
 Lobón, Germán Sanz, *s04-027, s04-028, s09-010*
 Locatelli, Cristina, *s10-011, s16-014*
 Lockwood, Colin, (*Tue s03*)09:30
 Löwen, Hartmut, (*Mon s17*)17:40
 Loftager, Simon, (*Mon s17*)18:20
 Lohmann, Felix P., *s07-097*
 Lojou, Elisabeth, *s03-007*
 Loke, Seng, (*Mon s01*)09:30
 Lombardo, Salvatore, *s07-010, s07-011*
 London, Gábor, *s18-005*
 Long, Nicholas, *s15-025*
 Long, Xiao, *s08-044*
 Loosveldt, Johanna, (*Thu 20*)15:00
 Lopes da Silva, Amison Rick, *s11-028*
 Lopes, Isabela, *s01-053*
 Lopes, Thiago, (*Tue s07*)15:00
 López, Conrado, *s11-042*
 Lopez De Lacey, Antonio, *s03-017*
 Lopez, Francesca, *s03-021*
 López, Montse, *s16-044*
 López-Cudero, Ana, (*Fri 06*)11:30
 López-León, Servando, (*Thu 20*)15:20
 López-Luke, Tzarara, *s12-009*
 Lopez-Montero, Ivan, (*Mon s03*)10:30
 López-Oyama, Ana B, *s13-012*
 López-Vizcaíno, Rubén, *s11-008*
 Lorandi, Francesca, (*Mon s15*)17:40, *s15-007, s15-008, s15-009*
 Lorcy, Dominique, (*Mon s15*)10:30
 Lota, Grzegorz, *s08-016, s08-017*
 Lota, Katarzyna, *s08-007, s08-016, s08-017*
 Lotowska, Weronika A., *s03-009*
 Lottin, Olivier, (*Thu 07*)15:00
 Lourencao, Bruna C., *s01-025*
 Low, Paul, (*Thu 16*)10:10
 Low, Ze-Xian, *s02-032*
 Lu, Cong, (*Thu 04*)17:40
 Lu, Huiran, *s06-035*
 Lu, Kedan, *s14-009*
 Lu, Ping, *s11-046*
 Lu, Qinyan, *s14-009*
 Lu, Yang, *s05-008*
 Lu, Yaxiang, *s07-098*
 Lubitz, Wolfgang, (*Tue s03*)14:40, *s03-050*
 Lucas, Dominique, *s10-037, s15-010*
 Lucas-Granados, Bianca, *s10-060, s10-061, s10-066, s10-067*
 Lucht, Brett, (*Mon s06*)14:00
 Ludvík, Jiří, (*Mon s15*)16:00, *s15-014, s15-016, s15-033*
 Ludwig, Alfred, (*Mon s01*)15:00, (*Thu 07*)16:40, (*Fri 20*)09:30
 Ludwig, Roland, *s02-054, s03-015, s03-019, s03-047*
 Lueck, Jessica, *s06-124*
 Lueke, Wiebke, *s07-022*
 Lüsü, Madis, *s16-006*
 Lugli, Francesca, (*Thu 04*)14:40
 Lukaczyńska, Monika, *s14-010*
 Lukasiewicz, Magdalena, *s03-058*
 Lukawska, Malgorzata, *s03-058*
 Lunden-Bell, Ruth M., *s06-026*
 Luo, Fang, (*Thu 07*)17:20
 Luo, Jiayan, *s08-023*
 Luo, Jingshan, (*Thu 20*)17:40, (*Fri 18*)11:10
 Luo, Zhishan, (*Fri 18*)10:10
 Luong, Nguyen Dang, *s07-085*
 Luque, Guillermina, *s06-041, s06-042*
 Lust, Enn, *s16-026, s16-041*
 Luspai, Karol, *s15-041*
 Lv, Li-Ping, (*Wed s13*)10:30
 Lyalin, Andrey, (*Mon s16*)18:20
 Lycoops, Jess, (*Thu 16*)10:10
 Lyonard, Sandrine, (*Mon s06*)17:40
 Lyubimov, Victor, *s20-039, s20-041*
- ## M
- Ma Andersen, Shuang, *s07-070*
 Ma, C. A., *s07-093*
 Ma, Chaoxiong, (*Wed s02*)10:10
 Ma, Chih-Yu, *s11-006*
 Ma, Hongyun, *s08-023*
 Ma, Liwei, (*Mon s01*)18:00
 Ma, Su, *s03-019, s03-047*
 Ma, Xin-Hui, *s06-031*
 Ma, Xingyu, *s10-021*
 Ma, Yanwei, *s08-031*
 Ma, Yue, (*Mon s06*)10:10
 Maawad, Emad, *s06-010*
 Macak, Jan M., (*Tue s13*)16:00, *s10-044*
 Macedo, Isaac, *s01-053*
 MacFarlane, Douglas, (*Tue s06*)09:30, (*Thu 20*)14:40, (*Fri 18*)11:50, *s06-083, s14-005, s18-021*
 Machado, Rúbia, *s20-053*
 Machado, Sergio, *s02-042*
 Machata, Peter, *s15-042*
 Machini, Wesley Bruno Silva, *s04-018*
 Machuca-Martínez, Fiderman, *s11-010*
 Maciej, Artur, *s13-004*
 Mackiewicz, Marcin, *s10-020*
 MacLoughlin, Ronan, (*Fri 02*)10:10
 Macpherson, Julie, *s16-025, s17-013*
 Maddar, Faduma, *s03-046*
 Madier, Ludovic, *s06-067*
 Mänttari, Mika, *s10-039*
 Maevsky, Eugene, *s15-005*
 Magagnin, Luca, *s10-046*
 Magasinski, Alexandre, (*Mon s06*)16:00
 Magdesieva, Tatiana, *s15-018*
 Magner, Edmond, (*Wed s03*)10:00, *s03-010*
 Magnussen, Olaf, (*Tue s14*)14:40
 Mahne, Nika, (*Thu 06*)17:20
 Mahrholz, Thorsten, (*Mon s08*)17:20
 Mai, Sebastian, *s06-047*
 Maia, Gilberto, (*Fri 20*)11:10
 Maibach, Julia, (*Thu 16*)09:50
 Maier, Joachim, (*Mon s06*)17:20
 Maillard, Florian, *s06-067*
 Maillard, Frédéric, (*Tue s07*)09:50, (*Tue s07*)17:40, (*Fri 07*)10:10, *s07-099*
 Mais, Laura, *s18-028*
 Maj-Zurawska, Magdalena, *s03-057, s03-058, s04-017*
 Majima, Wataru, *s07-009*
 Makhlooghiazad, Faezeh, (*Tue s06*)09:30
 Makri, Marialena, (*Mon s11*)17:40
 Malacrida, Paolo, (*Mon s16*)15:00
 Malara, Francesco, *s10-011, s16-014*
 Maldonado, Stephen, (*Thu 10*)09:30
 Maldonado, Teresita, *s15-034*
 Malek, Ali, (*Wed s16*)09:30
 Malewski, Yvonne, *s18-015*
 Malko, Daniel, (*Tue s07*)15:00
 Malladi, Sairam Krishna, (*Tue s01*)14:40
 Mallet, Jean-Maurice, (*Mon s15*)15:00

- Malpass-Evans, Richard, *s02-011, s02-032, s02-077*
- Maltseva, Alina, (*Mon s13*)09:50
- Maltz, Alberto, *s16-051*
- Malvankar, Nikhil, (*Thu 05*)09:30
- Mamme, Mesfin Haile, *s20-061*
- Mandler, Daniel, (*Thu 02*)14:40, (*Thu 20*)15:40, *s02-051*
- Mangold, Klaus-Michael, *s07-047*
- Mano, N., (*Wed s03*)10:10, *s03-007*
- Manolescu, Dorina, *s07-124*
- Manriquez, Juan, *s09-014, s18-013*
- Mansuy, Christelle, *s01-013*
- Manzanares, Jose, *s17-003*
- Manzano, Cristina V., (*Tue s14*)17:40
- Mao, Bing-Wei, (*Thu 16*)10:10
- Marandi, Margus, *s10-049*
- Maranzana, Gael, (*Thu 07*)15:00
- Marasso, Simone, *s16-049*
- Marcaccio, Massimo, (*Fri 10*)10:10, *s15-037*
- Marcantoni, Enrico, *s06-048*
- Marchal, Wouter, *s06-082*
- Marchini, Florencia, (*Wed s09*)10:10
- Marcilla, Rebeca, (*Tue s08*)18:00, (*Thu 09*)09:50
- Marcin, Molenda, *s10-072*
- Mardel, James, (*Fri 13*)09:50
- Marinescu, Monica, (*Thu 12*)15:40, (*Fri 06*)10:50
- Mark, Andreas, (*Tue s01*)18:20
- Mark, Melanie D., *s04-031*
- Marken, Frank, (*Thu 07*)14:00, (*Thu 02*)14:00, *s02-011, s02-032, s02-077*
- Markova, Eva, *s03-051*
- Markovic, Nikola, *s03-022, s06-091*
- Marlier, Pascal, (*Mon s11*)15:20
- Maroni, Fabio, *s06-048*
- Marques, Marta C., (*Mon s03*)10:30
- Marquez, Ileana, (*Mon s03*)10:30
- Marquez, Inmaculada, *s03-041*
- Márquez-León, Jessica, *s10-096*
- Marquitan, Miriam, *s01-017, s04-031*
- Marriaga-Cabrales, Nilson, *s11-010*
- Marshall, Aaron, (*Tue s13*)10:30, (*Thu 18*)18:00
- Marsili, Enrico, (*Mon s13*)18:20, *s02-007*
- Martemianov, Serguei, *s06-067*
- Martín de Vidales, María J., (*Tue s11*)16:00
- Martin, Pierre, *s06-046*
- Martín, Santiago, (*Thu 16*)10:10
- Martinaiou, Ioanna, (*Tue s07*)15:20
- Martinez, Francisco, *s01-032, s03-036*
- Martinez Hincapie, Ricardo, (*Mon s16*)14:00
- Martinez, Ulises, (*Tue s07*)14:20
- Martinez-Botas, Ricardo, (*Thu 12*)15:40
- Martínez-González, Eduardo, *s05-010*
- Martinez-Guerra, Eduardo, *s07-115, s07-121*
- Martínez-Huerta, M^a Victoria, *s07-113, s07-114*
- Martinez-Huitle, Carlos Alberto, (*Tue s11*)15:00, (*Tue s11*)17:00, *s09-016, s11-020, s11-021, s11-022, s11-028, s11-038, s11-057, s16-037, s16-052*
- Martinez-Mora, Omar, *s15-011*
- Martinez-Moreno, Elias, (*Mon s07*)10:10
- Martínez-Ortiz, Francisco, (*Thu 20*)10:10
- Martino, Eftychia, *s07-100*
- Martins, Caue Alves, *s16-008*
- Martins Gonçalves, Josué, *s02-004*
- Martins, Maria Elisa, *s16-008*
- Martins, Mariana, *s09-008*
- Martins, Rui C., *s11-019, s11-020*
- Martins, Vitor L., (*Mon s08*)16:40, *s08-005*
- Martucci, Alessandro, *s07-074*
- Maruyama, Jun, *s06-090*
- Maruyama, Yuki, *s06-049*
- Marzun, Galina, *s10-008*
- Masa, Justus, (*Mon s01*)16:00, (*Thu 10*)15:00, (*Thu 07*)18:20, *s06-091, s07-003, s07-019, s07-089, s07-143, s20-043*
- Mascaro, Lucia, *s02-041*
- Mascia, Michele, (*Mon s11*)17:20, *s10-069, s18-001, s18-028*
- Masiello, Fabio, (*Tue s01*)15:00
- Masilionis, Ignas, *s10-080*
- Masquelier, Christian, (*Thu 06*)17:00
- Massa, Andrea, *s11-029*
- Massaro, Giuseppe, (*Tue s13*)16:40
- Matabosch Coromina, Helena, *s08-018*
- Matanovic, Ivana, (*Tue s03*)15:20
- Matera, Sebastian, (*Tue s16*)15:40
- Matharu, Zimple, (*Mon s03*)14:40
- Mathe, Mkhulu K., (*Tue s08*)18:20
- Mathiesen, Nicolai, (*Mon s17*)18:20
- Mathwig, Klaus, (*Mon s01*)14:00, (*Wed s02*)09:30
- Matic, Aleksandar, *s08-010*
- Matsen, Leonard, (*Fri 20*)10:50, (*Fri 20*)11:10, *s10-049*
- Matsubara, Hiroshi, *s14-011*
- Matsubara, Kouki, *s06-113*
- Matsudaira, Masahki, (*Mon s01*)14:40
- Matsue, Tomokazu, (*Mon s01*)14:40, *s02-057*
- Matsumae, Kenji, *s12-003*
- Matsumiya, Masahiko, *s20-057*
- Matsumoto, Masashi, *s07-081*
- Matsushima, Hisayoshi, *s07-009*
- Matsuzawa, Koichi, (*Fri 07*)09:50, *s01-018, s07-081, s07-126, s07-136, s11-030, s12-003*
- Mattarozzi, Luca, (*Thu 10*)17:20, (*Thu 10*)17:40
- Mattelaer, Felix, *s06-082*
- Matyszewska, Dorota, (*Thu 04*)18:00, *s04-013*
- Maugé, D., *s03-051*
- Maximilian, Grandi, *s07-138*
- Maya-Cornejo, J., *s07-101*
- Maye, Sunny, (*Fri 07*)11:10
- Mayer, Matthew T., (*Fri 18*)11:10
- Mayo, Martin, *s06-125*
- Mayorova, Natalia, *s07-068, s15-005*
- Mayrhofer, Karl J.J., (*Mon s07*)17:00, (*Tue s07*)09:30, (*Thu 10*)14:20, (*Thu 07*)16:40, (*Thu 07*)18:00, (*Fri 20*)10:10, (*Fri 07*)11:30, *s07-022, s07-063, s07-082, s07-090, s07-111, s07-113, s10-004*
- Mazare, Anca, *s02-066, s06-054, s07-013, s10-009, s10-010, s10-063, s10-068, s18-033*
- Mazetyte, Airina, *s10-080*
- Mazur, Petr, *s07-037, s07-038, s07-041*
- Mazurenko, Ievgen, *s03-007*
- McCloskey, Bryan, (*Tue s01*)14:00
- McDougald, Diane, (*Mon s13*)18:20
- McGrath, Louise, *s06-057*
- McKeown, Neil B., *s02-011, s02-032, s02-077*
- McKerracher, Rachel, *s06-085, s06-126*
- Meas, Yunny, *s20-032*
- Mechler, Christoph, *s10-008*
- Medeiros de Araujo, Danyelle, (*Tue s11*)15:00, *s11-028*
- Medina, Danea, *s06-091*
- Meinen, Rieke, (*Tue s07*)18:20
- Meister, Paul, *s06-055*
- Mekonnen, Yedilfana, (*Mon s17*)18:20
- Melander, Marko, (*Mon s17*)18:20
- Melchionna, Michele, (*Fri 10*)10:10
- Melke, Julia, (*Wed s07*)09:30, (*Thu 07*)15:20, *s07-039*
- Mellahi, Dhaouadi, *s11-047*
- Melnikov, Alexey, *s16-019*
- Membreno, D., (*Tue s06*)14:20
- Mena, Vicente, (*Tue s13*)18:20
- Mendez-Morales, Trinidad, *s06-026*
- Mendil-Jakani, Hakima, (*Mon s06*)17:40
- Mendoza, Carlos, (*Tue s14*)18:20
- Mendoza, Maria Krisandra, *s07-001, s20-029*
- Mendoza-Hernandez, Omar S., *s06-049, s06-066, s11-054*
- Mendoza-Huizar, Luis Humberto, *s07-053*
- Meneghello, Marta, *s03-047*
- Menshchikov, Vladislav, *s07-057*
- Mentizi, Stamo, *s11-052*
- Mentré, Olivier, (*Thu 06*)17:00
- Merdon, Christian, *s09-018, s20-007*
- Merisalu, Maito, (*Fri 20*)11:10
- Merla, Yuri, (*Thu 12*)15:40
- Merrouch, Meriem, (*Thu 18*)14:40
- Merzdorf, Thomas, (*Mon s07*)09:30
- Mescheder, Ulrich, *s01-024*
- Metangmo, Armelle, *s01-014*
- Metelková, Radka, *s15-014*
- Metkemeijer, Rudolf, (*Tue s07*)09:50
- Meutzner, Falk, (*Fri 06*)11:50
- Meyer, Dirk C., (*Fri 06*)11:50
- Meynen, Vera, (*Thu 18*)17:00, *s10-100, s18-025*
- Meynial-Salles, Isabelle, (*Mon s03*)10:10
- Mezzavilla, Stefano, *s07-111*
- Michaelis, Alexander, (*Thu 10*)18:00, *s01-003*
- Michalak, Magdalena, (*Thu 02*)15:20
- Michalska, Joanna, *s13-004*
- Michaud, Pamela, (*Thu 20*)14:00
- Michez, Roman, *s18-014*
- Michler, Johann, (*Tue s14*)17:40, *s14-008*
- Miguel, Fernando, *s10-048*
- Mihali, Voichita, *s01-001*
- Mika, Krystyna, *s10-052*
- Milan, David, (*Thu 16*)10:10
- Milbrat, Alexander, *s18-039*
- Miller, John R., (*Tue s08*)09:30
- Milshtein, Jarrod, *s07-042*
- Milton, Ross, (*Tue s03*)09:50
- Milutinovic, Milena, (*Tue s03*)18:20
- Mimura, Hideyuki, (*Mon s06*)18:00

- Minami, Ryoji, (*Tue s06*)17:40
 Minamimoto, Hiro, (*Mon s15*)15:40, *s13-024, s16-042*
 Mingers, Andrea M., *s10-004*
 Minguzzi, Alessandro, (*Thu 10*)15:40, *s10-011, s16-014*
 Minhová Macounová, Katerina, *s11-053*
 Minter, Shelley, (*Tue s03*)09:50, *s03-001*
 Miranda-Castro, Rebeca, (*Mon s03*)15:40
 Miranda-Ordieres, Arturo J., (*Mon s03*)15:40
 Mirasoli, Mara, (*Fri 10*)11:50
 Mironenko, Alexander, *s06-063*
 Miroslavov, Veselin, (*Fri 07*)10:50
 Mirsky, Vladimir M., (*Fri 02*)10:50
 Mirzaei, Peyman, (*Thu 10*)14:40
 Miserque, Frederic, (*Tue s13*)14:40
 Mishra, Haritosh, (*Fri 13*)11:50
 Missoni, Leandro, (*Wed s09*)10:10
 Mistry, Hemma, (*Thu 18*)16:40, (*Thu 07*)18:20
 Mitraka, Evangelia, *s08-003*
 Mitrova, Biljana, *s03-048*
 Mitsushima, Shigenori, (*Fri 07*)09:50, *s07-081, s07-126, s07-136, s11-030, s12-003*
 Miyatake, Kenji, *s07-120*
 Miyazaki, Kohei, *s06-090*
 Mizaiakoff, Boris, (*Tue s01*)18:00
 Misin, Maksim, (*Tue s08*)17:20
 Mladenov, Mladen, *s08-039*
 Modestov, Alexander, *s07-028*
 Modin, Oskar, (*Thu 05*)10:30
 Möller, Sandra, *s07-019*
 Moeller, Timmey, (*Thu 18*)16:40
 Moguchikh, Yelizaveta, *s07-057*
 Mohajernia, Shiva, *s10-009, s10-010*
 Mohamedi, Mohamed, *s07-052*
 Mohd Zawawi, Ruzniza, *s10-095*
 Moitzheim, Sébastien, (*Wed s10*)10:10
 Moldovan, Simona, (*Tue s07*)17:40
 Molenaar, Sam, *s05-007*
 Molenda, Marcin, *s06-004*
 Molina, Angela, *s01-037*
 Molina Concha, Belen, (*Tue s07*)09:50
 Molina Osorio, Andrés, *s16-028*
 Molls, Christoph, (*Tue s06*)15:00
 Momiyama, Misayuki, *s03-025*
 Momma, Toshiyuki, (*Thu 06*)16:40
 Momotenko, Dmitry, (*Tue s03*)17:00, (*Fri 02*)11:50
 Monnin, Alexandra, (*Tue s14*)17:20
 Monroe, Charles, (*Mon s17*)10:30
 Monsalve, Karen, *s03-007*
 Montañés, María Teresa, *s10-073*
 Montemor, M. Fatima, (*Tue s13*)17:20, (*Wed s13*)09:30, *s08-025, s08-029*
 Montes de Oca, María Guadalupe, *s20-033*
 Montes, Isaac José Sánchez, *s20-048*
 Montes, Iziar Begoña, *s05-004*
 Monti, Gustavo, *s06-051*
 Montiel, Vicente, *s01-020*
 Montigny, Benedicte, *s06-103*
 Montini, Tiziano, *s10-022*
 Montoto, Elena, *s07-042*
 Monyoncho, Evans, *s16-001*
 Monzó, Javier, (*Thu 07*)14:20, (*Thu 10*)15:40, *s18-015*
 Moon, Sang-Hyun, *s10-064, s10-065*
 Moore, Jeffrey S., (*Thu 10*)15:40, *s07-042*
 Mooste, Marek, *s10-049*
 Moraes, Fernando C., (*Thu 20*)18:00, *s02-042*
 Morais, Claudia, *s07-139*
 Morais, Ruiter, *s01-021, s09-010, s20-053*
 Morais, Vitória, *s11-041*
 Moraleda, Inmaculada, *s20-040*
 Morales, E., *s07-102*
 Morales Hernandez, Dulce Maria, *s06-091, s07-143*
 Morales-Acosta, Diana, *s07-115, s07-121*
 Morallón, Emilia, *s01-040, s01-041, s10-053*
 Morandi, Sara, (*Thu 10*)15:40, *s10-011, s16-014*
 Morante, Joan Ramon, (*Fri 18*)09:30, (*Fri 18*)10:10, (*Fri 07*)11:50, *s11-039*
 Morawietz, Tobias, (*Mon s07*)14:40
 Moreau, Philippe, (*Thu 06*)15:40
 Moretto, Ligia Maria, *s01-016*
 Mori, Shogo, (*Thu 18*)17:20
 Mori, Takuya, (*Fri 06*)11:50
 Morimoto, Yu, (*Mon s17*)15:00
 Morita, Hiroshi, *s07-103*
 Morita, Masayuki, (*Mon s06*)18:00
 Morita, Naoto, (*Fri 07*)09:50, *s11-030*
 Morris, Andrew, *s06-125*
 Mosa, Jadra, (*Mon s13*)17:20, *s06-050, s07-102, s13-001*
 Moscoso, Raúl, *s10-101*
 Moshtarikhah, S., (*Mon s11*)09:50
 Mostany, Jorge, *s20-033, s20-062*
 Motobayashi, Kenta, (*Tue s16*)14:40, *s16-033, s18-017*
 Motoyama, Daisuke, *s15-023*
 Moya, Antonio Angel, *s08-037, s11-007*
 Mrlik, Jindrich, *s07-037*
 Mubita, Tania, *s09-006*
 Müller, Andre, *s06-047*
 Müller, Claus, *s16-027*
 Müller, Frank, *s03-005*
 Mueller, Ruediger, *s09-021, s17-010*
 Mugikura, Yoshihiro, *s07-103*
 Muhammad, Hamida, (*Tue s15*)09:30
 Muhler, Martin, (*Thu 07*)18:20, *s07-089*
 Muhs, Anna, *s01-017*
 Mujtaba, Ayesha, *s02-008*
 Mukoyama, Daikichi, (*Thu 06*)16:40
 Mukra, Tzah, (*Tue s06*)14:00
 Mul, Guido, *s18-039*
 Mulas, Andrea, *s15-015*
 Mulder, Fokko M., *s06-107*
 Muller-Bouvet, Diane, (*Fri 06*)11:10
 Mundhenk, Jennifer, *s03-024*
 Munguía-Galván, Silvia-Viridiana-Aideé, *s09-014*
 Muñoz, Eduardo, *s03-034, s10-050, s10-097*
 Muñoz, Josemari, (*Tue s14*)18:00
 Muñoz, Martin, (*Tue s11*)10:30
 Muñoz, Valentina, *s01-032*
 Muñoz-Portero, Maria Jose, *s10-074*
 Murakoshi, Kei, (*Mon s15*)15:40, (*Tue s16*)18:20, *s13-024, s16-042*
 Murashko, Kirill, *s10-039*
 Murata, Yoshiaki, (*Tue s06*)17:40
 Murawska, Magdalena, (*Wed s03*)10:10
 Murcia-López, Sebastián, (*Fri 18*)09:30
 Murcia-Hernández, Saacnhitee, *s09-014*
 Musgrove, Amanda, (*Mon s16*)09:30, *s03-028*
 Musiani, Marco, (*Thu 10*)17:20, (*Thu 10*)17:40
 Mussini, Patrizia, (*Mon s01*)15:40, *s01-001*
 Muto, Marika, *s07-086*
 Mutschke, Gerd, *s07-018*
 Muya, Francis Ntumba, *s01-038*
 Myalo, Zolani, *s06-025*
 Mysyk, Roman, (*Mon s08*)17:40
- ## N
- Nadappuram, Binoy Paulose, (*Tue s03*)17:00
 Nagai, Takaaki, *s07-081, s07-126, s07-136*
 Nagasawa, Kensaku, (*Fri 07*)09:50, *s01-018, s11-030, s12-003*
 Naggar, Ahmed, *s07-106*
 Nagle, Lorraine, (*Fri 02*)10:10
 Nagumo, Yuzo, *s07-083*
 Naimi, Mohamed, *s10-079*
 Nakagawa, Rie, (*Fri 13*)11:30
 Nakai, Yuta, *s07-104*
 Nakamura, Masashi, (*Tue s16*)18:00
 Nakamura, Ryuhei, (*Thu 18*)17:20, *s15-027*
 Nakamura, Takuya, *s03-023*
 Nakata, Kazuya, *s03-063*
 Nakatsuyama, Kunio, (*Tue s13*)18:00
 Naldoni, Alberto, *s10-011, s16-014*
 Nan, Zi-Ang, *s15-031*
 Nandhakumar, Ponnusamy, *s01-009*
 Naoi, Katsuhiko, (*Mon s08*)09:30, (*Tue s08*)14:20
 Naoi, Wako, (*Mon s08*)09:30
 Napporn, Teko, *s01-018, s07-065, s07-139, s16-021*
 Nara, Hiroki, (*Thu 06*)16:40
 Narischat, Napan, *s02-015*
 Nasir, Tauqir, *s02-033*
 Nassi, Achille, *s03-051*
 Nassr, Abu Bakr, *s07-105, s07-106*
 Natale, Paolo, (*Mon s03*)10:30
 Naumov, Olga, *s07-097*
 Naumowicz, Monika, *s03-030, s03-032*
 Nava, José L., (*Mon s11*)15:40, (*Tue s11*)15:40, *s07-036, s11-009, s11-016, s11-035*
 Navarrete, Emilio, *s03-034, s10-050, s10-097*
 Navarro, Vicente, *s11-008*
 Navikas, Vytautas, *s10-080*
 Navratil, Rudolf, *s01-049*
 Navratil, Tomas, (*Mon s03*)17:20
 Nayak, Simantini, *s17-001*
 Nazar, Linda F., (*Tue s21*)08:15
 Nazaruk, Ewa, (*Thu 04*)18:00
 Ndipingwi, Miranda, *s06-025*
 Nefedov, Alexei, *s07-039*
 Negrila, Catalin, *s20-015*
 Nekrasov, Alexander, (*Thu 10*)16:00, *s10-033*
 Nelayah, Jaysen, (*Tue s07*)17:40
 Németh, Katalin, *s16-027*
 Nénert, Gwilherm, (*Tue s01*)15:00
 Neofytidis, Charalampos, *s07-108*
 Neophytides, Stylianos, *s07-107, s07-108*
 Nestler, Tina, (*Fri 06*)11:50

- Neto, Jeronimo, *s01-053*
 Netto, Chaquip D., (*Tue s15*)10:30
 Neumann, Bettina, *s03-013, s03-049*
 Neumann, Burt, *s13-005*
 Nevstrueva, Daria, *s10-039*
 Ngila, Jane, *s11-055*
 Nguyen Cong, Phuc, *s01-031*
 Nguyen, Nhat Truong, *s06-054, s07-013, s18-033*
 Nguyen, Tuyen, *s08-029*
 Ni, Chung-Ta, *s07-095, s07-096*
 Nia, Pooria Moozarm, *s02-052*
 Niakolas, Dimitris, *s07-108*
 Niaura, Gediminas, *s10-086*
 Nichols, Richard, (*Thu 16*)10:10
 Nie, Ji, (*Mon s03*)17:40
 Niederberger, Markus, (*Mon s07*)18:00, (*Tue s14*)17:40
 Nierop y Sancheza, Chris, (*Mon s16*)15:40
 Niewiadomy, Andrzej, *s03-057, s04-017*
 Niilisk, Ahti, (*Fri 20*)11:10
 Niiyama, Ayumu, (*Tue s03*)16:00
 Nilsson, Anders, (*Wed s21*)08:15
 Nimmo, Tammy, *s16-047*
 Nishida, Kosuke, *s03-023*
 Nishihata, Keiichi, *s20-057*
 Nishiki, Yoshinori, (*Fri 07*)09:50, *s11-030, s12-003*
 Nithyadharseni, P., (*Tue s08*)18:20
 Nitta, Naoki, (*Mon s06*)16:00
 Nitze, Florian, *s08-010*
 Niu, Ben, *s20-037, s20-038*
 Niu, Yubiao, *s10-003*
 Niwa, Osamu, *s01-046*
 Nizamov, Shavkat, (*Fri 02*)10:50
 Nizhnikovskiy, Eugene, *s07-068*
 Nkosi, Duduzile, *s02-079*
 Nkosi, Funeka P., (*Tue s08*)18:20
 Noack, Jens, (*Wed s07*)10:10
 Nobili, Francesco, *s06-048*
 Nóbrega, Gabriela, *s01-021*
 Noël, Jean-Marc, (*Mon s15*)10:10
 Noel, Nanni, (*Mon s13*)10:10
 Noël, Vincent, (*Mon s01*)17:20
 Nöll, Gilbert, (*Mon s01*)17:40, *s03-042*
 Nogala, Wojciech, (*Thu 02*)15:20, (*Thu 20*)16:00
 Noguchi, Hidenori, (*Mon s16*)18:20
 Noh, Hyun Kuk, *s06-029*
 Noh, Seunghyo, *s07-077*
 Noh, Soodong, *s01-009*
 Nohara, Saki, *s03-025*
 Nokbin, Somkiat, (*Mon s01*)15:20
 Nordmann, Daniela, (*Tue s11*)17:20
 Nore, Caroline, *s06-129*
 Norel, Lucie, *s15-015*
 Noto, Renato, *s15-002*
 Notten, P.H.L., *s06-109*
 Novák, Libor, *s06-032*
 Novák, Petr, (*Mon s06*)09:50, (*Tue s08*)10:30, (*Tue s06*)18:00, (*Thu 06*)10:10, *s16-022*
 Novikov, Dmitriy, *s06-015*
 Novikova, Svetlana, *s06-096*
 Nowaczyk, Marc M., (*Tue s03*)10:10
 Nowak, Andrzej, *s06-017*
 Nowicki, Piotr, *s06-128*
 Noworyta, Krzysztof, (*Mon s03*)17:00
 Ntais, Spyridon, *s16-001*
 Ntumba-Ngoy, Christian, (*Tue s14*)14:00
 Nuttall, Philippa, (*Thu 02*)16:40
 Nxusani, Ezo, (*Thu 02*)10:30
 Nyholm, Leif, (*Wed s03*)10:30, *s06-006, s06-024, s06-072, s08-022*
 Nørskov, Jens. K., (*Tue s16*)15:00
- O**
 O'Conghaile, Peter, (*Tue s03*)15:00, (*Wed s03*)10:00, (*Thu 18*)15:40
 O'Neill, Laura, (*Fri 06*)10:50
 O'Sullivan, Shane, (*Thu 04*)15:00
 Obbade, Said, (*Mon s06*)18:20
 Oberhofer, Harald, (*Tue s16*)15:40, *s16-054*
 Ochs, Hartmut, (*Mon s13*)17:40
 Ocon, Joey D., (*Mon s07*)15:40
 Odijk, Mathieu, (*Mon s01*)18:00, *s02-056*
 Odobel, Fabrice, (*Thu 06*)15:40
 Oellers, T., (*Mon s01*)15:00
 Oezaslan, Mehtap, (*Tue s07*)18:20, *s10-005*
 Offer, Gregory, (*Thu 12*)15:40, (*Fri 06*)10:50
 Ogasawa, Toru, (*Fri 13*)11:30
 Ogasawara, Masaru, *s20-054*
 Ogawa, Satoshi, (*Fri 07*)10:50
 Ogle, Kevin, (*Tue s13*)14:40
 Ogunlesi, Modupe, *s04-019*
 Oh, In-Ae, *s06-021*
 Oh, Jung Min, *s20-028*
 Ohara, Koji, (*Fri 06*)11:50
 Ohl, Denis, *s02-002*
 Ohmer, Nils, (*Mon s06*)17:20
 Ohno, Takashi, *s07-083*
 Ohnuki, Atsuyori, *s13-024*
 Ohs, Burkhard, *s09-007*
 Ohta, Koji, *s06-077*
 Oikawa, Shunpei, *s13-024*
 Oka, Shota, *s02-043*
 Okamoto, Tatsuki, (*Tue s13*)10:10
 Okie, Wesley, *s04-019*
 Okur, Faruk, *s06-092*
 Oldani, Fabio, *s07-043*
 Oleinick, Alexander, (*Tue s03*)17:20, *s20-012*
 Olejnik, Piotr, (*Thu 20*)18:20
 Oliva, Fabiana, *s06-042, s06-051*
 Oliveira, Grasielli, *s01-048*
 Oliveira, Regina V., (*Tue s11*)14:00
 Oliveira, Thiago, *s02-055*
 Oliveira, Valéria, *s01-021*
 Oliveira-Brett, Ana Maria, (*Thu 04*)16:00, *s04-018*
 Oll, Ove, *s16-026, s16-041*
 Olloqui Sariego, Jose Luis, *s03-008, s03-041*
 Olmos, José Manuel, *s01-037*
 Olschewski, Mark, *s06-037*
 Olthuis, Wouter, (*Mon s01*)18:00
 Omar, Noshin, *s06-078*
 Omoda, Ryo, (*Thu 06*)09:50
 Omorebi, Ayokunle, (*Tue s09*)17:20
 Onderwaater, Willem G., *s16-010*
 Ono, Yasushi, *s20-057*
 Onofre-Bustamante, Edgar, *s13-002, s13-012*
 Ooka, Hideshi, *s18-016*
 Opallo, Marcin, (*Thu 02*)15:20, (*Thu 20*)16:00, *s02-047, s03-038*
 Opletal, Tomas, *s01-049*
 Oraá, Beatriz, (*Fri 07*)10:50
 Orain, Christophe, (*Mon s03*)10:10
 Orchard, Katherine, (*Tue s03*)09:30
 Orfino, Francesco P., (*Thu 07*)15:00
 Orfino, Frank, *s12-004*
 Oriani, Andrea, *s10-046*
 Orikasa, Yuki, (*Fri 06*)11:50
 Orłowska, Justyna, *s10-012*
 Ornano, Luigi, *s15-002, s15-003*
 Ortega, Emma M., *s11-004, s11-034*
 Orts, José M., *s16-002*
 Osada, Mitsumasa, *s07-071*
 Osaka, Tetsuya, (*Thu 06*)16:40
 Osawa, Masatoshi, (*Tue s16*)14:40, *s16-033, s18-017*
 Osawa, Motoaki, *s13-015*
 Oseland, Elizabeth, (*Tue s14*)15:40
 Osete-Cortina, Laura, *s20-009*
 Oshchepkov, Alexandr, *s07-144*
 Oshida, Noriyuki, (*Tue s06*)17:40
 Osiceanu, Petre, *s13-013*
 Osorio, Henry, (*Thu 16*)10:10
 Osorio-Mina, Lizeth, *s11-010*
 Oszczapowicz, Irena, *s03-058*
 Oszczapowicz, Janusz, *s03-058*
 Ota, Ken-ichiro, *s07-081, s07-126, s07-136*
 Otani, Minoru, (*Mon s17*)14:20
 Otero, Manuel, *s06-041, s06-042, s06-051, s06-052*
 Otmacic Curkovic, Helena, (*Mon s13*)15:20, *s13-020, s13-026*
 Oturan, Mehmet A., (*Tue s11*)16:40, *s09-012*
 Oturan, Nihal, (*Tue s11*)16:40
 Ou, Li Wei, (*Fri 13*)10:10
 Oughli, Alaa, (*Tue s03*)14:40
 Oulmas, Cylia, *s13-021, s13-027*
 Oulmi, Kafia, *s11-047*
 Oumellal, Yassine, *s10-056*
 Ourari, Ali, *s10-053*
 Oviedo, Oscar, *s06-042*
 Owen, John, (*Fri 06*)09:30, *s06-116*
 Ozanam, François, (*Thu 06*)14:40
 Ozawa, Hiroaki, (*Fri 10*)11:30, *s02-043, s15-023*
 Ozcan, Ali, *s10-098, s20-049, s20-055*
 Ozcan, Seyma, *s06-002, s06-053*
 Ozen, Umit Ergin, *s10-099*
 Ozga, Piotr, (*Mon s13*)14:00
 Ozimek, Weronika, *s02-009*
 Ozkan, Selda, *s06-054, s10-068*
 Ozkaya, Ali Riza, *s10-013, s10-099*
 Ozoemena, Kenneth I., (*Tue s08*)18:20, *s06-025*
 Oztürk, Efe Deniz, *s20-016*
- P**
 Pacheco, Cassiano, *s09-010*
 Packer, Michael A., (*Thu 18*)15:40
 Paez, Maritza, *s13-022*
 Page, Ashley, (*Fri 02*)11:50, *s03-031*
 Paidar, Martin, (*Mon s11*)14:00, (*Mon s11*)14:40, (*Tue s11*)10:10, *s11-031*
 Paik, Jun Hwan, *s07-109*
 Pailleret, Alain, *s03-016*
 Paiva, Wylley, *s02-055*
 Paixão, Thiago, *s20-002, s20-010, s20-011*

- Pajkossy, Tamás, *s08-038, s16-027*
 Palacios-Gonzalez, E., *s07-128*
 Palanisamy, Kannan, *s02-007*
 Palermo, Vincenzo, *(Thu 04)14:40*
 Palestino, Gabriela, *s10-096*
 Palinska-Saadi, Adriana, *s03-058*
 Palko, James, *(Tue s09)09:30*
 Palkovits, Regina, *s07-006*
 Palkovits, Stefan, *s07-006*
 Palma, Jesús, *(Tue s08)18:00, (Thu 09)09:50, (Fri 07)10:50*
 Palma-Cando, Alex, *s10-034*
 Palmas, Simonetta, *s18-001, s18-028*
 Palmer, Richard E., *s10-003*
 Palmieri, Alessandro, *s06-048*
 Palomar-Pardavé, Manuel, *s01-022, s20-033, s20-062*
 Paloukis, Fotis, *s07-107*
 Palys, Barbara, *(Thu 20)18:20*
 Pampel, Jonas, *s10-015*
 Pan, Chen, *(Tue s13)15:00*
 Pan, Chen-Fu, *s10-082*
 Pan, Likun, *(Tue s09)10:30*
 Panagoulia, Danai, *s16-047*
 Pankratov, Dmitry, *s03-015, s03-017*
 Pankratova, Galina, *(Wed s03)10:40, (Thu 18)15:40*
 Panne, Ulrich, *s20-047*
 Pant, Deepak, *(Thu 18)15:00, s18-027*
 Panteix, Pierre-Jean, *(Tue s11)14:20*
 Paolucci, Francesco, *(Thu 04)14:40, (Thu 04)18:20, (Fri 10)10:10, (Fri 10)11:50, s10-022, s15-030, s15-037*
 Papaderakis, Athanasios, *s10-014*
 Papara, Nicoleta, *s02-023*
 Papastavrou, Georg, *(Tue s01)18:20*
 Papirio, Stefano, *(Tue s11)16:40*
 Parak, Wolfgang J., *(Tue s08)18:00*
 Paris, Oskar, *(Tue s08)15:40*
 Park, Byeong June, *s20-020*
 Park, Chanbum, *s06-127*
 Park, Eunjun, *s06-033*
 Park, Hyan Joo, *s07-016*
 Park, Hyun-Suk, *s10-062*
 Park, Jin-Young, *s10-062*
 Park, Jong Hwan, *s06-105*
 Park, Kyung-Won, *s10-062*
 Park, Mihui, *s06-093*
 Park, Seonhwa, *s01-010, s01-011*
 Park, Sung Hyeon, *(Tue s08)17:00*
 Park, Sung June, *s12-008*
 Parkinson, Dilworth Y., *(Thu 07)14:00*
 Parmon, Valentin, *s07-144*
 Parra, Andrés, *(Fri 18)09:30*
 Parviz, Maryam, *s04-002*
 Passerini, Stefano, *(Mon s06)15:20, (Tue s06)17:20, (Thu 06)09:50, s06-069, s06-080, s06-097, s06-112*
 Pastor, Elena, *s07-114*
 Patel, Manu U.M., *(Mon s06)17:00*
 Patella, Bernardo, *(Fri 10)10:50*
 Patil, Bhushan, *s06-094*
 Patil, Sunil, *s05-011*
 Patolsky, Fernando, *(Mon s06)16:40*
 Patroniak, Violetta, *s15-024*
 Patzauer, Maximilian, *(Tue s16)10:30*
 Pauchet, Joël, *(Thu 07)15:00*
 Pauliukaite, Rasa, *s10-080, s10-086*
 Pauwels, Danny, *(Thu 18)17:00, s11-032*
 Pawlik, Anna, *(Fri 10)09:50, s10-081*
 Payen, Christophe, *(Tue s08)14:20*
 Pečar Ilič, Jadranka, *s03-029*
 Peak, Derek, *(Thu 07)16:40*
 Pebere, Nadine, *(Wed s13)09:50, s13-014*
 Pechaud, Yoan, *(Tue s11)16:40*
 Pecoraro, Claudio Maria, *s07-117*
 Pedersen, Emil B., *s18-010*
 Pedersen, Steen U., *s18-010*
 Pekmez, Kadir, *s09-022*
 Peled, Emanuel, *(Mon s06)16:40, (Tue s06)14:00, s06-003*
 Peleyeju, Gbenga, *s11-033*
 Peleyeju, Moses, *s11-055*
 Pelicci, Pier Giuseppe, *(Thu 04)14:40*
 Peljo, Pekka, *(Thu 20)09:30, (Fri 07)09:30, (Fri 07)11:10, s07-032, s15-035, s17-003*
 Pellegrin, Yann, *(Thu 06)15:40*
 Penelas, Germán, *(Fri 18)09:30*
 Peng, Fei, *s06-014*
 Peng, Hsiao-Shan, *s14-001*
 Peng, Qiling, *(Tue s16)14:40*
 Penicaud, Alain, *(Fri 10)11:50, s15-030*
 Penoni, Andrea, *(Mon s01)15:40*
 Pensa, Eva, *s07-076*
 Pensa, Evangelina, *(Tue s16)10:10*
 Perassi, Eduardo, *s06-042*
 Perazzolo, Valentina, *(Thu 07)18:20, s07-074, s07-110*
 Pereira da Silva Neves, Marta Maria, *s03-043*
 Pereira Da Silva, Rejane Maria, *s01-039*
 Pereira, Ernesto C., *(Thu 20)18:00, s02-041, s10-001*
 Pereira, Gabriel F., *(Tue s11)14:00*
 Pereira, Ines A.C., *(Mon s03)10:30*
 Pereira-Ramos, Jean-Pierre, *(Fri 06)11:10*
 Perera, Marian, *(Tue s14)16:00, s20-051*
 Perez Gallent, Elena, *s18-023*
 Perez Jimenez, Ana Isabel, *s01-013*
 Pérez, José Fernando, *s11-042*
 Pérez Junquera, Alejandro, *s03-043*
 Pérez, Rosalina, *(Tue s14)18:00*
 Pérez, Tzayam, *(Tue s11)15:40*
 Pérez-Alonso, Francisco José, *(Fri 06)11:30, s20-032*
 Pérez-Herranz, Valentín, *s11-004, s11-034*
 Pérez-Segura, Tzayam, *s09-014*
 Pérez-Velázquez, Daniela, *s11-014*
 Permentier, Hjalmar, *(Mon s01)18:00, s15-006*
 Perrot, Hubert, *s03-016*
 Perruchot, Christian, *(Thu 10)17:40*
 Perry, David, *(Tue s03)17:00, (Fri 02)11:50, s03-031*
 Perry, Samuel C., *(Mon s16)17:20*
 Persson, Ingmar, *s06-014*
 Persson, K., *(Tue s06)14:20*
 Peticarari, Sofia, *(Thu 06)15:40*
 Pescarmona, Paolo, *(Thu 07)17:40*
 Peshkova, Anna, *s06-015*
 Petek, Ursa, *s10-015*
 Petelska, Aneta, *s03-030, s03-032*
 Peters, Fabian, *s06-074*
 Petitjean, Carine, *(Tue s11)14:20*
 Pfaffeneder-Kmen, Martin, *s10-035*
 Pfenninger, Reto, *(Mon s06)10:30*
 Pfisterer, Jonas, *(Thu 06)17:40*
 Pfrang, Andreas, *(Thu 12)15:20, s06-058*
 Phelane, Lisebo, *(Thu 02)15:40*
 Philippe, Laetitia, *(Tue s14)17:40, s14-008*
 Phuan, Yi Wen, *(Tue s14)15:20*
 Piazza, Salvatore, *(Fri 10)10:50, s04-020, s07-010, s07-011*
 Picard, Lionel, *(Mon s06)17:40*
 Picco, Agustin Silvio, *s16-008*
 Picelli, Luca, *s07-074*
 Pichler, Birgit, *s07-040*
 Pickard, Chris, *s06-125*
 Pjerozynski, Boguslaw, *s07-020*
 Pietrzak, Robert, *s06-128*
 Pignolet, Céline, *(Tue s14)17:20*
 Piili, Heidi, *(Thu 07)14:00*
 Pikma, Piret, *s16-026*
 Pilot, Roberto, *s07-074*
 Pingarrón, José M., *(Thu 04)14:00*
 Pinkwart, Karsten, *(Wed s07)10:10*
 Pino, Mikel, *(Fri 06)11:30*
 Pinson, Jean, *(Thu 10)18:00*
 Pintelon, Rik, *(Mon s01)10:10*
 Pinyou, Piyanut, *s03-015*
 Piquero Cilla, Joan, *s20-008*
 Pires de Paiva Barreto, Jessica, *s11-028*
 Pirnat, Klemen, *(Tue s06)15:20*
 Piro, Benoît, *(Mon s01)17:20*
 Pirri, Candido F., *(Mon s08)16:00, s11-029, s16-049, s18-004*
 Pisarek, Marcin, *s16-005*
 Pita, Marcos, *(Mon s03)10:30, s03-003, s03-017*
 Pizzutilo, Enrico, *(Thu 07)18:00, s07-113*
 Placke, Tobias, *s06-055, s06-056, s06-118*
 Plazanic, Marko, *(Mon s13)15:20*
 Pleskov, Yuri, *(Fri 21)08:15*
 Plesse, Cedric, *s10-102*
 Pletcher, Derek, *(Thu 07)17:00*
 Pletikapić, Galja, *s03-029*
 Plumeré, Nicolas, *(Mon s01)15:00, (Tue s03)14:40, (Thu 18)14:40, (Thu 10)17:00, s03-005, s03-050, s17-006*
 Pocedic, Jaromir, *s07-037, s07-038, s07-041*
 Podesva, Pavel, *s02-025*
 Podvorica, Fetah I., *(Thu 10)18:00*
 Pölt, Peter, *s16-032*
 Poirot-Crouvezier, Jean-Philippe, *(Mon s07)14:00*
 Poizot, Philippe, *(Mon s08)10:10, (Thu 06)15:40*
 Pokhrel, Anish, *s12-004*
 Pokpas, Keagan, *s01-047*
 Pokrant, Simone, *(Thu 20)17:40, s10-058*
 Polonsky, Jakub, *(Tue s11)10:10*
 Poloznikov, Andrey A., *s03-008*
 Polrolniczak, Paulina, *s06-128, s08-011*
 Poltorak, Lukasz, *(Tue s01)09:50, s03-033*
 Polymeros, George, *(Tue s07)09:30, (Thu 07)16:40, (Thu 07)18:00, (Fri 07)11:30, s07-082, s07-111*
 Ponce de Leon, Carlos, *s06-085, s20-058*
 Ponce-Varela, María G., *s07-128*
 Ponomarev, Igor, *s07-068*
 Pons, Marie-Noëlle, *(Mon s11)15:20*
 Ponzio, Eduardo, *(Wed s13)10:10, s01-048*

- Popa, Monica, *s13-013*
 Pope, Cameron, *s06-083*
 Popov, Alexey, *s15-042*
 Porada, Slawomir, *s09-006*
 Portehault, David, *s07-139*
 Posdorfer, Joerg, (*Fri 13*)11:50
 Pototskaya, Valentina, *s17-007*
 Poulsen, Morten Gildsig, *s10-016, s10-036*
 Poyatos Salguero, Noemí, *s07-129*
 Pozo, Guillermo, *s05-008*
 Pozuelo, Marta, (*Wed s03*)09:50
 Prathish, Krishna, (*Thu 10*)14:20
 Prato, Maurizio, (*Fri 10*)10:10, *s10-022*
 Pratt, Keith, *s10-093*
 Prehal, Christian, (*Tue s08*)15:40
 Presser, Volker, (*Mon s08*)15:00,
 (*Tue s08*)15:20, (*Tue s08*)15:40,
 (*Tue s09*)16:40, *s08-033*
 Preuss, Kathrin, *s07-098*
 Previdello, Bruno A.F., *s20-046*
 PrévotEAU, Antonin, (*Wed s05*)10:30
 Prezhdo, Oleg, *s18-012*
 Prieto, Francisco, (*Wed s03*)10:20,
s16-048
 Prill, Torben, (*Thu 12*)18:00
 Prodanovic, Predrag, (*Mon s13*)15:20
 Prodi, Luca, *s15-037*
 Proietto, Federica, (*Mon s11*)17:00
 Prokop, Martin, (*Mon s11*)14:40, *s12-010*,
s20-059
 Proust, Anna, *s18-002*
 Prugovecki, Stjepan, (*Tue s01*)15:00
 Pryadchenko, Vasilii, *s07-056*
 Przygocki, Patryk, *s08-006*
 Przygodda, Dennis, *s07-044*
 Puga, Beatriz, *s13-011*
 Pumera, Martin, *s02-050*
 Pupo, Marilia, *s09-015*
 Purdy, Geraldine M., (*Tue s07*)14:20
 Puthiyapura, Vinod Kumar, *s07-105*,
s07-112
 Pyka, Philipp, *s07-047*
 Pyrhönen, Juha, *s10-039*
- Q**
 Qi, Jianqing, (*Mon s03*)14:40
 Qi, Liming, *s04-012*
 Qi, Wenjing, *s04-012*
 Qi, Yunchuan, (*Fri 06*)09:50
 Qian, Pengfei, *s08-019*
 Qian, Shaoyi, *s07-042*
 Qiao, Yu, *s16-040*
 Qin, Zongyi, *s08-014, s08-015, s08-019*
 Qu, Baihua, (*Fri 06*)09:50
 Qu, Xi-Ming, *s10-006*
 Qu, Yatian, (*Tue s09*)09:30
 Quaino, Paola, *s16-052*
 Quarez, Eric, (*Thu 06*)15:40
 Quell, Thomas, *s11-052*
 Quéniat, Gurvan, (*Fri 02*)09:30
 Quezada, Diego, *s18-011*
 Quinta-Ferreira, Rosa M., *s11-019*,
s11-020
 Quiroz, Marco Antonio, *s16-037*
 Qvortrup, Katrine, *s03-012*
- R**
 Raaijman, Stefan, (*Mon s07*)17:40
 Rabaey, Korneel, (*Wed s05*)10:30,
 (*Thu 05*)10:10, *s05-011*
 Rabanca, Andreea, *s04-003*
 Rabe, Martin, *s07-021*
 Rachuri, Venkata Jagadeesh, *s02-071*
 Raciukaitis, Gediminas, *s10-086*
 Raczkowska, Adrianna, *s03-009*
 Raddiar, Mahima, (*Fri 13*)11:50
 Radu, Valentin, (*Tue s03*)09:30
 Radzevic, Aneta, *s10-086*
 Raël, Stéphane, (*Thu 12*)16:00
 Rahemi, Vanoushe, *s10-100*
 Raicheff, Raicho, *s08-039*
 Rajamani, Sunita, *s15-011*
 Raju, Kumar, (*Tue s08*)18:20
 Ramani, Vijay K., *s07-059*
 Ramarli, Dunia, *s15-037*
 Ramasamy, Parthiban, *s08-013*
 Ramasamy, Ramaraja, (*Wed s05*)10:50
 Ramezani Karimi, Raziye, *s02-058*
 Ramírez-Álvarez, Elizabeth, (*Mon s13*)09:30
 Ramírez-Meneses, Esther, *s07-128*
 Ramirez-Silva, Maria Teresa, *s01-022*,
s09-013, s20-062
 Ramos, Carlos, (*Wed s13*)10:10
 Rampazzo, Enrico, *s15-037*
 Randall, Phillipa, *s04-011*
 Randon-Vitanova, Anna, (*Tue s06*)15:20
 Ranjan, Chinmoy, (*Mon s07*)09:50
 Rannou, Patrice, (*Mon s06*)17:40
 Raphaël, Chattot, (*Tue s07*)17:40
 Rapin, Christophe, (*Tue s11*)14:20
 Rapino, Stefania, (*Thu 04*)14:40,
 (*Thu 04*)18:20, (*Fri 10*)10:10
 Rapta, Peter, *s15-041*
 Rassaei, Liza, (*Mon s01*)14:00
 Rassie, Candice, *s04-008, s04-011*
 Rastgar, Shokoufeh, (*Thu 10*)18:20
 Rathakrishnan, Sivaprakasam, *s07-026*
 Ratner, Noga, (*Thu 02*)14:40
 Ratso, Sander, (*Thu 07*)15:20
 Rauwel, Protima, (*Thu 07*)15:20,
 (*Fri 20*)10:50, (*Fri 20*)11:10
 Ravaine, S., (*Wed s03*)10:10
 Ravnsbæk, Dorthe, *s06-012*
 Rawlence, Michael, (*Mon s06*)10:30
 Rayée, Quentin, *s14-012*
 Raymakers, Leonard, (*Thu 12*)17:40
 Razal, Joselito M., (*Tue s08*)17:40
 Razzino, Claudia, *s02-027*
 Recio, F. Javier, *s10-017*
 Reculosa, Stéphane, (*Wed s03*)10:10,
 (*Thu 10*)10:10
 Reda, Mateusz, (*Mon s17*)15:40
 Redondo, Edurne, (*Mon s08*)17:40
 Redondo Marugán, Jorge, *s20-009*
 Rees, Neil, *s10-003*
 Regier, Tom Z., (*Thu 07*)16:40
 Reguero, Victor, (*Tue s08*)18:00,
 (*Thu 09*)09:50
 Reier, Tobias, (*Mon s07*)10:10
 Reimers, Jeffrey R., (*Mon s03*)09:30
 Reinsberg, Philip, (*Mon s06*)15:40,
 (*Fri 06*)10:50, *s20-007*
 Reisberg, Steeve, (*Mon s01*)17:20
 Reisner, Erwin, (*Tue s03*)09:30
 Ren, Bin, *s16-045, s16-046*
 Ren, Dan, (*Thu 18*)17:40
 Renault, Christophe, (*Thu 02*)10:10
 Rendón-Enríquez, Ibeth, *s20-056*
 Rennie, Anthony, (*Mon s08*)16:40, *s08-005*
 Rensmo, Håkan, (*Thu 16*)09:50
 Retoux, Richard, (*Tue s08*)14:20
 Retsch, Markus, (*Tue s01*)18:20
 Reuter, Karsten, (*Tue s16*)15:40, *s16-054*,
s17-009
 Reyes Jiménez, Antonia, *s06-056*
 Rezende, Kênnia, *s20-053*
 Ribeiro, Francisco, *s16-018*
 Ricardo, Venegas, *s10-017*
 Rice, Scott A., (*Mon s13*)18:20
 Richter-Landsberg, Christiane, *s04-026*
 Riedel, Marc, (*Tue s03*)18:00, *s03-024*
 Rigaut, Stéphane, *s15-015*
 Ringe, Stefan, (*Tue s16*)15:40
 Rinklin, Philipp, (*Tue s03*)16:40
 Risch, Marcel, (*Thu 10*)15:20,
 (*Thu 07*)16:40
 Risco, Carolina, *s11-008*
 Risse, Sebastian, *s06-114*
 Rivas, Gustavo A., *s02-001*
 Rives, Bertrand, *s13-014*
 Rivolo, Paola, (*Mon s08*)16:00
 Rizzi, Gian Andrea, *s07-110*
 Rizzo, Simona, *s01-001*
 Roa-Morales, Gabriela, *s09-013*
 Robert, Marc, *s18-010*
 Robert, Rosa, (*Mon s06*)09:50, *s16-022*
 Roberts, Edward, (*Tue s11*)09:30
 Robin, Raphael, (*Tue s13*)09:30
 Robledo, Carla, *s06-052*
 Roca-Ayats, Maria, *s07-113, s07-114*
 Rocha, Anderson, (*Wed s13*)10:10
 Rocha Aveiro, Luci, *s02-044*
 Rocha, Thairo, (*Fri 07*)11:10
 Rocha-Filho, Romeu C., (*Tue s11*)14:00,
s01-025, s20-003, s20-050
 Roche, Jérôme, (*Thu 10*)10:10
 Roda, Aldo, (*Fri 10*)11:50
 Rodes, Antonio, (*Mon s16*)14:00, *s16-002*
 Rodner, Marius, (*Mon s08*)15:00
 Rodrigo, Manuel Andres, (*Tue s11*)10:30,
 (*Tue s11*)16:00, (*Tue s11*)17:00,
s05-003, s05-004, s11-008, s11-038,
s11-042, s20-040
 Rodriguez, G., (*Mon s13*)17:20, *s13-001*
 Rodriguez Lopez, Joaquin,
 (*Mon s16*)10:30, (*Thu 10*)15:40,
s07-042, s16-031
 Rodríguez, Paloma, (*Fri 06*)11:30
 Rodriguez, Paramaconi, (*Thu 07*)14:20,
 (*Thu 10*)15:40, *s18-015*
 Rodríguez Presa, María José, *s02-022*
 Rodriguez, Raul, *s06-020*
 Rodríguez-García, Adrián, *s09-014*
 Rodriguez-Martinez, Oliver,
 (*Mon s16*)17:20, *s02-010*
 Rodríguez-Valadez, F. J., *s07-101*
 Rodríguez-Varela, Francisco-Javier,
s07-078, s07-115, s07-121
 Rögner, Matthias, (*Tue s03*)10:10
 Römelt, Christina, *s11-050*
 Rohan, James, (*Fri 02*)10:10, *s06-057*
 Rohloff, Martin, *s03-045*
 Rohr, Udo, *s01-026*
 Rohwerder, Michael, (*Tue s13*)17:40,
 (*Wed s13*)10:30
 Roisnel, Thierry, (*Fri 07*)11:30
 Rojas, Camila, *s18-030*
 Rojas, Victor, *s10-050*

- Rojas-Carbonell, Santiago, *s05-001*
 Roldan, Beatriz, (*Thu 18*)16:40
 Roldan-Martinez, Alberto, *s16-050*
 Rolle, Sebastien, *s10-037, s15-010*
 Roman, Javier, *s03-034, s10-050, s18-034*
 Romero, Mario, *s10-050, s10-087*
 Romero-Romo, Mario, *s01-022, s09-013, s20-033, s20-062*
 Rommerskirchen, Alexandra, *s09-007*
 Rondinini, Sandra, (*Thu 10*)15:40, *s10-011, s16-014*
 Rong, Yuanyang, *s02-011*
 Ronsmans, Jan, (*Mon s08*)10:30
 Ros, Carles, (*Fri 18*)10:10
 Rosales, Mario, *s11-035*
 Rose, Sarah, *s20-051*
 Rosenkranz, Marco, *s15-042*
 Ross, Natasha, *s06-025*
 Ross, Thomas, (*Fri 02*)11:10
 Rossignol, Cecile, (*Mon s06*)18:20
 Rossmeis, Jan, (*Mon s17*)14:00, (*Mon s16*)15:00
 Rost, Marcel, *s16-038*
 Rostami, Abbasali, *s02-045, s02-046*
 Rostami, Hussein, *s02-045*
 Rostkowska, Natalia, *s02-047*
 Roth, Christina, (*Wed s07*)09:30, (*Thu 07*)15:20, *s07-033, s07-039*
 Rothenberg, Gadi, (*Thu 07*)09:30
 Roubalik, Martin, *s11-031*
 Rouhana, Jad, *s03-007*
 Rouillard, Fabien, (*Tue s13*)09:30
 Rousse, Gwenaëlle, (*Thu 06*)17:00
 Roy, Claudie, (*Thu 18*)18:20, *s18-019*
 Roznyatovskaya, Nataliya, (*Wed s07*)10:10
 Rubertelli, Francesca, *s07-043*
 Rubinstein, Israel, (*Fri 10*)11:10
 Rückle, Dagmar, *s20-034*
 Rueda, Manuela, (*Wed s03*)10:20, *s16-048*
 Rüdiger, Olaf, (*Tue s03*)14:40, *s03-050*
 Rümmler, Stefan, (*Wed s07*)10:30, *s07-044*
 Ruff, Adrian, (*Tue s03*)10:10, (*Tue s03*)14:40, (*Thu 18*)14:40, *s03-015, s03-050*
 Ruggeri, Irene, (*Fri 06*)11:30
 Ruhlmann, Laurent, (*Thu 10*)15:00, *s10-024, s10-057*
 Ruiz, Vanesa, (*Thu 12*)15:20, *s06-058*
 Ruiz-Rosas, Ramiro, *s10-053*
 Ruiz-Valdepeñas Montiel, Víctor, (*Thu 04*)14:00
 Ruiz-Zepeda, Francisco, (*Fri 07*)11:30, *s10-015*
 Ruotolo, Luis, *s09-008, s11-036*
 Rupp, Jennifer L. M., (*Mon s06*)10:30
 Russel, Victoria, *s03-001*
 Russell, Andrea, (*Mon s07*)17:20, (*Tue s07*)10:10, (*Thu 07*)17:00, *s02-036, s07-087, s07-105, s07-112, s10-093, s16-047*
 Russo, Nunzio, *s11-029, s18-004*
 Rustam, Lina, *s03-049*
 Rutkowska, Iwona A., (*Thu 10*)16:00, *s02-009, s03-009, s10-012, s15-024, s18-006*
 Ružić, Ivica, *s03-029*
 Ryabova, Anna, (*Thu 07*)18:00, *s07-116*
 Ryder, Karl S., (*Tue s08*)16:00, (*Tue s14*)16:00, (*Tue s16*)16:00, (*Thu 10*)14:00, (*Thu 20*)14:20, *s11-051, s14-004, s20-051*
 Ryu, Ji Heon, *s06-021, s06-034*
 Ryu, Saebom, *s06-123*
- S**
 Saar, Rando, (*Thu 07*)15:20
 Saballus, Martin, (*Mon s13*)18:20
 Sabate, Neus, (*Thu 12*)16:40
 Sabatino, Simona, (*Mon s11*)17:00
 Sadanayake, Saman, *s04-004*
 Saeedi Maleki, Mahsa, *s18-036*
 Sáez, Cristina, (*Tue s11*)16:00, (*Tue s11*)17:00, *s11-008, s11-038, s11-042, s11-042, s20-040*
 Safari, Mojtaba, *s10-018*
 Safo, Isaac Adjei, (*Tue s07*)18:20, *s10-005*
 Safrany-Renard, Marianne, (*Fri 06*)11:10
 Sainz, Raquel, *s03-003*
 Saito, Hiroyuki, *s13-015*
 Sajjadi, Sharareh, *s02-058*
 Sakamoto, Kazuki, *s03-023*
 Sakaushi, Ken, (*Tue s07*)15:40
 Sakiyama, Yoko, *s07-120*
 Sakurai, Yoji, (*Tue s06*)17:40, *s06-059*
 Sala, Martin, *s10-015*
 Salaj-Kosla, Urszula, *s03-010*
 Salazar, Ricardo, (*Tue s11*)15:20, *s01-043, s11-043, s11-044, s11-057, s16-037*
 Salazar-Banda, Giancarlo, (*Tue s11*)15:00, *s02-019, s09-015, s09-016*
 Salcedo, Inmaculada, *s05-009*
 Sallard, Sébastien, (*Thu 06*)10:10
 Sallum, Loriz, (*Fri 07*)11:10
 Salmi, Zakaria, *s18-010*
 Salter, Chris, *s20-035*
 Salvador, Michele, *s16-018*
 Salvatore, Daniele, (*Tue s01*)10:10,
 Samejima, Shogo, *s14-011*
 Sammelseig, Väino, (*Fri 20*)11:10, *s10-049*
 Sampath, Srinivasan, *s10-071*
 Samyn, Nele, *s03-060*
 Sanad, Moustafa, (*Mon s06*)18:20
 Sanchez-Castro, Maria E., *s07-078, s07-115, s07-121*
 Sanchez-Herencia, Antonio Javier, *s14-016*
 Sánchez-Solís, Ana, *s12-009*
 Sánchez-Tovar, Rita, *s10-060, s10-061, s10-066, s10-067, s10-073, s10-074*
 Sancy, Mamié, *s13-022*
 Sand, Wolfgang, (*Tue s13*)17:00
 Sandberg, Robert, (*Tue s16*)15:00
 Sandin, Staffan, *s11-037*
 Sandoval, Miguel, (*Mon s11*)15:40
 Sandulescu, Robert, *s02-023, s02-049, s03-053, s04-005, s10-029, s10-088*
 Sanginov, Evgeniy, *s06-015*
 Sanjuán, Ignacio, *s01-019*
 Sannicolò, Francesco, (*Mon s01*)15:40, *s01-001*
 Santamaria, Monica, (*Tue s13*)16:40, *s07-117*
 Santana, Juan J., (*Tue s13*)18:20
 Santana Santos, Carla, *s20-017*
 Santiago, Juan, (*Tue s09*)09:30
 Santiago, Mariângela, *s09-010*
 Santo-Pena, Jesus, *s08-040, s08-041*
 Santoro, Carlo, *s02-007, s05-001, s09-017*
 Santos, Elisama, (*Tue s11*)17:00, *s11-038*
 Santos, Elizabeth, *s16-052*
 Santos, Géssica, *s09-015*
 Santos Pena, Jesus, *s06-103*
 Santos, Tarciso, *s09-016*
 Sanz, Fausto, (*Wed s03*)09:50, *s16-044*
 Sanz, Laura, *s11-039*
 Sapstead, Rachel, (*Tue s16*)16:00
 Sar, Taner, *s06-098*
 Sarıçayır, Hakan, *s10-077*
 Saracco, Guido, *s18-004*
 Sarapuu, Ave, (*Thu 07*)15:20, *s16-006*
 Sarfraz, Adnan, *s07-021*
 Sarkar, Biprajit, (*Mon s15*)15:20
 Sarkar, Sahana, *s01-015*
 Sarnowska, Marta, (*Mon s07*)18:00
 Sarodnik, Hannes, (*Mon s07*)09:30
 Sasakawa, Ren, *s02-013*
 Sasaki, Hiroki, *s10-007*
 Sasaki, Keidai, *s06-077*
 Sasaki, Kuniaki, (*Fri 13*)11:30, *s10-007*
 Sato, Hiroaki, (*Fri 10*)11:30
 Sato, Kazutaka, *s11-054*
 Saucedo, Edgardo, (*Fri 18*)10:10
 Saujet, Laure, (*Mon s03*)10:10
 Savall, André, *s11-024*
 Savan, Alan, (*Thu 07*)16:40
 Saveleva, Viktoriia, (*Mon s07*)18:20, (*Wed s16*)09:50, *s07-144*
 Savinova, Elena, (*Mon s07*)18:20, (*Wed s16*)09:50, (*Thu 07*)17:00, (*Thu 07*)18:00, *s07-116, s07-144*
 Saw, En Ning, (*Mon s01*)15:00, *s02-072*
 Sawaguchi, Yuki, (*Fri 07*)09:50, *s11-030*
 Sawczak, M., *s08-036*
 Sayed, Sayed Y., (*Thu 07*)16:40
 Scanlon, Michéal D., *s16-028*
 Schaetzle, Olivier, (*Tue s09*)14:00
 Schafzahl, Lukas, (*Thu 06*)18:20
 Schalenbach, Maximilian, *s07-022*
 Schardt, Simon, (*Thu 06*)15:20, *s06-131*
 Scharifker, Benjamin, *s20-062*
 Scheiba, Frieder, *s07-039*
 Schektman, Inna, (*Tue s06*)14:00
 Scheller, Frieder W., *s03-013, s03-045, s03-049*
 Schennach, Robert, (*Thu 16*)09:30
 Scherf, Ullrich, *s10-034*
 Scherson, Daniel, (*Wed s10*)10:30
 Scheuble, Dirk, (*Mon s07*)14:20
 Scheurer, Christoph, *s17-009*
 Schiavo, Benedetto, (*Mon s11*)17:00
 Schiller, Carl-Albrecht, (*Mon s13*)17:40
 Schimpf, Sabine, *s07-044*
 Schizodimou, Agoritsa, *s20-023*
 Schjötzt, Jakob, (*Mon s16*)15:00
 Schleutker, Marco, *s06-136*
 Schloegl, Robert, (*Mon s07*)09:50
 Schmickler, Wolfgang, *s16-052*
 Schmidt, Sebastian, (*Thu 06*)10:10
 Schmidt, Thomas Justus, (*Tue s07*)18:00, (*Fri 07*)11:50, *s07-129*
 Schmies, Henrike, *s07-059*
 Schmuki, Patrik, (*Fri 10*)09:30, *s02-063, s02-064, s02-066, s06-054, s07-013, s10-009, s10-010, s10-063, s10-068, s13-016, s18-033, s20-026, s20-027*

- Schneider, Jörg J., *s03-024*
 Schneider, Michael, *s01-003*
 Schneider, Rudolf, *s20-047*
 Schneier, Dan, (*Mon s06*)16:40
 Schnitker, Jan, (*Tue s03*)16:40
 Schönleber, Konrad, (*Mon s13*)09:30,
 (*Tue s16*)10:30
 Scholz, Fritz, (*Mon s17*)16:00
 Schott, Pascal, (*Mon s07*)14:00
 Schouten, J.C., (*Mon s11*)09:50
 Schouten, Klaas Jan, (*Thu 18*)14:00
 Schrebler, Ricardo, *s10-050, s10-097,*
s18-011, s18-030, s18-034
 Schreiber, Anna, (*Mon s08*)15:00,
 (*Tue s08*)15:40, *s08-033*
 Schreier, Marcel, (*Fri 18*)11:10
 Schütter, Christoph, (*Mon s08*)14:40
 Schuhmann, Wolfgang, (*Mon s01*)16:00,
 (*Tue s03*)10:10, (*Tue s03*)14:40,
 (*Tue s03*)15:40, (*Thu 18*)14:40,
 (*Thu 10*)15:00, (*Thu 07*)18:20,
 (*Fri 20*)09:30, *s01-017, s01-045,*
s02-002, s02-030, s03-015, s03-017,
s03-022, s03-050, s03-056, s03-059,
s04-031, s06-091, s07-003, s07-019,
s07-089, s07-143, s20-019, s20-043
 Schuler, Tobias, (*Thu 07*)14:20
 Schulze, Patricia, *s07-097*
 Schuppert, Anna K., (*Tue s07*)14:00,
 (*Tue s07*)14:00
 Schwager, Patrick, (*Tue s01*)15:20
 Schwarz, Björn, *s06-062*
 Schwarzacher, Walther, (*Thu 16*)10:10
 Schweinebarth, Hannah, *s06-017*
 Schweinfurth, David, (*Mon s15*)15:20
 Scialdone, Onofrio, (*Mon s11*)17:00,
s11-040
 Scott, Keith, *s07-004*
 Sebastian Pascual, Paula, (*Mon s16*)14:00
 Sebastien, Bozdech, *s02-012*
 Seca, Helga F., *s11-019*
 Sechi, Elisa, (*Mon s11*)17:20, *s10-069*
 Seddon, James R. T., *s08-002*
 Sedghi, Gita, (*Thu 16*)10:10
 Sedgwick, Adam C., (*Tue s01*)17:00
 Sedighi, Majeed, *s02-046*
 Seidlmayer, Stefan, (*Tue s01*)15:00
 Sek, Slawomir, (*Tue s03*)17:40
 Seker, Erkin, (*Mon s03*)14:40
 Sekli Belaïdi, Fadhila, (*Thu 04*)17:20
 Selih, Vid Simon, *s10-015*
 Sella, Catherine, (*Thu 04*)17:40, *s04-030*
 Sellin, Annicka, (*Mon s11*)10:30
 Selt, Maximilian, *s11-050, s11-052*
 Selva, Thiago, *s20-010*
 Semaan, Felipe, *s01-048*
 Seno, Yoshiki, (*Wed s16*)10:10
 Senokos, Evgeny, (*Tue s08*)18:00,
 (*Thu 09*)09:50
 Sensi, Matteo, (*Mon s03*)10:10
 Sentosun, Kadir, (*Thu 10*)14:00,
 (*Thu 10*)17:00
 Seo, Hyunwoong, *s10-070*
 Seo, Jeongwook, *s01-011*
 Seppälä, Jukka, *s07-085*
 Sepúlveda-Guzmán, Selene, *s18-013*
 Serdechnova, Maria, (*Tue s13*)17:20
 Sereda, Olga, *s10-031*
 Sergeyev, Vladimir, *s03-052*
 Serov, Alexey, *s05-001, s09-017*
 Serrà, Albert, *s07-118, s07-119*
 Serrano, Enrique, (*Fri 07*)10:50
 Serrapede, Mara, (*Mon s08*)16:00, *s16-049*
 Seselj, Nedjeljko, *s10-019*
 Seta, Ewelina, *s03-009*
 Seuss, Sigrid, *s14-015*
 Seviour, Thomas, *s02-007*
 Seyeux, Antoine, *s06-075*
 Seymour, Ian, (*Fri 02*)10:10
 Sezen, Hikmet, *s16-043*
 Sez nec, Vincent, (*Thu 06*)17:00
 Shafiee, Saiful Arifin Bin, (*Fri 20*)11:30
 Shah, Imran, (*Fri 06*)09:30
 Shahraei, Ali, (*Tue s07*)15:20, *s18-024*
 Shamraeva, Maria, *s10-031*
 Shang, Yang, *s16-029*
 Shanmugam, Sangaraju, *s07-001*
 Shao, Hsin, *s09-023*
 Shao, Lidong, *s02-006*
 Shao, Pei-Sian, *s06-060*
 Shao-Horn, Yang, (*Thu 07*)16:40,
 (*Thu 07*)17:20
 Sharikov, Felix, *s06-065*
 Sharman, Jonathan, *s02-036*
 Sheikh, Khizar, (*Tue s03*)09:30
 Shen, Chong-Heng, *s06-022*
 Shen, Fei, *s03-027*
 Shen, Hsiao-Hsuan, (*Tue s08*)14:00
 Shen, Hsin-Hui, *s08-035*
 Shen, Jing, *s15-029, s17-008*
 Shen, Yuhua, *s02-080, s06-076*
 Sheng, Tian, (*Thu 07*)15:40,
 (*Thu 20*)17:20, *s07-093, s07-133,*
s15-031
 Shi, Kang, (*Fri 13*)10:10
 Shi, Xiaobo, *s08-044*
 Shi, Yi, (*Fri 02*)09:50
 Shiba, Shunsuke, *s01-046*
 Shih, Bing-Yi, *s06-060, s08-026*
 Shiku, Hitoshi, (*Mon s01*)14:40, *s02-057*
 Shima, Asuka, *s11-054*
 Shimada, Hiroyuki, *s07-145*
 Shimada, Iori, *s07-071*
 Shimizu, Ryo, *s07-120*
 Shimizu, Youichi, (*Tue s07*)16:00
 Shin, Chee Burm, *s12-006, s12-008*
 Shin, Ha Eun, *s11-003, s11-005*
 Shin, Jeongyim, *s06-061*
 Shin, Samuel Jaeho, *s14-013, s16-035*
 Shin, Woon sup, *s04-021*
 Shinde, Ganesh, (*Wed s06*)09:50
 Shirai, Soichi, *s18-012*
 Shiratani, Masaharu, *s10-070*
 Shironita, Sayoko, (*Tue s13*)18:00,
s07-072, s11-054
 Shitanda, Isao, (*Tue s13*)10:10, *s03-025,*
s03-063
 Shkirskiy, Viacheslav, (*Mon s13*)09:50,
 (*Mon s13*)14:20
 Shleev, Sergey, *s03-003, s03-015, s03-017*
 Shmygleva, Lyubov, *s06-137, s06-138*
 Shocron, Amit, *s09-004*
 Shodiev, Muzaffar, (*Thu 03*)09:50
 Shollock, Barbara, *s13-023*
 Shou, Binan, *s13-019*
 Shrestha, Buddha, *s07-082, s10-004*
 Shrotri, Nivedita, *s07-107*
 Shukla, A., (*Tue s06*)14:20
 Shum, Andrew, (*Thu 07*)14:00
 Sieber, Volker, *s18-026*
 Siegbahn, Hans, (*Thu 16*)09:50
 Siepenkoetter, Till, *s03-010*
 Sierczynska, Agnieszka, *s08-007, s08-016,*
s08-017
 Sigalaev, Sergey, *s06-063*
 Sigel, Florian, *s06-062*
 Siimenson, Carolin, *s16-030, s16-041*
 Siinor, Liis, *s16-030*
 Siller-Ceniceros, Adriana, *s07-115,*
s07-121
 Silva, Ana, *s01-048*
 Silva, Bianca Ferreira, *s20-048*
 Silva, Everson, *s11-041*
 Silva, Gabriel, (*Fri 07*)11:10
 Silva, José Ricardo, *s20-011*
 Silva, Leticia, *s09-015*
 Silva, Rejane, *s07-075*
 Silva, Rosanny C., (*Tue s15*)10:30
 Silva, Teresa Maria, *s08-025*
 Silva, Thaissa Lucio, (*Tue s15*)10:30
 Silva, Tiago, *s01-025, s02-026, s02-027*
 Silveira, Dâmaris, *s04-027*
 Silverberg, Gregory, (*Tue s09*)14:40
 Simic, Nina, (*Mon s11*)09:30,
 (*Mon s11*)10:30, *s11-053*
 Simillion, Hans, (*Tue s13*)15:20
 Simka, Wojciech, *s13-004*
 Simková, Ludmila, *s15-016*
 Simon, Leijonmarck, *s06-017*
 Simpson, Burton, (*Thu 10*)15:40, *s16-031*
 Sin, Ion, *s14-002*
 Sinev, Ilya, (*Thu 07*)18:20, *s07-089*
 Singh, Deepak Pratap, (*Tue s01*)14:40
 Singh, Dheeraj Kumar, *s10-071*
 Singh, Yadvinder, (*Thu 07*)15:00
 Single, Fabian, *s16-053*
 Sinh, Le Hoang, *s07-085*
 Sinha, Rochan, *s02-061*
 Sinstein, Markus, *s16-054*
 Siradini, Eirini, *s02-034*
 Sirés, Ignacio, (*Tue s11*)15:40
 Sirés, Ignasi, *s11-016*
 Siuzdak, Katarzyna, *s08-036*
 Sjödin, Martin, (*Thu 10*)17:20, *s10-026,*
s10-030, s10-038, s10-041
 Skládál, Petr, *s02-025*
 Skompska, Magdalena, (*Fri 10*)10:50
 Skorupsky, Gregory, *s06-106*
 Skrydstrup, Troels, *s18-010*
 Skundin, Alexander, *s06-063, s06-096,*
s06-104
 Skunik-Nuckowska, Magdalena,
 (*Tue s08*)16:40, *s16-005*
 Slavcheva, Evelina, *s07-005, s07-023*
 Slegers, Nick, *s01-027, s03-060*
 Slesinski, Adam, *s08-020*
 Sleutels, Tom, (*Wed s05*)10:10
 Sliozberg, Kirill, (*Fri 20*)09:30
 Sliusarenko, Oleksii, *s20-012*
 Slugovc, Christian, (*Fri 06*)10:10
 Smirnov, Evgeny, *s15-035*
 Smith, Emma, (*Tue s16*)16:00
 Smith, Graham T., (*Tue s07*)10:10
 Smith, John, *s06-116*
 Smith, Kyle, (*Wed s09*)10:30, *s07-042*
 Smith, Raymond B., (*Thu 12*)18:20
 Smith, Wilson, *s18-009*

- Snihirova, Darya, (*Tue s13*)17:20, (*Wed s13*)09:30
 Snita, Dalimil, *s07-067*
 So, Seulgi, *s02-066, s10-063*
 Soavi, Francesca, (*Mon s08*)17:00, (*Fri 06*)11:30, *s09-017*
 Sobkowiak, Adam, (*Tue s06*)10:10
 Sobolev, A., *s06-104*
 Soccol, Dimitri, (*Tue s14*)14:00
 Socha, Robert, *s13-004*
 Sode, Koji, (*Thu 04*)16:40
 Sodeyama, Keitaro, *s06-113*
 Soeda, Kazunari, (*Mon s08*)14:20
 Sönmez, Turgut, (*Thu 07*)17:00
 Sojic, Neso, (*Tue s01*)17:00, (*Tue s03*)18:20, (*Thu 04*)17:20, *s02-053*
 Solarska, Renata, (*Mon s07*)18:00, *s18-006*
 Soldà, Alice, (*Thu 04*)14:40, (*Thu 04*)18:20
 Sole, Christopher, *s06-079*
 Soler-Vicedo, Miguel, *s07-114*
 Soleymani, Leyla, (*Thu 02*)09:30
 Solik, Milan, *s07-041*
 Soliman, Hesham, *s07-106*
 Solla-Gullón, Jose, *s01-019, s01-020, s16-006, s18-015*
 Soltero, J.F. Armando, (*Mon s03*)15:20
 Soma Vesztergom, Tamas Pajkossy, (*Sun 25*)14:20
 Sommariva, Marco, (*Tue s01*)15:00
 Son, Min-Kyu, (*Fri 18*)11:10, *s10-070*
 Sone, Yoshitsugu, *s06-049, s06-066, s11-054*
 Song, Congying, *s02-073*
 Song, Hyun-Kon, *s06-029, s20-028*
 Song, Juhye, *s06-033, s06-105*
 Song, Jun-Ho, *s06-011*
 Song, Kyeongse, *s06-093*
 Song, Qilei, *s02-011*
 Song, Yanyan, *s03-062*
 Song, Yonggui, *s04-022*
 Song, Yonghai, *s02-014, s03-011, s04-022, s06-073*
 Song, Yu, *s08-027*
 Sopha, Hanna, (*Tue s13*)16:00, *s10-044*
 Sorsa, Olli, *s07-122*
 Sorte, Eric G., (*Tue s16*)09:30
 Sosnowska, Marta, (*Mon s03*)17:00
 Sotiropoulos, Sotiris, (*Thu 20*)16:40, *s10-014*
 Soucaille, Philippe, (*Mon s03*)10:10
 Sougrati, Moulay Tahar, (*Tue s07*)14:00
 Soukura, Masanori, (*Tue s13*)10:10
 Souma, Kenichi, (*Tue s13*)18:00
 Sousa, Camila, *s16-018*
 Sousa, Nyccolas, (*Fri 07*)11:10
 Souto, Ricardo M., (*Tue s13*)18:20
 Sowa, Maciej, *s13-004*
 Spallek, Markus J., *s13-005*
 Spanos, Ioannis, (*Mon s07*)09:50
 Sperling, Eva, (*Thu 18*)15:40
 Spingler, Franz, (*Thu 07*)14:20
 Spoeri, Camillo, *s07-024*
 Spohr, Eckhard, (*Mon s17*)15:20
 Spragg, Aurora, (*Tue s09*)15:20
 Sprinzl, Georg, *s04-016*
 Squella, Juan Arturo, *s10-101*
 Srabionyan, Vasilii, *s07-056*
 Srikanth, Sandipam, *s18-027*
 Stadermann, Michael, (*Tue s09*)09:30
 Stadler, Hartmut, (*Tue s01*)18:20
 Stamp, Lutz, *s11-045*
 Stanbury, Matthew, (*Fri 18*)10:50
 Stanislav, Fedotov, (*Fri 06*)11:50
 Stapf, Stefanie, (*Tue s03*)14:40, (*Thu 18*)14:40, (*Thu 10*)17:00, *s03-050*
 Stappers, Linda, (*Tue s14*)14:00
 Starace, Marco, *s06-130*
 Stárek, Jirí, *s06-032*
 Stark, Robert, (*Tue s07*)15:20
 Stefani, Frank, *s06-129, s06-130*
 Steffler, Fabian, *s18-026*
 Steier, Ludmilla, (*Fri 18*)11:10
 Steimecke, Matthias, (*Wed s07*)10:30, *s07-044*
 Steinberg, Julian, (*Thu 07*)17:20
 Steinhäuser, Edith, *s11-045*
 Steinhauer, Miriam, *s06-064*
 Steinke, Nina-Juliene, (*Tue s16*)16:00
 Stelliling, Christian, (*Tue s01*)18:20
 Stenina, Irina, *s06-104*
 Stephens, Ifan, (*Mon s07*)10:30, (*Mon s16*)15:00, (*Tue s07*)17:20
 Stepkowski, Tomasz, (*Mon s03*)16:00
 Sterby, Mia, (*Thu 10*)17:20, *s10-038*
 Sterlin, Sergey, *s15-005*
 Stern, Christine, *s10-037*
 Stevenson, Keith, *s06-013*
 Steyskal, Eva-Maria, *s07-123, s16-032*
 Stieger, Kai R., (*Thu 18*)15:20, *s03-006*
 Stievano, Lorenzo, (*Mon s06*)17:00
 Stimming, Ulrich, (*Wed s07*)09:50
 Stockmann, T. Jane, (*Mon s15*)10:10
 Stoerzinger, Kelsey, (*Thu 07*)16:40, (*Thu 07*)17:20
 Stoica, Leonard, (*Tue s03*)10:30
 Stojanovic, Ivan, *s13-026*
 Stojek, Zbigniew, *s10-020*
 Stolarczyk, Krzysztof, (*Wed s03*)10:30, *s03-026*
 Stoll, Thibaut, *s18-040*
 Stolten, Detlef, *s06-028, s06-136, s07-022*
 Stortini, Angela Maria, *s01-016, s02-074*
 Stoyanova, Antonia, *s08-039*
 Stradiotto, Nelson, *s20-035*
 Straß, Benjamin, (*Fri 13*)09:30
 Strasser, Peter, (*Mon s07*)09:30, (*Mon s07*)10:10, (*Tue s07*)16:40, (*Thu 18*)16:40, (*Thu 07*)17:20, *s07-024, s07-059*
 Strauss, Steven H., *s15-042*
 Streich, Daniel, (*Tue s06*)18:00
 Strik, David, (*Thu 18*)15:00
 Stroek, Wowa, (*Thu 07*)09:30
 Strohmeier, Gernot A., (*Thu 06*)17:20
 Strunz, Werner, (*Mon s13*)17:40
 Struzik, Michal, (*Mon s06*)10:30
 Strømme, Maria, (*Thu 10*)17:20, *s06-072, s08-022, s10-026, s10-030, s10-038, s10-041*
 Stutz, Guillermo, *s06-052*
 Su, Chun-Hao, *s10-082*
 Su, Haixia, *s10-021*
 Su, Qiang, (*Mon s01*)17:40, *s03-042*
 Su, Xiao, (*Wed s09*)09:30, *s09-019*
 Su, ZhanFei, (*Wed s03*)10:20
 Su, Zhangfei, (*Thu 03*)09:50, *s04-013*
 Subhramannya, Mahima, (*Fri 13*)11:50
 Suda, Atsushi, (*Mon s01*)14:40
 Sudhagar, P., *s03-063*
 Sudhölter, Ernst, *s03-033*
 Suffredini, Hugo Barbosa, *s01-039, s07-075*
 Suganuma, Yoshitake, (*Wed s16*)10:10
 Sugimoto, Toshinori, *s06-123*
 Sugimoto, Wataru, (*Tue s08*)10:10
 Sugimura, Fumiya, (*Tue s16*)18:00
 Suiyama, Jun, (*Wed s16*)10:10
 Sukeri, Anandhakumar, *s02-004*
 Sulka, Grzegorz, (*Tue s08*)14:40, (*Fri 10*)09:50, *s10-043, s10-051, s10-052, s10-081*
 Sumanov, Vasily, *s06-013, s06-065*
 Sun, Chia-Liang, *s10-082*
 Sun, Dennis, *s07-124*
 Sun, Hui, *s10-021*
 Sun, Juan-Juan, *s16-045*
 Sun, Junliang, *s06-014*
 Sun, Shi-Gang, (*Thu 07*)15:40, (*Thu 20*)17:20, *s06-022, s07-012, s07-093, s07-133, s10-006, s15-031*
 Sun, Xiaofei, *s06-020*
 Sun, Yang-Kook, (*Tue s06*)15:40
 Sun, Yong, *s07-008*
 Sun, Zhenyu, *s07-143*
 Sunami, Shodai, *s03-023*
 Sunseri, Carmelo, (*Fri 10*)10:50, *s04-020, s07-010, s07-011*
 Suominen, Milla, *s08-028*
 Surendranath, Yogesh, (*Tue s16*)14:40, *s18-017*
 Surucu, Ozge, *s02-048*
 Susman, Mariano D., (*Fri 10*)11:10
 Suss, Matthew, (*Tue s09*)18:20, *s09-002, s09-004*
 Sutter, Eljane, (*Tue s13*)15:40
 Suzuki, Norihiro, *s03-063*
 Suzuki, Shohei, *s20-054*
 Suzuki, Takuma, (*Thu 12*)14:40
 Svens, Pontus, *s06-075*
 Svir, Irina, (*Tue s03*)17:20, *s20-012*
 Svoboda, Milos, *s07-038*
 Svoboda, Vojtech, *s07-037*
 Swaans, Ellie, *s06-107*
 Swiatowska, Jolanta, *s06-075*
 Swider, Joanna, *s10-072*
 Swiech, Olga, (*Mon s03*)16:00
 Swietlikowska, Agnieszka, (*Thu 20*)18:20
 Swietoslowski, Michal, *s06-004*
 Syrek, Karolina, (*Fri 10*)09:50, *s10-052*
 Szaniawska, Ewelina, *s18-006*
 Szkoda, Mariusz, *s08-036, s18-022*
 Szunerits, Sabine, (*Fri 02*)09:30
 Szwabinska, Katarzyna, (*Mon s03*)17:00
 Szymczyk, Joanna, (*Tue s08*)16:40
- T**
 Tabachkova, Natalya, *s07-056, s07-057*
 Tabarant, Michel, (*Tue s13*)14:40
 Tacca, Alessandra, *s07-043*
 Tadmor, Ellad, (*Tue s14*)14:00
 Tahara, Yoshiyuki, *s06-101*
 Taher, Mahmoud, *s07-106*
 Taj, Naveen, (*Fri 13*)11:50
 Tak, Yongsug, *s06-111, s07-109*
 Takada, Haruki, *s07-072*
 Takahashi, Naoko, (*Wed s16*)10:10

- Takahashi, Nobuhide, *s07-071*
 Takano, Jun, (*Thu 07*)14:40, *s07-120*
 Takanohashi, Kazuhiro, *s07-083*
 Takase, Satoko, (*Tue s07*)16:00
 Takeguchi, Tatsuya, *s02-015*, *s06-088*,
s07-104
 Taketsugu, Tetsuya, (*Mon s16*)18:20
 Taladriz-Blanco, Patricia, *s04-029*
 Taleb, Masoud, *s04-023*
 Tamariz, Angel, *s07-125*
 Tammela, Petter, *s06-072*, *s08-022*
 Tammeveski, Kaido, (*Thu 07*)15:20,
 (*Fri 20*)10:50, (*Fri 20*)11:10, *s10-049*,
s16-006
 Tamura, Yuko, *s07-081*, *s07-126*
 Tan, Sze-yin, *s17-013*
 Tanaka, Kohei, *s06-066*
 Tanaka, Shoji, *s07-072*
 Tanami, Sota, *s10-070*
 Taniguchi, Shuichi, *s06-049*
 Tanner, David, *s03-012*
 Tanyeli, Irem, *s02-061*
 Tao, Ying, *s08-023*
 Tarnev, Tsvetan Hristov, *s03-059*
 Taryba, Maryna, (*Tue s13*)17:20
 Tateyama, Yoshitaka, *s06-113*
 Taucher-Mautner, Waltraud, *s07-045*
 Tavakkoli, Mohammad, *s07-025*
 Tawa, Hayato, (*Tue s06*)17:40
 Taylor, Isaac, *s04-006*
 Taylor, Stuart H, *s02-011*
 Tedesco, Michele, *s17-011*
 Teik Zheng, Alvin Lim, *s10-095*
 Teixeira, Valeria, (*Wed s13*)10:10
 Temmel, Sandra Elisabeth, *s07-129*
 Tempel, Hermann, (*Mon s06*)15:00,
s10-023
 Temple-Boyer, Pierre, (*Thu 04*)17:20
 Tender, Leonard, (*Wed s05*)09:30
 Tengstedt, Carl, (*Tue s06*)10:10, *s06-075*
 Teodorescu, Florina, (*Fri 02*)09:30
 Ter Heijne, Annemiek, (*Wed s05*)10:10
 Terashima, Chiaki, *s03-063*
 Terborg, L., (*Tue s06*)14:20
 Tereshchenko, Ivan, *s06-106*
 Terryn, Herman, (*Tue s13*)15:20,
 (*Thu 10*)17:00, *s14-010*, *s20-061*
 Tertis, Mihaela, *s02-023*, *s02-049*, *s04-005*
 Teschner, Detre, (*Mon s07*)10:10
 Theleritis, Dimitrios, (*Mon s11*)17:40
 Thiam, Abdoulaye, *s11-043*
 Thiele, Simon, (*Mon s07*)15:20
 Thomä, Marco, (*Fri 13*)09:30
 Thomas, Anthony, *s06-067*
 Thouin, Laurent, (*Thu 04*)17:40, *s04-030*
 Thyssen, Christian, (*Tue s13*)17:00
 Tian, Na, (*Thu 20*)17:20
 Tian, Wenda, (*Wed s09*)09:30
 Tian, Zhong-Qun, (*Mon s16*)10:10,
s18-008
 Ticianelli, Edson A., (*Thu 07*)17:40,
s07-127
 Tiggelaar, Roald, *s18-039*
 Timperman, Laure, *s08-004*
 Tippkötter, Nils, *s05-002*
 Tisserant, Gwendoline, (*Thu 10*)10:10
 Titirici, Maria-Magdalena, *s07-098*
 Tobrman, Tomas, *s15-014*
 Toda, Takahiro, (*Mon s15*)15:40
 Todoroki, Naoto, *s02-013*
 Todorov, Yanko, (*Mon s06*)18:00
 Togashi, Taknari, (*Fri 10*)11:30
 Toghil, Kathryn, *s07-029*
 Toh, Her Shuang, *s20-035*
 Tojo, Tomohiro, (*Tue s06*)17:40, *s06-059*
 Tokieda, Hiroyuki, (*Tue s13*)10:10
 Tokur, Mahmud, *s06-002*, *s06-068*
 Tolmachev, Yury, *s07-028*, *s17-012*
 Tolosa, Aura, *s08-033*
 Tomani, Per, *s06-017*
 Tong, Yu Ye, (*Mon s16*)15:20,
 (*Tue s16*)09:30
 Tongol, Bernard John, *s07-001*, *s20-029*
 Torop, Janno, *s10-039*, *s10-040*
 Torralba Peñalver, Encarnacion,
 (*Thu 10*)14:40
 Torrente-Rodríguez, Rebeca M.,
 (*Thu 04*)14:00
 Torres, Ricardo, *s11-044*
 Torres-González, Julieta, *s09-014*
 Torres-Huerta, Aide M., *s07-128*, *s10-075*,
s13-002, *s13-012*
 Torres-Lubian, Jose, *s07-115*, *s07-121*
 Torresi, Roberto M., (*Mon s08*)15:20,
 (*Mon s08*)16:40, *s08-005*, *s10-027*,
s10-048
 Tory, Joanne, (*Thu 16*)10:10
 Toscano, Miguel D., *s03-003*
 Tóth, Péter S., (*Fri 10*)11:10
 Toulc'Hoat, Joël, *s08-004*
 Toulec, Milos, *s07-041*
 Toyoda, Masahiro, *s06-141*
 Tozzola, Gabriella, *s07-043*
 Tran, Chau Cam Hoang, *s08-040*, *s08-041*
 Tran, Hai Yen, (*Mon s08*)18:00
 Tran, Mai, (*Tue s13*)15:40
 Tran, Thi Bich Hue, (*Thu 07*)14:40
 Trari, Mohamed, *s10-079*
 Trashin, Stanislaw, (*Mon s03*)18:20,
s10-100
 Trattner, Stephan, (*Mon s07*)15:00
 Trelu, Clément, (*Tue s11*)16:40
 Tremiliosi-Filho, Germano,
 (*Mon s16*)15:40, (*Tue s16*)09:50,
s20-046
 Tresso, Elena, (*Mon s08*)16:00, *s16-049*
 Trettenhahn, Günter, *s10-035*
 Tribollet, Bernard, (*Tue s13*)15:40
 Trinh, Tuan Ngoc, *s09-005*
 Tripkovic, Vladimir, (*Mon s16*)15:00
 Trivinho-Strixino, Francisco, *s02-059*
 Trnkova, Libuse, *s01-049*, *s16-055*
 Trócoli, Rafael, *s20-021*
 Tromp, Hans, *s16-020*
 Truong, Yen, (*Fri 13*)09:50
 Trusovas, Romualdas, *s10-086*
 Trzciński, Konrad, *s08-036*
 Tsai, Han-peng, *s08-030*
 Tsai, Shu-Yi, *s07-095*, *s07-096*
 Tsai, Ting-Ti, *s08-035*
 Tsakova, Vesela, *s20-031*
 Tsamopoulos, John, *s07-100*
 Tsao, Jeffrey, *s11-046*
 Tschulik, Kristina, (*Thu 02*)14:20, *s02-006*,
s02-024, *s02-072*
 Tschupp, Simon A., (*Fri 07*)11:50, *s07-129*
 Tsé, Chantal, *s03-051*
 Tse, Edmund, (*Mon s16*)16:40
 Tsiplakides, Dimitrios, *s10-014*
 Tsirlina, Galina, (*Thu 07*)18:00, *s07-116*
 Tsuchiya, Hiroaki, (*Tue s13*)14:00
 Tsuda, Takao, *s06-059*
 Tsujimura, Seiya, (*Tue s03*)16:00, *s03-025*
 Tsumura, Tomoki, *s06-141*
 Tsunashima, Katsuhiko, *s20-057*
 Tucceri, Ricardo L., *s16-051*
 Tucker, Michael, (*Thu 07*)14:20
 Tudela, Ignacio, (*Mon s13*)14:40
 Tübke, Jens, (*Wed s07*)10:10
 Türkmen, Hayati, *s20-016*
 Tüysüz, Cengiz, *s10-077*
 Tüysüz, Harun, (*Thu 07*)10:10
 Tuomi, Sami, *s07-014*, *s07-130*
 Turek, Thomas, (*Mon s11*)16:40
 Tverskoy, Vladimir, (*Thu 10*)16:00
 Tybrandt, Klas, *s08-003*
 Tymoczko, Jakub, *s16-012*
 Tzedakis, Theo, (*Mon s11*)16:00,
 (*Tue s11*)18:20
- U**
 Uchida, Hiroyuki, (*Thu 07*)14:40,
 (*Fri 07*)10:50, (*Fri 07*)10:50
 Uchida, Makoto, (*Thu 07*)14:40, *s07-120*
 Uchida, Satoshi, (*Mon s08*)14:20
 Uchida, Taro, *s16-033*
 Uchidate, Michimasa, (*Fri 13*)11:30
 Uchimoto, Yoshiharu, (*Fri 06*)11:50
 Uebel, Matthias, (*Wed s13*)10:30
 Ueno, Yuko, *s04-009*
 Ugalde-Saldívar, Víctor-Manuel, *s15-028*
 Ugo, Paolo, *s01-016*
 Uhlemann, Margitta, *s07-018*
 Uhlin, Anders, *s06-017*
 Ui, Koichi, *s02-015*, *s06-088*, *s07-104*
 Ulgut, Burak, *s12-012*
 Ulissi, Ulderico, (*Thu 06*)09:50, *s06-069*
 Ulker, Emine, *s07-015*
 Ulstrup, Jens, (*Mon s03*)09:30,
 (*Thu 16*)10:10, *s03-012*, *s03-014*,
s10-019, *s10-090*
 Umeda, Minoru, (*Tue s13*)18:00, *s06-049*,
s07-072, *s11-054*
 Umukoro, Eseoghene, *s11-055*
 Unal, Asuman, (*Tue s08*)16:00,
 (*Thu 10*)14:00
 Ungeheuer, Jürgen, (*Thu 12*)15:20
 Ungureanu, Eleonora-Mihaela, *s01-050*,
s15-020
 Unwin, Patrick, (*Mon s15*)14:00,
 (*Tue s14*)15:00, (*Tue s03*)17:00,
 (*Fri 02*)11:50, *s03-046*, *s13-023*,
s16-025, *s16-039*, *s17-013*
 Uosaki, Kohei, (*Mon s16*)18:20,
 (*Tue s07*)15:40
 Upadhyay, Kush, *s08-029*
 Urbakh, Michael, (*Mon s17*)10:10
 Uribe-Godínez, Jorge, *s07-125*, *s07-131*
 Urlacher, Vlada, *s03-045*
 Urquiza, Laura, *s06-041*, *s06-042*
 Ustarroz, Jon, (*Tue s14*)15:00,
 (*Thu 10*)14:00, (*Thu 10*)17:00,
s14-010, *s20-061*
 Utagawa, Masahiro, *s06-059*
 Uyama, Masao, *s13-015*
 Uysal, Mehmet, *s06-002*

V

- Váňová, Hana, *s15-014*
 Vaalma, Christoph, (*Mon s06*)15:20,
*(Tue s06)*17:20, *s06-097*
 Vaca Chávez, Fabián, *s06-051*
 Vacca, Annalisa, *s18-001*, *s18-028*
 Vajjala, Venkata S.R., (*Thu 04*)17:20
 Vakros, John, *s11-025*
 Valcarce, Beatriz, (*Tue s13*)09:50, *s13-017*
 Valdinger, Ido, (*Thu 20*)15:40
 Valenti, Giovanni, (*Fri 10*)10:10,
*(Fri 10)*11:50, *s10-022*, *s15-030*,
s15-037
 Valentinuzzi, María Cecilia, *s06-051*
 Valiokas, Ramunas, *s10-080*
 Vallés, Elisa, *s02-031*, *s07-118*, *s07-119*,
s10-046
 Valvo, Mario, (*Wed s06*)09:30
 Van Bael, Marlies, *s06-082*
 van Bennekom, Joosje, (*Wed s19*)09:50
 van de Sanden, Richard, *s02-061*, *s17-014*
 Van de Wiele, Tom, (*Wed s05*)10:30
 van Deelen, Joop, (*Thu 10*)16:40
 van den Berg, Albert, (*Mon s01*)18:00,
s02-056
 van den Brink, Floris, (*Mon s01*)18:00
 van den Ham, Evert Jonathan, *s06-082*
 Van den Steen, Nils, (*Tue s13*)15:20
 van der Ham, Koen, *s15-039*
 van der Meer, Margarethe, (*Mon s15*)15:20
 van der Plas, Martijn, *s15-026*
 van der Schaaf, J., (*Mon s11*)09:50
 van der Vliet, Dennis, (*Thu 07*)14:20
 van der Waal, Jan Kees, (*Thu 18*)14:00
 van der Wal, Albert, (*Tue s09*)16:00,
s09-006
 Van Dijk, Nick, (*Mon s07*)16:40
 Van Durme, Filip, *s03-060*
 van Erkel, Joost, *s11-013*
 van Holt, Desiree, *s06-019*
 Van Hullebusch, Eric, (*Tue s11*)16:40,
s09-012
 Van Laethem, Dries, *s07-069*
 van Santen, Rutger, *s17-014*
 Vanamo, Ulriika, *s01-012*
 Vanbroekhoven, Karolien, (*Thu 18*)15:00,
s18-027
 Vancso, Julius, *s02-056*
 Vankelecom, Ivo, (*Thu 07*)17:40
 Vannikov, Anatoly, (*Thu 10*)16:00, *s10-033*
 Vanrenterghem, Bart, *s15-036*, *s20-036*
 Vanrompay, Hans, (*Thu 10*)14:00,
*(Thu 10)*17:00
 Varanda, Laudemir C., (*Thu 07*)17:40
 Varela, Ana Sofia, (*Thu 18*)16:40
 Varela, Hamilton, *s16-021*, *s20-046*
 Varela, Luis M., *s06-026*
 Varenne, Anne, *s04-029*
 Varga, Aron, *s07-097*
 Varini, Maria, *s06-070*
 Varnell, Jason, (*Mon s16*)16:40
 Varzi, Alberto, (*Thu 06*)09:50
 Vasile, Eugeniu, (*Thu 10*)15:00
 Vasileiadis, Alexandros, (*Thu 12*)18:20,
s06-016
 Vasilescu, Cora, *s13-013*
 Vaskevich, Alexander, (*Fri 10*)11:10
 Vayenas, Constantinos, (*Mon s11*)17:40,
s07-100, *s11-025*
 Vaz, Boniek Gontijo, *s01-053*, *s04-028*
 Vázquez-Galván, Javier, (*Fri 07*)11:50,
s11-039
 Vecitis, Chad, (*Tue s09*)14:40
 Vegge, Tejs, (*Mon s17*)15:40,
*(Mon s17)*18:20
 Vejar, Nelson, *s13-022*
 Vela-Diago, Bellatrix, *s10-074*
 Velazco, Nancy, *s05-010*
 Velazquez-Palenzuela, Amado,
*(Mon s16)*15:00
 Vélez, David, (*Tue s14*)18:00
 Vélez, J.F., *s06-050*
 Velez, Marisela, (*Mon s03*)10:30
 Vélez, Patricio, *s06-042*
 Venegas, Constanza, *s02-001*
 Ventosa, Edgar, (*Thu 10*)15:00, *s06-091*,
s07-003
 Verbickas, Rolandas, (*Mon s13*)14:40
 Vereecken, Philippe M., (*Wed s10*)10:10
 Verhoeven, Harrie, (*Thu 02*)10:10
 Verhulst, Kristof, *s11-032*
 Verlato, Enrico, (*Thu 10*)17:20,
*(Thu 10)*17:40
 Verliefde, Arne, (*Thu 09*)09:30
 Vertova, Alberto, *s10-011*, *s16-014*
 Vereecken, Robbe, (*Thu 18*)17:00, *s18-025*
 Vesely, Martin, (*Tue s11*)10:10
 Vessières, Anne, (*Thu 04*)17:40
 Vesztergom, Soma, *s16-027*
 Vezzoli, Andrea, (*Thu 16*)10:10
 Vicari, Fabrizio, (*Mon s11*)17:00, *s11-040*
 Vicentini, Fernando, *s02-020*, *s02-026*
 Vidal, Jorge, *s11-044*
 Vidal, Lorena, *s01-040*, *s01-041*
 Vidal-Iglesias, Francisco Jose, *s01-019*,
s01-020, *s18-015*
 Vieira de Melo, Jailson, *s11-022*
 Vieira, Luciana, (*Thu 16*)09:30, *s18-026*
 Vigier, Karine, (*Thu 20*)14:00, *s18-003*
 Vijayshankar, Dandapani, (*Tue s13*)17:40
 Viktor, Hacker, *s07-138*
 Vila, Neus, (*Thu 02*)18:00, (*Fri 10*)11:30,
s02-033, *s11-056*
 Vilana, Joan, *s07-119*
 Vilatela, Juan Jose, (*Tue s08*)18:00
 Villalonga, Reynaldo, *s10-088*
 Villani, Elena, *s15-037*
 Villaseñor, Jose, *s11-008*
 Villeveille, Claire, (*Thu 06*)10:10
 Villullas, Hebe de las Mercedes, *s07-073*,
s07-132
 Vimalanandan, Ashokanand, (*Wed*
s13)10:30
 Vinke, Izaak C., (*Mon s16*)14:20
 Virtanen, Sannakaisa, (*Mon s13*)16:40,
s14-017, *s20-034*
 Vis, Mark, *s16-020*
 Visan, Teodor, *s14-002*, *s14-003*
 Vittal, R., *s12-005*
 Vivancos-Ramón, María Victoria, *s20-009*
 Vivier, Vincent, (*Mon s13*)14:20,
*(Tue s13)*09:30
 Vizintin, Alen, (*Mon s06*)17:00
 Vlachopoulos, Nick, (*Thu 10*)17:40
 Vlaic, Codruta, *s16-024*
 Vlap, Harm, (*Thu 12*)17:40
 Vogelsang, Jörg, (*Mon s13*)17:40
 Vogt, Stephan, *s03-042*
 Vojtesek, Borivoj, (*Thu 04*)15:20
 Vojtisek, Pavel, (*Mon s15*)16:00
 Volgin, Vladimir, *s20-039*, *s20-041*,
s20-042
 Volkov, Anton, *s08-003*
 Volochaev, Vadim, *s07-056*, *s07-057*
 Volovitch, Polina, (*Mon s13*)09:50,
*(Mon s13)*14:20
 Von Eschwege, Karel G., *s20-044*
 von Srbik, Marie-Therese, (*Thu 12*)15:40
 Vondrák, Jirí, *s06-032*
 Vorotyntsev, Mikhail, (*Thu 10*)14:40,
s07-027, *s07-028*, *s07-034*, *s10-031*,
s10-032, *s10-037*, *s15-010*, *s17-012*
 Vos, Jan, (*Mon s16*)15:40, *s16-015*
 Voskian, Sahag, (*Wed s09*)09:30
 Vrana, Jiri, *s07-037*, *s07-038*, *s07-041*
 Vrabel, Heron, (*Thu 20*)09:30,
*(Fri 07)*09:30
 Vunder, Veiko, *s10-039*
 Vuorema, Anne, (*Thu 07*)14:00
 Vyskocil, Vlastimil, (*Mon s03*)17:20,
s03-055
 Vystavel, Tomas, *s06-032*

W

- Wackerl, Jürgen, *s07-135*
 Wadas, Anna, (*Thu 10*)16:00, *s15-024*
 Wadas, Artur, *s13-004*
 Wadayama, Toshimasa, *s02-013*
 Wagemaker, Marnix, (*Thu 12*)18:20,
s06-016, *s06-071*, *s06-139*
 Wagener, Philipp, *s10-008*
 Wagener, Victoria, *s14-017*
 Wagner, Guntram, (*Fri 13*)09:30
 Wagner, Maximilian, *s07-097*
 Wagner, Michal, *s03-012*
 Wagner, Norbert, *s06-089*, *s06-114*,
s18-020
 Wain, Andrew, (*Tue s16*)17:40,
*(Thu 07)*14:00
 Walcarius, Alain, (*Tue s01*)09:50,
*(Thu 02)*18:00, (*Fri 10*)11:30, *s02-033*,
s11-056
 Waldeck, David, (*Mon s03*)15:00
 Waldvogel, Siegfried, *s11-050*, *s11-052*,
s15-012, *s15-019*
 Walkowiak, Mariusz, *s06-128*, *s08-011*
 Wallace, Gordon, (*Tue s08*)17:40
 Walsh, Darren A., *s08-018*
 Walsh, Frank C., *s20-058*
 Walus, Sylwia, (*Fri 06*)10:50
 Wan, Li-Jun, *s07-079*
 Wang, Bin, *s02-075*
 Wang, Chao-hong, *s08-030*
 Wang, Chen, (*Fri 02*)09:50
 Wang, Chieh-Jen, *s04-024*
 Wang, Denjun, (*Mon s01*)17:20
 Wang, Fuhui, (*Mon s13*)18:00
 Wang, George, *s11-046*
 Wang, Guanxiang, *s07-059*
 Wang, Guiling, *s02-062*, *s02-073*, *s02-075*,
s08-024
 Wang, Hai-Peng, *s13-025*
 Wang, Hancun, (*Thu 07*)15:40
 Wang, Hsiao-Keng, (*Fri 13*)10:50
 Wang, Jiangwei, *s13-018*
 Wang, Jiazhao, *s06-086*
 Wang, Joseph, *s01-040*, *s03-060*
 Wang, Kai, *s08-031*, *s20-037*, *s20-038*

- Wang, Li, (*Mon s07*)18:20, (*Wed s16*)09:50, *s02-014*, *s03-011*, *s04-022*, *s06-073*
- Wang, Miao, (*Tue s09*)10:30
- Wang, Pei, *s07-134*
- Wang, Ping, (*Thu 07*)15:40
- Wang, Qi, *s06-022*
- Wang, Tanyuan, *s02-005*
- Wang, Tao, *s07-133*, *s15-031*
- Wang, Xiang, *s16-046*
- Wang, Xingyi, (*Thu 18*)16:40
- Wang, Xinxin, *s20-038*
- Wang, Ya Hui, (*Fri 13*)10:10
- Wang, Yonggang, *s07-046*
- Wang, Youling, *s07-052*
- Wang, Yu, (*Mon s16*)10:10
- Wang, Zhaohui, *s06-072*, *s08-022*
- Wang, Zhiyuan, *s10-023*
- Warakulwit, Chompunuch, (*Mon s01*)15:20
- Ward, Meryck, *s10-102*
- Waryo, Tesfaye, *s04-011*
- Wasinski, Krzysztof, *s06-128*, *s08-011*
- Wasner, Paul-Augustin, *s11-045*
- Watanabe, Masahiro, (*Thu 07*)14:40, (*Fri 07*)10:50
- Watanabe, Taku, (*Thu 06*)09:50
- Wattanakit, Chularat, (*Mon s01*)15:20
- Weber, Adam, (*Thu 07*)14:00, (*Thu 07*)14:20
- Weber, James, (*Thu 07*)14:00
- Weber, Norbert, *s06-129*, *s06-130*
- Webster, Richard, *s02-050*
- Wedlich, Klaus, *s06-028*
- Wei, Gang, *s08-043*
- Wei, Jie, (*Mon s16*)17:40
- Wei, Teng-Sing, *s07-042*
- Wei, Wei, *s06-024*
- Wei, Zidong, *s07-079*
- Weidenkaff, Anke, (*Thu 20*)17:40
- Weidlich, Claudia, *s07-047*
- Weier, Tom, *s06-129*, *s06-130*
- Weinberger, Stephan, (*Mon s07*)15:00, *s07-040*
- Weingarth, Daniel, (*Mon s08*)15:00, *s08-033*
- Weiser, Mathias, (*Thu 10*)18:00
- Welton, Tom, *s11-048*
- Weng, Yu-Ting, *s08-026*
- Werchmeister, Rebecka, *s03-027*
- West, Geoff, *s13-023*, *s16-025*
- Wezendonk, Tim, (*Mon s07*)17:40
- Whitby, Samuel A. I., *s02-006*
- Whitesides, George, (*Mon s21*)08:15
- Whittam, Joshua, *s08-042*
- Wickman, Bjorn, (*Tue s07*)17:20
- Widdershoven, Frans, (*Thu 02*)10:10
- Wiedemann, Martin, (*Mon s08*)17:20
- Wiednig, Christopher, *s07-123*
- Wiencke, Jan-Christian, (*Tue s11*)14:20
- Wierach, Peter, (*Mon s08*)17:20
- Wierzbiecka, Ewa, (*Fri 10*)09:50
- Wierzbinski, Emil, (*Mon s03*)15:00
- Wiese, Andreas, *s03-006*
- Wijenberg, Jacques, (*Mon s11*)10:10
- Wijeratne, Kosala, *s08-003*
- Wild, Mark, (*Fri 06*)10:50
- Wildlock, Mats, (*Mon s11*)10:30
- Wilkening, Martin, (*Mon s06*)09:30
- Wilkinson, David P., *s07-024*
- Williams, David, (*Thu 04*)09:30
- Williams, Federico, (*Wed s09*)10:10
- Williams, Rhodri, *s03-005*
- Willner, Itamar, (*Tue s03*)14:00
- Wills, Richard, *s06-126*, *s07-035*
- Wilson, George, (*Wed s03*)09:30
- Wilson, Lindsay, *s04-011*
- Wilson, Lucy, *s15-025*
- Winkler, Martin, (*Tue s03*)14:40, *s03-005*
- Winter, Martin, *s06-055*, *s06-056*, *s06-118*
- Wintrich, Daniela, *s20-043*
- Wippermann, Klaus, *s07-135*
- Witkowska Nery, Emilia, (*Mon s01*)09:50
- Witt, Julia, *s02-051*
- Wittich, Carolin, (*Tue s07*)15:20
- Wittmaier, Dennis, *s06-089*
- Wittstock, Gunther, (*Tue s01*)15:20, (*Thu 07*)10:10, (*Thu 20*)16:00, (*Thu 10*)18:20, *s02-051*, *s04-026*, *s06-074*, *s06-080*, *s06-081*, *s16-011*, *s17-004*
- Wöll, Christof, *s07-039*
- Wohlfahrt-Mehrens, Margret, (*Mon s08*)18:00
- Woi, Pei Meng, *s02-052*
- Wojciuk, Grzegorz, (*Mon s03*)16:00
- Wolfrum, Bernhard, (*Tue s03*)16:40
- Wollenberger, Ulla, *s03-045*, *s03-048*, *s03-049*
- Wonders, Ad H., *s16-010*
- Wong, Ademar, *s02-026*, *s02-027*
- Wongsawa, Thidarat, *s02-015*
- Woo, Tom, *s16-001*
- Wood, Vanessa, (*Thu 06*)14:00
- Wouters, Emlyn, *s20-036*
- Wreland Lindström, Rakel, *s06-075*
- Wu, Billy, (*Thu 12*)15:40
- Wu, Ching-Chou, *s04-024*
- Wu, Chumeng, *s07-136*
- Wu, Congping, *s07-094*
- Wu, Dan, (*Fri 13*)10:10
- Wu, De-Yin, *s18-008*
- Wu, Feixiang, (*Mon s06*)16:00
- Wu, Fengxia, *s04-012*
- Wu, Jianbo, *s06-023*, *s18-038*
- Wu, Jinping, *s06-030*, *s06-045*
- Wu, Li-chen, (*Thu 02*)17:40
- Wu, Longfei, *s18-037*, *s18-037*
- Wu, Minxian, (*Tue s14*)14:00
- Wu, Nae-Lih, (*Fri 06*)09:30, *s06-031*, *s06-044*, *s06-060*, *s08-026*
- Wu, Sheng-Hui, *s02-047*
- Wu, Ying-Syuan, *s11-026*, *s13-003*
- Würschum, Roland, *s07-123*, *s16-032*
- Wuttig, Anna, (*Tue s16*)14:40, (*Tue s16*)14:40, *s18-017*
- X**
- Xavier, André Felipe, (*Tue s15*)10:30
- Xia, Hai-Ping, *s07-133*, *s15-031*
- Xia, Kaisheng, *s06-030*
- Xia, Wei, *s07-089*
- Xia, Xing-Hua, (*Fri 02*)09:50
- Xia, Yong, *s04-012*
- Xia, Yongyao, (*Tue s06*)14:40
- Xiao, Jianping, (*Tue s16*)15:00
- Xiao, Jingjing, *s01-036*
- Xiao, Xianghui, (*Thu 07*)14:00
- Xiao, Xiaoyin, *s11-046*
- Xiao, Xinxin, (*Wed s03*)10:00
- Xiao, Yaoming, *s14-001*
- Xie, Anjian, *s02-080*, *s06-076*
- Xie, Jie, *s06-109*
- Xie, Zhaoxiong, *s07-137*
- Xiong, Lilong, *s06-020*
- Xu, Chao, *s06-072*
- Xu, Guobao, *s04-012*
- Xu, Hongyao, *s08-043*
- Xu, Huiying, *s01-036*
- Xu, Jing-Juan, *s01-028*
- Xu, Jingwen, *s03-062*
- Xu, Wei, (*Wed s02*)10:10
- Xu, Yaolin, *s06-107*
- Xu, Yixin, *s10-076*
- Xu, Youlong, *s06-020*
- Xu, Yue, *s08-023*
- Xu, Ziyang, *s04-009*
- Xue, Mianqi, (*Fri 18*)11:50
- Y**
- Yagci, Mehmet Can, *s06-094*
- Yagi, Ichizo, *s07-086*
- Yaguchi, Momo, (*Tue s16*)14:40, *s16-033*, *s18-017*
- Yakushenko, Alexey, (*Tue s03*)16:40
- Yamada, Norifumi, (*Wed s16*)10:10
- Yamagata, Masaki, (*Mon s08*)14:20
- Yamaguchi, Akira, (*Thu 18*)17:20
- Yamaguchi, Shinpei, *s06-059*
- Yamaguchi, Toshiaki, *s07-145*
- Yamamoto, Kazuhiro, *s01-006*
- Yamamoto, Kentaro, (*Fri 06*)11:50
- Yamamoto, Masahiro, *s20-005*
- Yamamoto, Tohru, *s07-103*
- Yamamoto, Yusuke, *s07-062*
- Yamashita, Yuya, (*Thu 07*)14:40
- Yan, Jia-Wei, (*Thu 16*)10:10
- Yan, Ning, (*Thu 07*)09:30
- Yan, Peng, *s08-024*
- Yan, Yushan, (*Fri 02*)11:10
- Yang, Cheng-Hsien, *s14-006*, *s14-014*
- Yang, Haesik, *s01-004*, *s01-009*, *s01-010*, *s01-011*, *s01-029*
- Yang, Jingshuai, *s10-076*
- Yang, Jinlong, *s02-032*
- Yang, Junghoon, *s06-061*
- Yang, Li, (*Thu 10*)17:20, *s10-041*
- Yang, Liuqing, (*Tue s06*)18:20, (*Fri 06*)09:50
- Yang, Quan-Hong, *s08-023*
- Yang, Sainan, *s08-024*
- Yang, Shu, *s10-024*
- Yang, Ting, *s06-132*
- Yang, Xuegeng, *s07-018*
- Yano, Hiroshi, (*Fri 07*)10:50
- Yano, Jun, *s10-028*
- Yanson, Alexei, (*Fri 13*)11:10
- Yao, Wei, (*Thu 06*)15:00, (*Fri 06*)09:50
- Yarman, Aysu, *s03-013*, *s03-045*
- Yaroslavtsev, Andrey, *s06-096*, *s06-104*
- Yasa, Ihsan, *s20-016*
- Yashina, Lada, *s16-043*
- Yashiro, Hitoshi, (*Fri 13*)11:30, *s10-007*
- Yasuda, Satoshi, *s13-024*, *s16-042*
- Yasumoto, Kenji, *s07-103*
- Yavuz, Abdalcabbar, (*Thu 10*)14:00
- Yavuz, Yusuf, *s11-018*
- Yaw, Chong Siang, (*Tue s14*)15:20
- Ye, Niya, *s10-076*

- Ye, Rongbin, (*Fri 13*)11:30, s06-077
 Ye, Shen, (*Tue s16*)14:40, s06-095, s16-040
 Yellinek, Shai, (*Thu 20*)15:40
 Yeo, Boon Siang, (*Thu 18*)17:40
 Yesilcimen-Akbas, Meltem, s06-098
 Yeung, Kan Kan, s16-034
 Yi, Jaeshin, s12-006, s12-008
 Yi, Jianglong, s20-037, s20-038
 Yi, T., (*Tue s06*)14:20
 Yi, Yaoyong, s20-037
 Yilmaz, Eda, s06-036, s06-084, s06-092, s06-094
 Yin, Jin, s10-003
 Yin, Xi, (*Tue s07*)14:20
 Yokoshima, Tokihiko, (*Thu 06*)16:40
 Yoon, Hyungook, s06-083
 Yoon, Hyunki, s20-020, s20-024, s20-025
 Yoon, Jeyong, s09-009
 Yoon, Songhun, s12-007, s12-011
 Yoshikawa, Kai, s15-023
 Yoshikawa, Masahiro, s07-103
 Yoshimoto, Nobuko, (*Mon s06*)18:00
 Yoshinari, Takahiro, (*Fri 06*)11:50
 You, Mina, s06-034
 Younadam, Nora, s08-032
 Younesi, Reza, (*Wed s06*)09:30
 Yu, Chuang, s06-139, s06-140
 Yu, Jihyun, s09-009
 Yu, Qiao, s06-095
 Yu, Song, s18-008
 Yu, Yang, (*Tue s13*)18:00
 Yu, Zhinan Landis, (*Mon s16*)09:30
 Yuan, Ding, (*Thu 02*)16:00, s02-016
 Yuan, Ning, s06-014
 Yuan, Tao, s02-076
 Yuan, Yu, s01-023
 Yuasa, Makoto, s03-063
 Yue-Jiao, Zhang, s16-045
 Yuen, Matthew Ming-Fai, s16-034
 Yufit, Vladimir, (*Thu 12*)15:40
 Yule, Lewis, s13-023
 Yum, Seungjib, s07-088
 Yun, Jeongse, s16-035
 Yun, Jeongsik, (*Thu 06*)17:40
 Yushin, Gleb, (*Mon s06*)16:00
 Yutthalekha, Thittaya, (*Mon s01*)15:20
- Z**
 Zacarias, Sonia, (*Mon s03*)10:30
 Zacharias, Robert, (*Thu 12*)17:20, s07-138
 Zafarani, Hamid Reza, (*Thu 02*)15:00
 Zafeiratou, Spyridon, (*Mon s07*)18:20, (*Wed s16*)09:50
 Zafeiropoulos, Georgios, s18-041
 Zagal, Jose H., s10-017, s15-038
 Zagoraiou, Eirini, s07-107
 Zaidi, Syed Zohaib Javaid, s20-058
 Zaino Jr., Lawrence, (*Wed s02*)10:10
 Zakaria, Siti N.A., s16-050
 Zakharova, Galina S., s03-008
 Zakroczymski, Tadeusz, s07-008
 Zaleski, Christopher, (*Tue s14*)16:00
 Zalibera, Michal, s15-042
 Zamburlini, Eleonora, (*Tue s07*)17:20
 Zamora, Hector, (*Mon s11*)14:40
 Zamora, Patricia, s05-009
 Zamudio-Torres, Ildefonso, s20-032
 Zan, Lingxing, s06-108, s16-036
 Zana, Alessandro, (*Tue s07*)10:30
 Zanata, Cinthia Rodrigues, s16-008
 Zandbergen, Henny, (*Tue s01*)14:40
 Zang, Dejin, s10-025, s10-057
 Zangheri, Martina, (*Fri 10*)11:50
 Zaroni, Maria Valnice Boldrin, s02-060, s18-007
 Zaraska, Leszek, (*Fri 10*)09:50, s10-051, s10-052
 Zarazúa, Isaac, s12-009
 Zausch, Jochen, (*Thu 12*)18:00
 Zeiger, Marco, (*Mon s08*)15:00, s08-033
 Zelenay, Piotr, (*Tue s07*)14:20
 Zelger, Christian, s07-048
 Zeng, Cheng-Chu, s15-013
 Zeng, Qiang, (*Thu 16*)10:10
 Zeng, Zhi-Cong, s16-046
 Zeng, Zhigang, s08-044
 Zenyuk, Iryna, (*Thu 07*)14:00
 Zeradhanin, Aleksandar, (*Mon s07*)17:00, s07-082, s07-111
 Zerbetto, Francesco, (*Thu 04*)14:40
 Zerbino, Jorge O., s13-006, s16-051
 Zerdoumi, Ridha, s10-053, s11-047
 Zeron, Paulino, s15-028
 Zhan, Dongping, (*Thu 02*)16:00
 Zhang, Bin-Wei, s10-006
 Zhang, Ce, (*Thu 06*)15:00, (*Fri 06*)09:50
 Zhang, Dengji, s10-076
 Zhang, Dewen, (*Mon s03*)17:40
 Zhang, Dongming, s02-062, s02-073, s02-075
 Zhang, Fangting, (*Mon s03*)17:40
 Zhang, Guang, (*Fri 06*)09:50
 Zhang, Hui, (*Thu 06*)15:00, (*Fri 06*)09:50
 Zhang, Huijie, (*Mon s01*)15:00
 Zhang, Jianrong, s03-061, s03-064
 Zhang, Jiaurui, (*Mon s16*)10:30
 Zhang, Jie, (*Fri 18*)11:50, s01-002, s01-008, s04-004, s13-018, s17-013, s18-021
 Zhang, Jifu, s13-007
 Zhang, Jinbao, (*Thu 10*)17:40
 Zhang, Jingdong, (*Mon s03*)09:30, s03-012, s03-014, s03-027, s10-019
 Zhang, Kaihuan, s02-056
 Zhang, Lin, s02-033, s11-056
 Zhang, Ling, s03-014
 Zhang, Minwei, (*Wed s02*)09:50, (*Fri 10*)11:50, s18-035
 Zhang, Mo, s18-029
 Zhang, Qinghong, s12-013
 Zhang, Ruirui, (*Thu 07*)15:40
 Zhang, Tao, (*Mon s13*)18:00, (*Mon s01*)18:00, s04-032
 Zhang, Teng, (*Fri 06*)10:50
 Zhang, Xiaolong, (*Mon s13*)10:10
 Zhang, Xin, s10-021
 Zhang, Xinxiang, (*Mon s03*)17:40
 Zhang, Xinyi, s14-005
 Zhang, Xiong, s08-031
 Zhang, Xueqing, s17-014
 Zhang, Yanjun, s01-017
 Zhang, Yi, (*Mon s13*)14:40
 Zhang, Ying, (*Fri 18*)11:50, s14-001
 Zhang, Yucheng, s14-008
 Zhang, Zhengwei, s06-020
 Zhao, Bo, s13-019
 Zhao, Chuan, s07-002
 Zhao, Fangyuan, (*Tue s03*)10:10
 Zhao, Lili, (*Tue s01*)17:40
 Zhao, Ran, (*Tue s09*)10:30
 Zhao, Shu-Feng, s18-021
 Zhao, Sijie, s06-114
 Zhao, Wei-Wei, s01-030
 Zhao, Xia, (*Mon s13*)10:30
 Zhao, Yan, (*Thu 12*)15:40
 Zhao, Yi-Ming, s03-039
 Zheludkevich, Mikhail L., (*Mon s13*)18:00, (*Tue s13*)17:20
 Zheng, Xiaoyu, s08-023
 Zheng, Xuan, (*Fri 13*)10:10
 Zheng, Yong-Li, (*Mon s16*)17:40
 Zhong, Jin-Hui, s16-046
 Zhong, Lijie, (*Tue s07*)14:40
 Zhou, Chenggang, s06-030, s06-045
 Zhou, Minghua, (*Tue s11*)18:00
 Zhou, Nan, s06-116
 Zhou, Yinglin, (*Mon s03*)17:40
 Zhou, Zhengyang, s06-014
 Zhou, Zhi-You, (*Thu 20*)17:20, s07-133, s15-031
 Zhu, Enhua, s04-014
 Zhu, Jun, s15-031
 Zhu, Junjie, s03-061, s03-064
 Zhu, Lei, (*Mon s17*)17:40
 Zhu, Lina, s01-036
 Zhu, Qingjun, s13-008
 Zhu, Tao, (*Tue s14*)15:20
 Zhu, Xinhua, s06-078
 Zhumaeu, Ulmas E., (*Wed s16*)10:30
 Zigah, Dodzi, (*Thu 10*)10:10, (*Thu 04*)17:20
 Ziganshina, Endzhe, s01-031
 Zimmermann, Roman-David, s11-045
 Zinovyeva, Veronika, (*Thu 20*)15:20
 Zitolo, Andrea, (*Tue s07*)14:00
 Ziyatdinova, Guzel, s01-031, s01-051
 Zlotea, Claudia, (*Thu 10*)14:40, s10-056
 Zollo, Giuseppe, s15-002
 Zornitta, Rafael, s09-008
 Zou, Jianli, s06-079
 Zou, Qianwen, (*Mon s08*)17:20
 Zou, Xiaodong, s06-014
 Zou, Zhigang, s07-094
 Zouni, Athina, s03-006
 Zozoulenko, Igor V., s08-003
 Zschornak, Matthias, (*Fri 06*)11:50
 Zukauskas, Airidas, s10-086
 Zúñiga, César, s10-017
 Zwierkowska, Elzbieta, s03-058



The International Society of Electrochemistry

The International Society of Electrochemistry (ISE) was founded in 1949 by leading European and American electrochemists to serve the growing needs of electrochemistry. At that time only a handful of scientists were members of the society – known as CITCE (Comité International de Thermodynamique et Cinétique Electrochimiques). Since then ISE has evolved and comprises now more than 3500 individual members, from 75 countries, and is organized in 44 Regional Sections. Both industrialised and developing countries from all five continents are represented. ISE is, therefore, a truly world-wide organisation. ISE is a non-profit-making organisation with its seat in Lausanne, Switzerland.

The International Society of Electrochemistry (ISE) is devoted to the advancement of electrochemical science and technology through the promotion of international contacts and the dissemination of scientific knowledge. For this ISE organises Annual and Topical Meetings which are held in different countries each year and which cover a wide range of current topics in fundamental and applied electrochemistry. The activities of ISE include the sponsoring of regional meetings, and of special meetings of limited participation devoted to particular subjects. A scientific journal, *Electrochimica Acta*, is edited by ISE and supplied to its members at a special rate. Individuals, non-profit organisations, industrial companies and learned societies may become members of ISE. The administration of ISE is done by an Executive Committee, periodically elected by all members. The Regional Representatives together with the Division Officers form the ISE Council which advises the Executive Committee. The scientific activities of ISE are grouped into Scientific Divisions. They are organised and co-ordinated by the Committee of Division Officers headed by the President Elect. Upon joining ISE each member indicates his/her divisional interests.

The history of the International Society of Electrochemistry (ISE) is described in a series of articles published in Volume 45 of *Electrochimica Acta* and available on the web site of the Society (<http://www.ise-online.org/geninfo/history.php>).

Why you should join ISE

ISE membership provides a number of advantages which can be summarized as follows:

- Individual members can get reduced subscription rates for the following journals:
 - Electrochimica Acta,
 - Journal of Electroanalytical Chemistry,
 - Electrochemistry Communications,
 - Bioelectrochemistry,
 - Journal of Power Sources,
 - Journal of Applied Electrochemistry,
 - Electrocatalysis,
 - Journal of Solid State Electrochemistry for personal use.There is also a **Discounted Package** available consisting of the Journal of Electroanalytical Chemistry, Electrochemistry Communications, and Bioelectrochemistry (online).
- Reduced registration fees at ISE Meetings
- Access to the "members restricted area" of the ISE website
- Access to the full membership directory with all members addresses

How to become an ISE member

Becoming an ISE member is simple: you will find a Membership Application Form on the Society web site (at the address: http://members.ise-online.org/members/new_members.php), which you can fill in and submit online. In the application form you will have to select up to three Divisions and indicate two sponsoring ISE members. Should it be difficult for you finding these sponsors, please write to the Executive Secretary of the Society Dr. M. Musiani, e-mail: m.musiani@ieni.cnr.it.

Membership fees

Individual yearly membership fees are 50 EUR for members above 30 years of age, and 15 EUR for members of age 30 or less and for Emeritus members.

ISE Organization



Executive Committee

The Executive Committee is entrusted with the management of the Society.

ISE Office

The ISE Office performs all administrative tasks related to the operation of the Society. It is located in Switzerland, and managed by an Executive Secretary.

The ISE Office serves as the primary contact for members and non-members.

Division Officers

The scientific activities of ISE are grouped into seven Scientific Divisions and a New Topics Committee. The divisions are headed by a Chairperson assisted by a Past Chair, a Chair Elect and two Vice Chairs. Their role is to promote and represent the scientific interests of the division and its members, for example through contributing to the organization of Annual, Topical and other Society meetings.

Regional Representatives

In each country or group of countries having fifteen members or more, a national or regional section of ISE may be formed. Each section has a Regional Representative.

Council

The ISE Council is an Advisory Body. The voting members of the Council consist of three Officers from each Division and all the Regional Representatives. All persons constituting the Council are elected by the members of the Society.

Scientific Meetings Committee

The Scientific Meetings Committee plans and oversees the organization and sponsorship of scientific meetings within the broad field of electrochemistry.

Fellows Nominating Committee

The Fellows Nominating Committee is a standing committee which proposes names to the Executive Committee for the title of ISE Fellow. It is also responsible for identifying candidates for honorary membership.

Publications Committee

The Publication Committee, a standing committee of ISE, acts as an advisory board to the Executive Committee on publication matters.



ISE Executive Committee

President

Christian Amatore, Paris, France (2015-2016)

Representation of ISE. Chairperson of Executive Committee, Council and General Assembly

President Elect

Philip N. Bartlett, Southampton (2015-2016)

Chairperson of Committee of Division Officers. Coordination of scientific program of future Annual Meetings, supervision of Division Officers' activities

Immediate Past President

Hasuck Kim, Seoul, Korea (2015-2016)

Chairperson of Executive Committee in the absence of the President

Vice Presidents

Plamen Atanassov, Albuquerque, NM, USA (2015-2017)

Responsible for Corporate and Corporate Sustaining Members

Katharina Krischer, München, Germany (2015-2017)

Responsible for Educational Activities in ISE

Tomokazu Matsue, Sendai, Japan (2016-2018)

Responsible for relations with other Societies

Yunny Meas, CIDETEQ, Querétaro, Mexico (2014-2016)

Responsible for Regional Sections

Secretary General

Manuela Rueda (2015-2017)

General tasks

Ensuring continuity and efficiency of scientific policy. Coordination of tasks of Vice Presidents.

Identification of new developments in electrochemistry and possible new scientific and nonscientific activities. Scientific matters not handled by the President or President Elect.

Tasks in collaboration with ISE Office

Ensuring that constitution, bylaws, guidelines, schedules etc. are observed. Preparation of Annual Reports.

Collection of information for newsletters and coordination of actions.

Annual and Topical ISE Meetings

Coordination of Meetings (location, time, topics). Representative of Executive Committee and advisor to Local Organising Committees for nonscientific matters (location, facilities, control of financial planning, schedule, publicity).

Treasurer

Bernard Tribollet, Paris, France (2014-2016)

Responsible for the administration and the management of the assets and property of the Society, preparation of budgets and financial reports, financial planning, investment policy, supervision of financial matters of Annual and Topical ISE Meetings.

Executive Secretary

Marco Musiani, Padova, Italy (2014-2018)

Responsible for maintaining the ISE calendar, assisting with organizing the business and financial arrangements for Annual and Topical Meetings, organising committee appointments, assisting the Secretary General with Society elections, recruiting new members, and co-ordinating Executive Committee meetings. Drafts ISE documents, acts as web page editor, maintains ISE archives and records, and serves as the contact person for members (particularly at ISE meetings).

Scientific Divisions of ISE



Division 1 – ANALYTICAL ELECTROCHEMISTRY

Experimental and theoretical aspects of the analytical process in which electrochemistry has a role, including sample collection / processing, separation, and species identification and quantitation.

Chair: F. Bedioui, Past Chair: A. Downard, Chair Elect: D. Mandler, Vice-Chairs: P. Baker and J. Pingarron

Division 2 – BIOELECTROCHEMISTRY

Aspects of electrochemistry and electroanalysis characterizing biological processes at the molecular level and relevant to the mechanisms of biological regulation of cells.

Chair: R. Bilewicz, Past Chair: A. Kuhn, Chair Elect: F. Lisdat, Vice-Chairs: D. Arrigan and E. Lojou

Division 3 – ELECTROCHEMICAL ENERGY CONVERSION AND STORAGE

Experimental and theoretical aspects of electrochemistry in which the goal is the interconversion of energy between different forms or the storage of energy, including the processes themselves and materials used for these purposes.

Chair: S. Passerini, Past Chair: D. Jones, Chair Elect: R. Kostecki, Vice-Chairs: F. Soavi and H. Uchida

Division 4 – ELECTROCHEMICAL MATERIALS SCIENCE

Aspects of materials science in which electrochemistry is part of the synthesis, processing, surface treatment, corrosion, characterization or modeling of new or existing materials, or in which electrochemistry is the user of such materials.

Chair: Chair: S. Brankovic, Past Chair: M. Ryan, Chair Elect: G. Zangari, Vice-Chairs: N. Birbilis and M. Vorotyntsev

Division 5 – ELECTROCHEMICAL PROCESS ENGINEERING AND TECHNOLOGY

Experimental and theoretical aspects and applications of electrochemistry in which engineering issues play a significant role, including scale-up and reactor design.

Chair: J. Peralta-Hernandez, Past Chair: F. Lapique, Chair Elect: K. Bouzek, Vice-Chairs: S. Mitsushima and M. Rodrigo

Division 6 – MOLECULAR ELECTROCHEMISTRY

Structural and mechanistic aspects of electrode processes of inorganic, metallorganic and organic substances; synthetic applications.

Chair: F. Paolucci, Past Chair: M. Goulart, Chair Elect: O. Buriez, Vice-Chairs: C. Frontana and G. Xu

Division 7 – PHYSICAL ELECTROCHEMISTRY

Experimental, theoretical and computational aspects of electrochemistry, alone or in conjunction with other methods, relevant to interfaces and conductive media; this shall include physicochemical nature, structure and dynamics from the molecular to the macroscopic level.

Chair: A. Russell, Past Chair: M. Eikerling, Chair Elect: A. Gewirth, Vice-Chairs: M. Arenz and Y. Chen

New Topics Committee

The New Topics Committee identifies interesting and relevant scientific and technological subjects not covered by the ISE Divisions. It has tasks similar to those of a Division, except that it may have several and changing technical priorities.

Chair: P. Unwin, Past Chair: T. Jacob, Chair-Elect: N.J. Tao



Regional Representatives

Argentina:	A.E. Bolzan	2015-2017	2nd term
Australia-NZealand:	C. Hogan	2015-2017	1st term
Austria:	B. Gollas	2016-2018	1st term
Belgium:	T. Breugelmanns	2016-2018	1st term
Brazil:	H. Varela	2015-2017	1st term
Bulgaria:	E. Slavcheva	2015-2017	1st term
Canada:	G. Jerkiewicz	2016-2018	2nd term
Caribbean Region:	J. Calderon	2014-2016	1st term
Chile:	R. Salazar	2016-2018	2nd term
China:	Yong-yao Xia	2016-2018	1st term
Croatia:	M. Kraljic-Rokovic	2015-2017	1st term
Czech Republic:	M. Fojta	2016-2018	1st term
Denmark:	Qingfeng Li	2015-2017	2nd term
Estonia:	E. Härk	2014-2016	1st term
Finland:	B. Wilson	2014-2016	1st term
France:	N. Pébère	2014-2016	2nd term
Germany:	H. Baltruschat	2015-2017	2nd term
Greece:	S. Neophytides	2016-2018	1st term
Hungary:	L. Peter	2014-2016	2nd term
India:	S.K. Aggarwal	2014-2016	1st term
Iran:	M.A.A. Ensafi	2016-2018	2nd term
Ireland:	J. Rohan	2016-2018	1st term
Israel:	N. Eliaz	2015-2017	1st term
Italy:	S. Cattarin	2016-2018	2nd term
Japan:	S. Kuwabata	2014-2016	1st term
Korea:	W. Shin	2016-2018	1st term
Lithuania:	R. Pauliukaite	2014-2016	1st term
Mexico:	C. Frontana	2015-2017	2nd term
Netherlands:	L. Rassaei	2016-2018	1st term
Norway:	V. Yartys	2016-2018	1st term
Poland:	M. Opallo	2016-2018	1st term
Portugal:	J.M. Palma Correia	2015-2017	2nd term
Romania:	M. Ungureanu	2015-2017	1st term
Russia:	M. Vorotyntsev	2016-2018	2nd term
Serbia:	A. Dekanski	2014-2016	1st term
South Africa:	P. Baker	2016-2018	1st term
Spain:	E. Herrero	2014-2016	1st term
Sweden:	R. Wreland Lindström	2016-2018	1st term
Switzerland:	P. Broekmann	2016-2018	1st term
Taiwan:	B.J. Hwang	2015-2017	1st term
Turkey:	M.S. Yazici	2014-2016	1st term
Ukraine:	O. Buket	2016-2018	1st term
United Kingdom:	T. Albrecht	2014-2016	2nd term
USA:	G. Botte	2015-2017	1st term



Corporate Sustaining Members

Corporate Sustaining Members are industrial and commercial (profit-making) organizations. As a Corporate Sustaining Member you can nominate one or two person(s) as your representative(s).

Corporate Sustaining representatives have the following advantages:

- One representative receives an online access to the ISE journal *Electrochimica Acta* without further charge.
- They can participate in Annual ISE Meetings at reduced registration fees.
- They are invited to co-operate with the divisions, to give proposals and advice on division symposia.
- They are informed about the activities of ISE and about Annual, Topical and Special ISE Meetings and division symposia on new developments in science and technology.
- They can be elected as Society officers

Advertising

- A list of the Corporate Sustaining Members is published regularly in *Electrochimica Acta* and on these web pages.

Annual Meeting

- Special sessions will be organised for electrochemical and electroanalytical instrumentation.
- You can contact regional groups via Regional Representatives.
- Business meeting places will be offered during Annual ISE Meetings for contacts between people from science and industry to discuss issues such as job recruiting, co-operation in applied research, announcement of research frameworks, negotiation of research contracts etc.

For further information please contact the ISE Office.

Corporate Sustaining Membership fee: 500 EURO

Corporate Members

Corporate Members are teaching institutions, non-profit-making research organizations and learned societies. As a Corporate Member you can nominate a person as your representative.

Corporate representatives have the following advantages:

- One representative receives an online access to the ISE journal *Electrochimica Acta* without further charge.
- They can participate in Annual ISE Meetings at reduced registration fees.
- They are invited to co-operate with the divisions, to give proposals and advice for division symposia.
- They are informed about the activities of ISE and about Annual and Special ISE Meetings and division symposia on new developments in science and technology.
- They can be elected as Society officers.

Corporate Membership fee: 300 EURO



ISE Honorary Members

Honorary Members are appointed by the Executive Committee, after consultation with the Council, primarily in recognition of their contribution to ISE. The total number at any time is limited to ten.

The first Honorary Member of ISE, appointed in the year 2003, was **Otmar Dossenbach**, Treasurer of the Society for 21 years (1980-2000) and Executive Secretary for 2 years (2001-2002).

Two new Honorary Members were appointed in the year 2004: **Roger Parsons** and **Sergio Trasatti**, former Presidents of the Society.

Three Honorary Members were appointed in the year 2005: **Ron Armstrong**, former Editor-in-Chief of *Electrochimica Acta* for 18 years, **Elton Cairns** and **Dieter Landolt**, former Presidents of the Society,

One Honorary Member was appointed in the year 2011: **Sharon Roscoe**, former Secretary General of the Society.

ISE Fellows

In recognition of their scientific or technical contributions to electrochemistry, the Society may confer on individual members the distinction of ISE Fellowship. Such ISE Fellows are appointed by the Executive Committee after consultation with the Council. The appointment does not carry with it automatic life-time ISE membership.

The present Fellows of ISE are:

H. Abruña	B.J. Hwang	R. Savinell
R. Adzic	G. Inzelt	E. Savinova
R. Alkire	K. Itaya	D. Schiffrin
Ph. Allongue	Y. Ito	W. Schmickler
C. Amatore	H. Ju	P. Schmuki
D. Aurbach	A. Jutand	F. Scholz
P. Bartlett	T. Kakiuchi	W. Schuhmann
R. J. Behm	A. Karyakin	B. Scrosati
A. Bond	H. Kim	A. Shukla
E. Cairns	M. Koper	P. Simon
A. Chen	A. Kornyshev	U. Stimming
C. Comninellis	C. Lamy	S. Sun
R. Compton	O. Lev	Z. Tian
S. Cosnier	J. Lipkowski	J. Ulstrup
P. Delahay	D. Macdonald	P. Unwin
C. Fan	D. Mandler	K. Uosaki
W.R. Fawcett	P. Marcus	C. Vayenas
J. Feliu	R.A. Marcus	A. Walcarius
C. Gabrielli	N. Markovic	Li-Jun Wan
E. Gileadi	J. McBreen	M. Watanabe
H. Girault	R. McCreery	A. Wieckowski
J. Gooding	R. Nichols	G. Wilson
L. Gorton	P. Novak	M. Winter
R. Guidelli	T. Osaka	J. Zagal
P. Hapiot	M. Osawa	J. Zhang
J. Heinze	S. Passerini	
R. Hillman	Z. Samec	



Society Awards

Electrochimica Acta Gold Medal

The Electrochimica Acta Gold Medal may be awarded every two years to the person judged to have made the most significant contribution to electrochemistry in recent years.

Frumkin Memorial Medal

The Frumkin Memorial Medal may be given once every two years. It recognises the outstanding contribution of a living individual over his/her life in the field of fundamental electrochemistry.

Katsumi Niki Prize for Bioelectrochemistry

The Katsumi Niki Prize for Bioelectrochemistry may be awarded every two years to a scientist who has made an important contribution to the field of bioelectrochemistry.

Bioelectrochemistry Prize of ISE Division 2

The Bioelectrochemistry Prize of ISE Division 2 may be awarded every two years to a scientist who has made an important contribution to the field of bioelectrochemistry.

Brian Conway Prize for Physical Electrochemistry

The Brian Conway Prize for Physical Electrochemistry may be awarded every two years, in recognition of the most successful achievements in Physical Electrochemistry in recent years.

Alexander Kuznetsov Prize for Theoretical Electrochemistry

The Kuznetsov Prize is awarded every two years to a living individual who has made groundbreaking contribution to the theory of electrochemical phenomena.

Jaroslav Heyrovsky Prize for Molecular Electrochemistry

The Jaroslav Heyrovsky Prize for Molecular Electrochemistry, supported by ISE Division 6, may be awarded annually to a scientist who has made an important contribution to the field of molecular electrochemistry in the last 5 years.

Tajima Prize

The Tajima Prize recognises the contributions made by younger electrochemists. Candidates must be less than 40 years old. An award may be made every year. The decision of the Award Committee will be based on published work.

ISE-Prize for Electrochemical Materials Science

The ISE-Prize for Electrochemical Materials Science is awarded annually to a young person for contributions in the field of electrochemical material science, including corrosion, electrodeposition and surface treatment.

Oronzio and Niccolò De Nora Foundation Young Author Prize

The Oronzio and Niccolò De Nora Foundation Young Author Prize may be awarded annually to a scientist of less than 30 years for the best paper published in the ISE society journal in the calendar year preceding the award.

ISE-Elsevier Prize for Experimental Electrochemistry

The ISE-Elsevier Prize for Experimental Electrochemistry may be awarded annually to a person who has made an important contribution to experimental electrochemistry.

ISE-Elsevier Prize for Green Electrochemistry

The ISE-Elsevier Prize for Green Electrochemistry may be awarded annually to a scientist of less than 35 years of age on January 1st of the year of the award, for recent application-oriented achievements in the field of environmental electrochemistry.

ISE-Elsevier Prize for Applied Electrochemistry

The ISE-Elsevier Prize for Applied Electrochemistry may be awarded annually to a scientist of less than 35 years of age on January 1st of the year of the award, for recent achievements in the field of applied electrochemistry.

Early Career Analytical Electrochemistry Prize of Division 1

The Early Career Analytical Electrochemistry Prize of ISE Division 1, sponsored by OrigaLys, may be awarded annually to a scientist of less than 35 years of age on January 1st of the year of the award in recognition of her/his recent achievements in Analytical Electrochemistry.

Electrochimica Acta and ISE Travel Award for Young Electrochemists

The Electrochimica Acta Travel Awards for Young Electrochemists are aimed at favouring the participation of young electrochemists in the ISE Annual Meetings. The applicants must be ISE members. They must have obtained their Ph.D. not earlier than 6 years before the deadline for applications.



ISE Sponsored Meeting Information

What is an ISE sponsored meeting?

You may have noticed that scientific meetings in the field of electrochemistry are often labelled “ISE sponsored Meeting”. What does this mean? In addition to organizing its own meetings, such as the Annual and Topical Meetings, ISE may sponsor other international scientific meetings in the area of electrochemistry. ISE sponsorship is intended to be a sign of quality for the meeting.

What are the requirements for ISE sponsorship?

ISE requires that the scientific quality of the meeting reaches the standard of its own meetings. It is desirable that the advisory board consists of ISE members, as far as possible. The meeting must be open to all ISE members.

Who decides?

The decision is normally taken by the officers of the ISE Division in whose field of interest the topic of the meeting lies. ISE Division Officers should be involved in the organisation of the meeting. The ISE Executive Committee decides on the sponsorship for meetings of general interest.

What are the obligations of the organizers?

The organizers have to publicise the ISE sponsorship in all the official documents related to the meeting (announcements, program, website etc.). At the meeting, a representative of ISE must be allowed to say a few words on behalf of the Society, and ISE must have the opportunity to advertise. After the meeting, the organizers should submit a short report to ISE to be published on the ISE website.

What do the organizers receive from ISE?

ISE publishes announcements and reports of ISE sponsored meetings on its website. The ISE Office can organize, free of charge, mailings to all, or a group of ISE members. In appropriate cases, there may be a special issue of *Electrochimica Acta* associated with these meetings. Decisions about special issues are made by the Editor-in-Chief.

What about money?

ISE sponsorship of a meeting does not necessarily include a financial contribution from ISE. The sponsoring Division(s) may use its funds to support such a meeting. The level of financial contribution will be determined by the Division(s), but a typical sum may be 500 Euros.

How to apply for ISE sponsorship?

If you would like to have the scientific meeting you are organizing sponsored by ISE, please send an e-mail to the ISE Office, at least one year in advance of the time of the meeting, and attach a completely filled in sponsor request form. This form can be found on the ISE website at: <http://ise-online.org/sponsmeet/info.php>. The decision will be taken by the Officers of the sponsoring Division(s), or by the Executive Committee, and the ISE Office will inform the applicant.

ISE Regional Student Meetings

Graduate Students who are members of ISE and intend to organize a Regional Student Meeting can apply for ISE financial support. Applications submitted by Graduate Students jointly with their supervisors or with other senior members of the staff of their university are also acceptable, but it is expected that the students will be engaged in the organizational aspects of the meeting as much as possible. Regional Student Meetings are typically one-day meetings involving graduate students active in the geographic area where the meeting takes place. The format of the meeting (oral presentations, posters, discussion sessions, other) is autonomously decided by the organizers who will be responsible for securing a venue and collecting registrations. No registration fee should be requested, if financially possible. When the Regional Student Meeting is associated to a larger ISE-sponsored meeting taking place in the same venue, the application must provide clear indication on the connections between the two events and must clearly describe the independent activities reserved to student participants. No later than one month after the meeting, the organizer(s) will send to the ISE Office a report on the event, including the names and the e-mail addresses of the participants. The student participants will be invited to apply for ISE membership. A report giving an overview of the meeting, accompanied by suitable pictures if available, will be posted on the ISE website under Student Activities.

Applications for ISE support must be sent by e-mail to the ISE Office, with a copy to the Regional Representative of the country where the meeting is organized, 3-12 months before the meeting date, using the application form. The local ISE Regional Representative, if requested, will assist the potential meeting organizer in the preparation of the application. Applications will be analyzed by a committee consisting of (i) ISE Immediate Past President (ii) ISE Secretary General, (iii) ISE Treasurer, (iv) ISE Vice President responsible for Educational Activity and (v) ISE Vice President responsible for Regional Sections. The response will be communicated to the applicant and to the relevant Regional Representative no later than 1 month after the application submission.

The maximum financial support will be 600 €; the expected use of the funds must be specified in the application. Co-sponsoring by other Societies and/or institutions is possible.

High Power Resolution Frequency

24 bits up to $\pm 100A!$



24
BIT
INSTRUMENT

High Power

- $\pm 100A$ at $\pm 12V$
- Bandwidth > 100kHz
- Rise time < 50 μs
- FRA/EIS: 10 μHz - 100kHz

High Resolution

- 24 bits
- max. $\pm 10V$, min. 0.15nV resolution
- 0.00001% of current range, min. 0.6aA resolution
- FRA/EIS: 10 μHz - 8MHz



Combined System Performance

System compliance	$\pm 100A / \pm 12V$
Resolution	24 bits
Modes	Potentiostat, Galvanostat, ZRA
4 Electrodes	WE, CE, RE, S
Applied potential range	max. $\pm 10V$, min. 0.02mV resolution
Current ranges	1pA - 100A, min. 0.6aA resolution
Current accuracy	0.2%
Potential ranges	$\pm 0.4mV$ to $\pm 10V$, min. 0.15nV resolution
Potential accuracy	0.2%, or 1mV
FRA/EIS	10 μHz to 8MHz
Electrometer: diff. RE/S	>1000GOhm//<8pF
Data acquisition rate	100kHz
Time resolution	min. 125ns



innovative solutions for electrochemical research

Ivium Technologies www.ivium.com info@ivium.com

Poster plan of poster presentation session 1 - Monday

Symposia: s1, s2, 5, s6, s11

Poster set-up Monday: 08:30-10:30

Poster Presentation: Monday, 22 August 2016: 11:00-12:30

Poster take-down Monday: 18:00-19:00

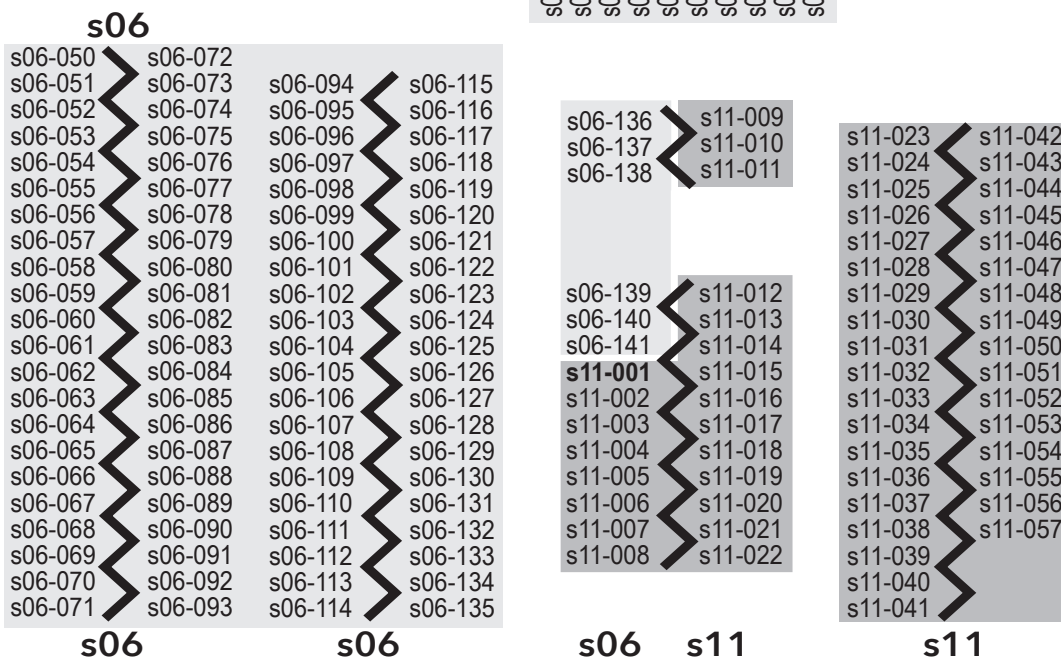
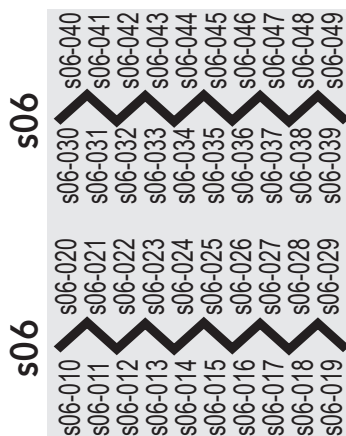
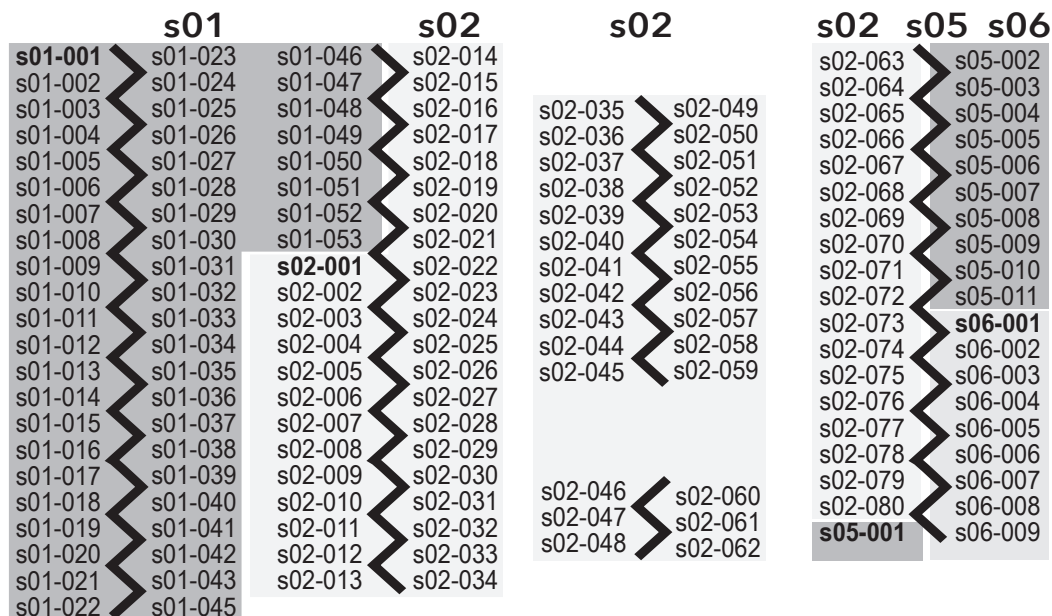

Poster plan of poster presentation session 2 - Tuesday

Symposia: s3, s4, s7, s10

Poster set-up Tuesday: 08:30-10:30

Poster Presentation: Tuesday, 23 August 2016: 11:00-12:30

Poster take-down Tuesday: 18:00-19:00

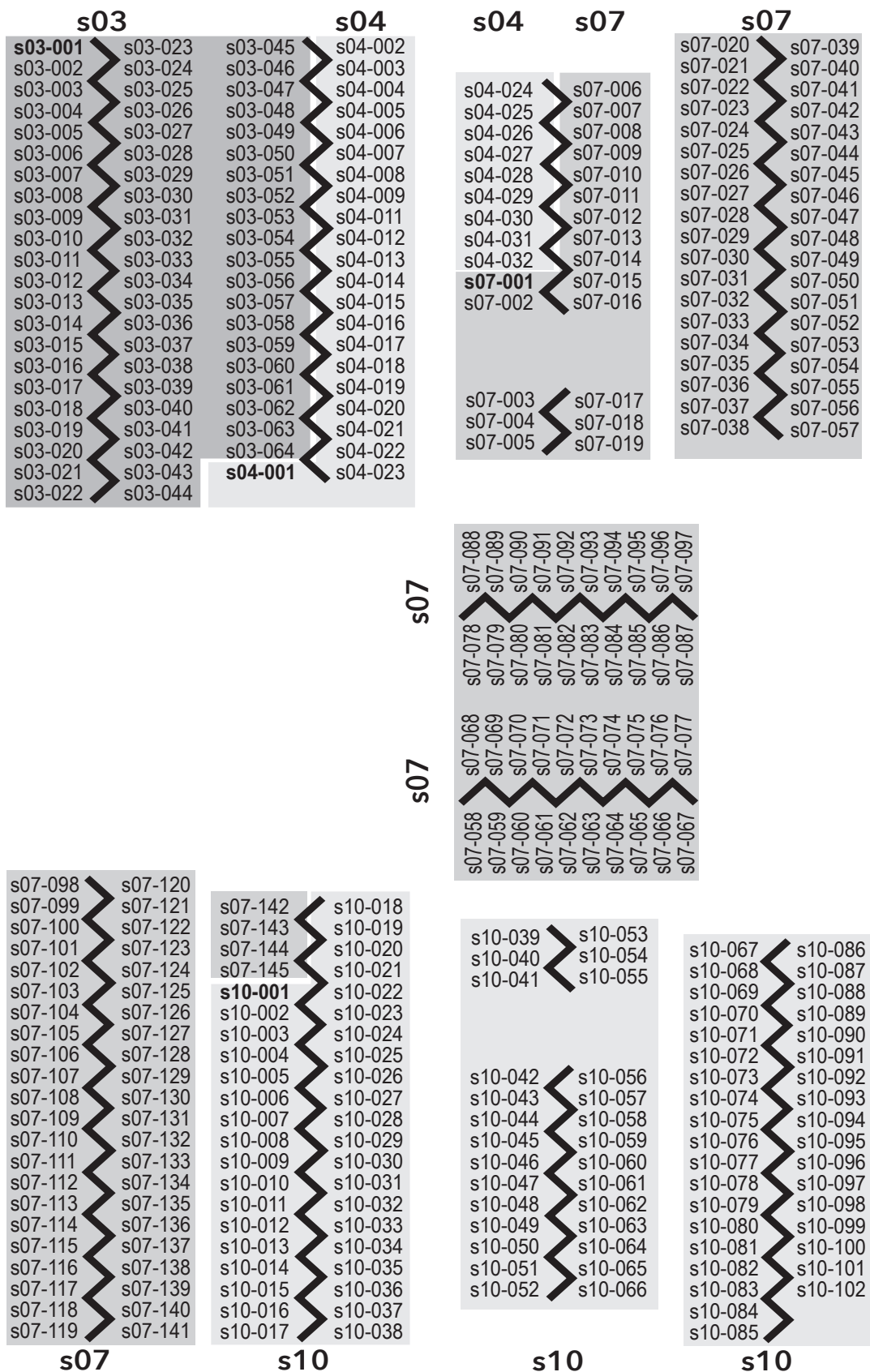

Poster plan of poster presentation session 3 - Wednesday

Symposia: s8, s9, s12, s13, s14, s15, s16, s17, s18, s20

Poster set-up Wednesday: 08:30-10:30

Poster Presentation: Wednesday, 24 August 2016: **11:00-12:30**

Poster take-down Thursday: 14:00-16:00

s08		s09	s12	s13	s14	s15	
s08-001	s08-024	s09-002	s09-023			s14-010	s15-012
s08-002	s08-025	s09-003	s12-001			s14-011	s15-013
s08-003	s08-026	s09-004	s12-002	s13-008	s13-023	s14-012	s15-014
s08-004	s08-027	s09-005	s12-003	s13-010	s13-024	s14-013	s15-015
s08-005	s08-028	s09-006	s12-004	s13-011	s13-025	s14-014	s15-016
s08-006	s08-029	s09-007	s12-005	s13-012	s13-026	s14-015	s15-017
s08-007	s08-030	s09-008	s12-006	s13-013	s13-027	s14-016	s15-018
s08-008	s08-031	s09-009	s12-007	s13-014	s14-001	s14-017	s15-019
s08-009	s08-032	s09-010	s12-008	s13-015	s14-002	s15-001	s15-020
s08-010	s08-033	s09-011	s12-009	s13-016	s14-003	s15-002	s15-021
s08-011	s08-034	s09-012	s12-010	s13-017	s14-004	s15-003	s15-022
s08-012	s08-035	s09-013	s12-011	s13-018	s14-005	s15-004	s15-023
s08-013	s08-036	s09-014	s12-012	s13-019	s14-006	s15-005	s15-024
s08-014	s08-037	s09-015	s12-013			s15-006	s15-025
s08-015	s08-038	s09-016	s13-001			s15-007	s15-026
s08-016	s08-039	s09-017	s13-002			s15-008	s15-027
s08-017	s08-040	s09-018	s13-003	s13-020	s14-007	s15-009	s15-028
s08-018	s08-041	s09-019	s13-004	s13-021	s14-008	s15-010	s15-029
s08-019	s08-042	s09-020	s13-005	s13-022	s14-009	s15-011	s15-030
s08-020	s08-043	s09-021	s13-006				
s08-022	s08-044	s09-022	s13-007				
s08-023	s09-001						

s16	
s16-009	s16-019
s16-010	s16-020
s16-011	s16-021
s16-012	s16-022
s16-013	s16-023
s16-014	s16-024
s16-015	s16-025
s16-016	s16-026
s16-017	s16-027
s16-018	s16-028

s15	s16
s15-031	s15-041
s15-032	s15-042
s15-033	s16-001
s15-034	s16-002
s15-035	s16-003
s15-036	s16-004
s15-037	s16-005
s15-038	s16-006
s15-039	s16-007
s15-040	s16-008

s16	s17	s18	s20	s20
s16-029	s16-051	s18-004	s18-025	s20-005
s16-030	s16-052	s18-005	s18-026	s20-006
s16-031	s16-053	s18-006	s18-027	s20-007
s16-032	s16-054	s18-007	s18-028	
s16-033	s16-055	s18-008	s18-029	
s16-034	s17-001	s18-009	s18-030	
s16-035	s17-002	s18-010	s18-031	
s16-036	s17-003	s18-011	s18-032	
s16-037	s17-004	s18-012	s18-033	s20-008
s16-038	s17-005	s18-013	s18-034	s20-009
s16-039	s17-006	s18-014	s18-035	s20-010
s16-040	s17-007	s18-015	s18-036	s20-011
s16-041	s17-008	s18-016	s18-037	s20-012
s16-042	s17-009	s18-017	s18-038	s20-013
s16-043	s17-010	s18-018	s18-039	s20-014
s16-044	s17-011	s18-019	s18-040	s20-015
s16-045	s17-012	s18-020	s18-041	s20-016
s16-046	s17-013	s18-021	s20-001	s20-017
s16-047	s17-014	s18-022	s20-002	s20-018
s16-048	s18-001	s18-023	s20-003	
s16-049	s18-002	s18-024	s20-004	
s16-050	s18-003			

Day-by-Day Week schedule

	SUNDAY	MONDAY	TUESDAY	WEDNESDAY	THURSDAY	FRIDAY
08:15 - 09:15		Plenary Lecture	Plenary Lecture	Plenary Lecture	Plenary Lecture	Plenary Lecture
09:30 - 09:50		Oral presentations	Oral presentations	Oral presentations	Oral presentations	Oral presentations
09:50 - 10:10						
10:10 - 10:30						
10:30 - 10:50					Coffee Break	Coffee Break
10:50 - 11:10		Coffee Break	Coffee Break	Coffee Break	11:10-12:10 General Assembly	Oral presentations
11:10 - 11:30		Poster Session	Poster Session	Poster Session		
11:30 - 11:50						
11:50 - 12:10					Lunch	Closing Ceremony
12:10 - 12:30		Lunch	Lunch			
12:40-13:40		Div.+RR Meetings	Council Meeting		12:40 - 13:40 Division Meetings	
		Lunch	Lunch		Lunch	
14:00 - 14:20	Tutorials	Oral presentations	Oral presentations	Excursions	Oral presentations	
14:20 - 14:40						
14:40 - 15:00						
15:00 - 15:20						
15:20 - 15:40						
15:40 - 16:00						
16:00 - 16:20						
16:20 - 16:40						Coffee Break
16:40 - 17:00						
17:20 - 17:40	Opening Ceremony	Oral presentations	Oral presentations		Oral presentations	
17:40 - 18:00						
18:00 - 18:20						
18:20 - 18:40						
18:40 - 19:00						
19:00 - 20:00	Welcome Reception	Reception				
				19:00 - 23:00	Banquet	