

disegno 8.2021



unione italiana disegno

8.2021

disegno

ISSN 2533-2899

english version



diségnó

8.2021

CONNECTING. DRAWING FOR WEAVING RELATIONSHIP

diségno



Biannual Journal of the UID Unione Italiana per il Disegno Scientific Society
n. 8/2021

<http://disegno.unioneitalianadisegno.it>

Editorial Director

Francesca Fatta, Presidente dell'Unione Italiana per il Disegno

Editor in Chief

Alberto Sdegno

Journal manager

Enrico Cicalò

Editorial board - scientific committee

Technical Scientific Committee of the Unione Italiana per il Disegno (UID)

Giuseppe Amoroso, Politecnico di Milano - Italia

Paolo Belardi, Università degli Studi di Perugia - Italia

Stefano Bertocci, Università degli Studi di Firenze - Italia

Mario Centofanti, Università degli Studi dell'Aquila - Italia

Enrico Cicalò, Università degli Studi di Sassari - Italia

Antonio Conte, Università degli Studi della Basilicata - Italia

Mario Docci, Sapienza Università di Roma - Italia

Edoardo Dotto, Università degli Studi di Catania - Italia

Maria Linda Falcidieno, Università degli Studi di Genova - Italia

Francesca Fatta, Università degli Studi Mediterranea di Reggio Calabria - Italia

Fabrizio Gay, Università luav di Venezia - Italia

Andrea Giordano, Università degli Studi di Padova - Italia

Elena Ippoliti, Sapienza Università di Roma - Italia

Francesco Maggio, Università degli Studi di Palermo - Italia

Anna Osello, Politecnico di Torino - Italia

Caterina Palestini, Università degli Studi "G. d'Annunzio" Chieti-Pescara - Italia

Lia M. Papa, Università degli Studi di Napoli "Federico II" - Italia

Rossella Salerno, Politecnico di Milano - Italia

Alberto Sdegno, Università degli Studi di Udine - Italia

Chiara Vernizzi, Università degli Studi di Parma - Italia

Ornella Zerlenga, Università degli Studi della Campania "Luigi Vanvitelli" - Italia

Members of foreign structures

Caroline Astrid Bruzelius, Duke University - USA

Glaucia Augusto Fonseca, Universidade Federal do Rio de Janeiro - Brasile

Pilar Chías Navarro, Universidad de Alcalá - Spagna

Frank Ching, University of Washington - USA

Livio De Luca, UMR CNRS/MCC MAP, Marseille - Francia

Roberto Ferraris, Universidad Nacional de Córdoba - Argentina

Ángela García Codoñer, Universitat Politècnica de València - Spagna

Pedro Antonio Janeiro, Universidade de Lisboa - Portogallo

Michael John Kirk Walsh, Nanyang Technological University - Singapore

Jacques Laubscher, Tshwane University of Technology - Sudafrica

Cornelie Leopold, Technische Universität Kaiserslautern - Germania

Carlos Montes Serrano, Universidad de Valladolid - Spagna

César Otero, Universidad de Cantabria - Spagna

Guillermo Peris Fajarnes, Universitat Politècnica de València - Spagna

José Antonio Franco Taboada, Universidade da Coruña - Spagna

Editorial board - coordination

Paolo Belardi, Enrico Cicalò, Francesca Fatta, Andrea Giordano, Elena Ippoliti, Francesco Maggio, Alberto Sdegno, Ornella Zerlenga

Editorial board - staff

Laura Carlevaris, Massimiliano Ciammaichella, Enrico Cicalò, Luigi Cocchiarella, Massimiliano Lo Turco, Giampiero Mele, Valeria Menchetelli, Barbara Messina, Cosimo Monteleone, Paola Puma, Paola Raffa, Veronica Riavis, Cettina Santagati, Alberto Sdegno (delegate of Editoria board – coordination)

Graphic design

Paolo Belardi, Enrica Bistagnino, Enrico Cicalò, Alessandra Cirafici

Editorial office

piazza Borghese 9, 00186 Roma
redazione.disegno@unioneitalianadisegno.it

Cover

Paul Klee, *Revolving house, 1921. Detail.*

The articles published have been subjected to double blind peer review, which entails selection by at least two international experts on specific topics. For Issue No. 8/2021, the evaluation of contributions has been entrusted to the following referees:

Fabrizio Agnello, Piero Albisinni, Marinella Arena, Marcello Balzani, Carlo Bianchini, Enrica Bistagnino, Stefano Brusaporci, Massimiliano Campi, Maria Grazia Cianci, Alessandra Cirafici, Francesco Di Paola, Tommaso Emler, Laura Farroni, Federica Maietti, Marco Muscogiuri, Pilar Chías Navarro, Sandro Parrinello, Maria Elisabetta Ruggiero, Salvatore Santuccio, Giovanna Spadafora, Roberta Spallone, Marco Vitali, Andrea Zerbi

Consultant for English translations Elena Migliorati.

Published in June 2021

ISSN 2533-2899



8.2021

diségno

7 *Francesca Fatta*

Editorial

9 *Agostino De Rosa*

Cover

So Distant, almost Close

22 *Mario Ridolfi*

Image

Love Knot

23 *Massimo Mariani*

Mario Ridolfi's *Love Knot*

CONNECTING. DRAWING FOR WEAVING RELATIONSHIP

29 *José María Gentil Baldrich*

Prometheus. Theory and Technique

A Reflection on the Spanish Expresión Gráfica Arquitectónica at the Zaragoza Congress "Pingui Minerva"

35 *Alessio Bortot*

The Sphere between Stereotomy and Cartography. From Stony Traits to the Representation of the Cosmos

47 *Giorgio Buratti*
Sara Conte
Valentina Marchetti
Michela Rossi

Weaving Ontology. Patterns of Textile Structures from the Knot to the Digital Lace

59 *Matteo Del Giudice*
Emmanuele Iacono

Algorithmic Approach for the Application of Graphic Standards in the BIM Environment

73 *Francesco Cervellini*

Metis. The Mutation of Form

Connecting. Notes and Exercises for a Theory of the Practice of *Disegno* of the Visual Form

87 *Pablo J. Juan-Gutiérrez*

Reversible Ideas, Irreversible Drawings.
Time as a Connector in Architectural Drawing

97 *Nicolas Turchi*

The Architecture of Spacetime: Memory as a Project

109 *Starlight Vattano*

Bodily Simultaneity in Avant-garde Art. Graphic Readings and Schemas

Mnemosyne. The Construction of Memory

- 123 Giuseppe Amoruso The Crown of Thorns of Notre-Dame de Paris, Mythological Representations of Memory
- 131 Salvatore Damiano Drawing Space in the Places of Myth: Luigi Moretti and Sicily
- 143 Giuseppe Antuono
Valeria Cera
Vincenzo Cirillo
Emanuela Lanzara *In-between Places. Multi-Scale Digital Hybridations of the Campania Caves&Quarries System*
- 157 Ilaria Trizio
Francesca Savini
Adriana Marra
Andrea Ruggieri The Virtual Tour as a Digital Tool for Linking the Disciplines of the Drawing and the Archaeology of Buildings
- 169 Fabrizio Agnello
Laura Barrale Reconnecting Past and Present with Old Photos. Reconstruction of the Church of the Stimmate in Palermo

Hermes. The story of Place and Things

- 183 Alessandra Cirafici Armed Architecture/Weapons of Architecture
- 197 Elena Ippoliti
Andrea Casale Representations of the City. The Diffuse Museum *The Esquilino Tales*
- 211 Graziano Mario Valenti
Alessandro Martinelli Aspects and Criticalities of the Fruition in Subjective of the Digital Space: the 'First Person View'
- 221 Giorgio Garzino
Maurizio Marco Bocconcino
Mariapaola Vozzola
Giada Mazzone From the Representation of Urban Vulnerability: the Drawing of Graphic Abacuses for the Project

RUBRICS

Readings/Rereadings

- 237 Massimiliano Ciammaichella Remember, You Are an Artist, Not a Scholar. Six Drawing Lessons by William Kentridge

Reviews

- 247 Ornella Zerlenga Massimiliano Ciammaichella (2021). *Scenografia e prospettiva nella Venezia del Cinquecento e Seicento. Premesse e sviluppi del teatro barocco*. Napoli: La scuola di Pitagora editrice
- 250 Francesco Maggio Elena Ippoliti (2020). *Il disegno per Gaetano Rapisardi. Progetti per Siracusa tra cronache e storia*. Milano: Franco Angeli
- 253 Andrea Giordano Veronica Riavis (2020). *La Chiesa di Sant'Ignazio a Gorizia tra architettura e pittura. Analisi geometrica e restituzioni per la rappresentazione tattile*. Trieste: EUT Edizioni Università di Trieste
- 256 Eduardo Carazo Lefort Roberta Spallone, Marco Vitali (2020). *Sistemi voltati complessi: geometria, disegno, costruzione*. Canterano (Roma): Aracne editrice
- 259 Enrica Bistagnino Alessandra Cirafici, Ornella Zerlenga (2020). *WordLikeSignMovie. Content switch*. Napoli: La scuola di Pitagora editrice

262 *Emanuela Chiavoni* Giorgia Aureli, Fabio Colonnese, Silvia Cutarelli (a cura di). (2020). *Intersezioni. Ricerche di Storia, Disegno e Restauro dell'Architettura*. Roma: Artemide edizioni

Events

267 *Cecilia Bolognesi* *Documentazione & Digitale 2020 Rome*. Knowledge and communication of Cultural Heritage

270 *Elena D'Angelo* Workshop 3D Modeling & BIM. *Digital Twin*

273 *Letizia Bollini* *Remediating Distances*. Presentation of IMG Journal 3/2020

276 *Alessandro Luigini* Second Annual Travelling Meeting of the *XYdigitale* Project and the *XY* Journal

281

The UID Library

285

UID Awards 2020

Editorial

Francesca Fatta

An introduction

Issue No. 8 of *diségno* represents an 'exception,' or rather a 'variant' of the program of events of the Unione Italiana per il Disegno; a necessary variant, in adaptation to the pandemic wave that has changed the life of the entire world for over a year.

The 42nd International UID Conference entitled *Connettere. Un disegno per annodare e tessere / Connecting. Drawing for weaving relationships*, which should have been held in mid-September 2020 on the Calabrian shores of the Messina Strait area, was postponed to the following year, same period. In substitution it was decided to organize a Study Day on the discipline in reference to the current hardships that the pandemic has imposed on us.

The Covid-19 pandemic will, therefore, leave a trace even in the life calendar of the UID, and on the uninterrupted sequence of the forty-one annual conferences that to this day have characterized the association's scientific structure. The Study Day took up the themes that had been previously established for the Conference, the Proceedings of which were published by Franco Angeli in open-access

reflecting, and in fact launching, a further focus, which then became the call of the conference to be held next September in Reggio Calabria: *Languages, Distances, Technologies*.

In the current issue, continuing the rhythm of our journal's even-numbered issues, we have thus decided to give an account of the results of the book of the *Proceedings*, inviting the authors of the papers evaluated in double peer review with the highest score to produce a long paper on the proposed topics.

An acknowledgement

Since March 2021, *diségno* has been indexed in Scopus. This is an important step forward for the growth of our still young publication, which aims to achieve full recognition as a Class A disciplinary scientific journal.

I would therefore like to thank both the Editorial Board and the Editorial Staff.

Issue No. 8

This issue, which we have defined as 'atypical' in light of its previously described characteristics, is intended to define a moment of reflection on the Proceedings of the conference *Connettere. Un disegno per annodare e tessere/Connecting. Drawing for weaving relationships*, and features the contributions of the Study Day held on 18 September 2020.

The *Cover* has been entrusted to Agostino De Rosa, with an *overture* that deals with the theme of 'connections' in relation to languages, distances and technologies, following a path that starting from the 'segno-di-segno' unfolds towards deep, intimate and archetypal considerations.

This is followed by a comment on the design of Mario Ridolfi's famous *Nodo d'amore (Love knot)*, chosen precisely for the intertwinings and weavings evoked by the subtitle 'drawing for weaving relationships'. The comment has been entrusted to one of his former students, Massimo Mariani, currently Councilor of the C.N.I. - Consiglio Nazionale degli Ingegneri d'Italia (National Council of Italian Engineers), responsible for Culture, who gives us a brief but intense testimonial of the Master's work.

The four Topics are introduced by José María Gentil Baldrich, professor emeritus at the Escuela Técnica Superior de Arquitectura de Sevilla, for the theme *Prometheus: theory and technique*; Franco Cervellini for the theme *Metis: the mutation of form*; Giuseppe Amoroso for the theme *Mnemosyne: the construction of memory*; and Alessandra Cirafici for the theme *Hermes: the story of places and things*. I am particularly pleased to present this sequence of keynotes that effectively 'connects' different generations of scholars, belonging to different contexts and backgrounds, yet all of

them decidedly linked to the various aspects of the discipline.

The columns that are a regular feature of all the issues of our journal present an overview of the vitality of Drawing and of its researchers.

Massimiliano Ciammaichella, in *Readings/Rereadings*, leads us to reflect on William Kentridge's *Six Drawing Lessons*.

This is followed by reviews of a selection of the monographs produced this past year, and of some of the events, seminars and congresses held in the last six months.

Starting with this issue, there is a new column which will be present in the even-numbered issues, concerning the prizes and awards that the UID presents, as is customary, during the activities of the annual conference: the UID Golden Awards, the "Gaspere De Fiore" Awards, and other prizes that may have been conferred.

Issue No. 9 and the future

Our editorial team is already working on Issue No. 9: a thematic issue, as is now customary, which will deal with the theme of *Visionary Drawing*. We are moving towards the renewal of UID's governing direction and bodies and a new structure for the Scientific Committee, Editorial Board and Editorial Staff. It is important to consider how, in these four years of life, *diségno* has grown thanks to the work and dedication of our entire scientific community, whose members, in their different capacities as authors, editors, reviewers, have believed in it.

The experience of the journal founded by Vito Cardone continues and will always be renewed, we are sure, at its very best.

CONNECTING. DRAWING FOR WEAVING RELATIONSHIP

Mnemosyne. The Construction of Memory

Documentation, Representation, Virtuality

Drawing Space in the Places of Myth: Luigi Moretti and Sicily

Salvatore Damiano

Abstract

How was architecture drawn in the 1930s? This is the starting question through which we want to set up a wider reflection on the architecture of that period, taking as reference a Sicilian project by Luigi Moretti: the Casa del Balilla in Messina, dating back to 1936. The initial analysis of the building's drawings is aimed at evaluating the expressive contents of drawing as a disciplinary instrument of architecture. But the fact that Luigi Moretti's first work in Sicily has never been built has also led to the elaboration of a further exegesis, consisting in the construction of a virtual three-dimensional model of the building: a process aimed at verifying the complexity of the forms transcending the unpredictability that pervades the final product of this logical-applicative consecutio of the tools of Science of Representation: digital images. Therefore, the reduction of the three-dimensional object (the model) into a two-dimensional entity (the image) poses both metalinguistic and projective questions: the model acts as a critical instrument that explains the reality imagined by Luigi Moretti, returning –through the heuristic force of images– all those syntactic, spatial, architectural, urban or even territorial tensions that the building would have possibly generated.

Keywords: Luigi Moretti, Messina, virtuality, 3D model, unbuilt architecture.

Introduction

History. This is the term we use to indicate –even more so in the scientific sphere– an investigation aimed at the reconstruction, not necessarily in chronological order, of circumstances, facts or events that are connected through a consequential development. History is therefore an action of rearrangement carried out mainly with the help of two types of testimony: one material or pseudo material, consisting of 'documents', which usually make up a particular archive, and the other, more specifically intangible, embodied by 'memories', which instead belong –in the strict sense of the term– to our mind. These are the two noble categories that will be used throughout this essay to reconstruct the history of a building in which the most striking feature is certainly

that it was never built, an event that would make it rise almost to the category of 'myth'.

Let us begin with the last of the two cases mentioned above: memories. Speaking of myth and turning our minds back in time, through an ideal journey of inner fascination, it was the titanid Mnemosyne –in Greek mythology– who handed down as a gift precisely these intellectual faculties, after discovering them and personifying them in herself [1]: in fact, according to Di-odoros Siculus, she (who was the daughter of Uranus and Gaea) is always credited with having unequivocally fixed a name for every object and every concept, thus giving mortals the possibility of understanding each other in their dialogues [2]. Vittorio Ugo asserted that myth

has a particularly distinctive trait, namely that of possessing a very high modelling power: unlike the rationality of mathematical models, however –Ugo continued– myth and its narration move through metaphysical and meta-rational models that take shape in the gods and in the representations of the various heroes as well as in their deeds and powers, although there remain other common characteristics between mathematics and myth, such as its all-encompassing nature, its persuasion to impose itself as an irrefutable truth, as a form that becomes a norm, as a value of mirroring, comparing or connecting different fields and contexts [Ugo 1994, p. 154]. Similarly, the notion of 'model' can be declined in architecture, as a form that scientifically expresses the qualities and properties of a work, also capable of delineating an exegetical truth, which, in turn, gives a picture of the ways and possibilities “of existence of an architectural space and its historical and critical relationships with theory” [Ugo 1994, p. 169]. Compared to the architectural artefact, the model constitutes, therefore, “a duplicate that denotes both its presence and absence” [Ugo 1996, p. 1]; moreover, on the concept of absence in architecture, we could say that modern digital three-dimensional models,

considered through perspective representations, can be considered as the 'locus' of the indissoluble connection between zero and infinity [Corbellini 2015, p. 88]. The model, therefore, is a “duplicate (or double) that unequivocally refers to the building, but through its immediacy and communicative evidence it bridges the spatial and temporal distance that exists between itself and its real physical counterpart” [Ugo 1996, p. 1]; nevertheless, in the present case under study the absence is of an absolute type, given that the building studied has never been built. But what about the other category, that of documents, which was mentioned at the beginning of the text? We certainly know that the document is an act that validates, certifies, provides us with proof. At the same time, it is implicitly a snapshot taken at a precise moment, and therefore belongs to history, and more precisely to an era. The task of a scholar capable of analyzing a document is to establish on the one hand its reliability and on the other its historicity, i.e. how it is critically placed in history and in what Vittorio Ugo defines as “epocality”: if the former is a strictly technical task, for the latter it is necessary to bring into play “the entire methodological, cultural and epistemological scope of the discipline” [Ugo 1994, p.

Fig. 1. Luigi Moretti, Casa del Balilla di Messina, graphic abstract of the study carried out and illustrated in this essay.



135]; the document is then subjected to in-depth analysis, during which it is compared, broken down, classified, possibly ordered in an archive, inserted into an “oriented system of knowledge” [Ugo 1994, p. 135], then processed to decode its message in order to create ‘our’ story, in addition to the one it tells us, to compare it with this one, producing, in other words, a critical-analytical hermeneusis, a model capable of interpreting “form in all its spatial, historical, material and qualitative determinations” [Ugo 1994, p. 135]. In this paper, from an eminently operative point of view, an attempt has been made to transpose the methodological instances expressed so far into an effective investigation, beginning with the analysis of some of the drawings selected from the complex of graphic-design plates of the building, or rather carrying out a sort of new cataloguing (or filing) of the plates considered most significant, which is an act that fixes the memory, orders it and makes it available [Ugo 1994, p. 115], in order to investigate the expressive contents of the graphic medium and of drawing understood as a disciplinary instrument proper to the architectural project: the final objective of this phase is to identify any innovative components both in the final graphic expressions and in the techniques and systems of representation through which the designer controls and verifies the semantic values of architecture. But the fact that the building analyzed has never been built has also led to the elaboration of a further exegesis, consisting in the orderly application of the tools of the science of representation, to which we wish to give a role of absolute centrality in the general dissertation: starting with drawing and survey, immaterial devices for knowledge, not used as a mere, neutral record of the architectural fact, but as critical-hermeneutical agents; the survey, in particular, understood as the “inverse of the project” [Ugo 1994, p. 116]; the graphic analysis as an investigation into the reasons for the syntactic-linguistic choices made by the architect [Clemente 2012, pp. 35-37]; and finally, the three-dimensional digital modelling, as the *sum* of the previous operations, on the effectiveness of which will depend a whole series of subsequent reflections, that is, the possibility of investigating, evaluating and verifying the essence of the spaces that were never born and their way of presenting themselves in succession. In short, it is a search for the connections that this latent architecture could have generated or catalyzed, whether they be visual, perceptive, dimensional or more properly spatial, architectural and urban.

Fig. 2. Luigi Moretti, Casa del Balilla in Messina, project drawings: a) First floor; b) Principal elevation; c) Cross-Sections; d) Central perspective (Archivio Centrale dello Stato, Archivio di Architetti e Ingegneri, Fondo Luigi Moretti, Opere e Progetti 1930-1975, segnature 1941/124/4, 1941/124/7, 1941/124/8 e 1941/124/11, by concession of the Ministry of Cultural Heritage and Activities and Tourism).

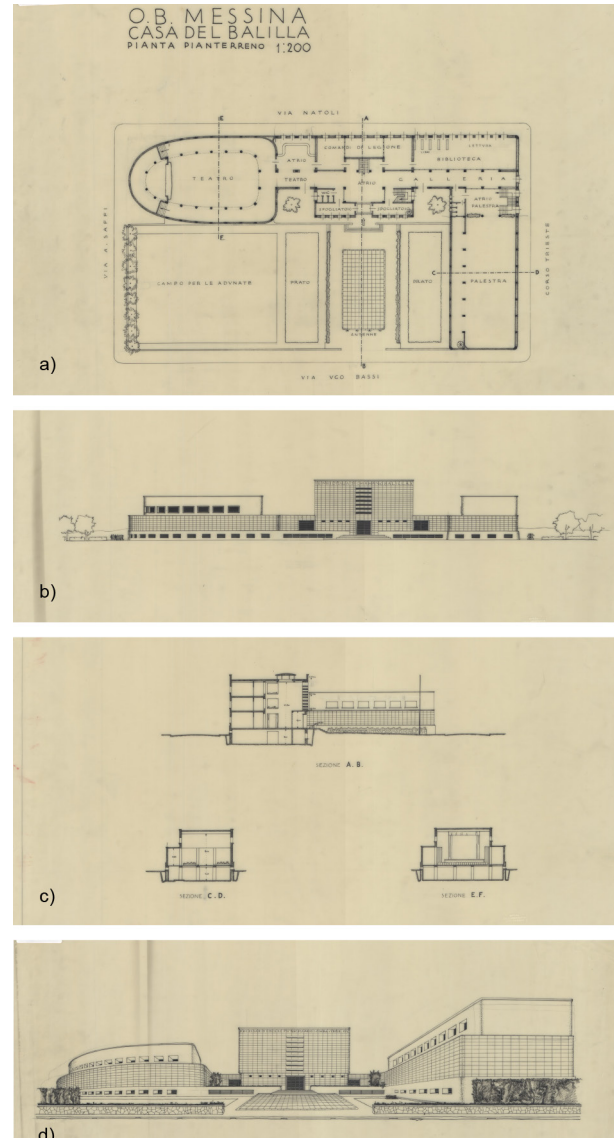

Fig. 3. a) Current orthophotographic view of Messina: the 'alle Moselle' district is highlighted; b) Planimetric photo-insertion of the building in the planned block (Basic image taken from Google Earth, software owned by Google LLC).



Luigi Moretti between myth and space.

The first Sicilian experience: the Casa del Balilla in Messina

The project we have chosen to examine in this essay is the Casa del Balilla [3] (or “Casa della Gioventù”) designed in 1936 for the Sicilian city of Messina by the architect Luigi Moretti [4]. The work, as already mentioned unbuilt, is amply documented by a rich and well-preserved collection of drawings, part of the fund dedicated to the designer, kept and protected by the *Archivio Centrale dello Stato* in Rome. These architectural graphs, all on glossy paper, include both pencil sketches and more definitive sketches in Indian ink. The drawings shown in this dissertation are the ground floor plan, an elevation, a table of cross-sections and a frontal perspective (fig. 2). Compared to the majority tendencies of those years, Moretti was no exception, ‘conforming’ to the use of that graphic technique that envisaged the use of modern ruling pens and of the even more recent and high-performance *graphos*, a method considered in some ways to be the transposition of the canons of rationalist architecture (expressive simplification, objectification of the building, dominion of function) into the drawing, which thus became a pure plastic-stereometric description, devoid of details, ornaments, effects [Santuccio 2003, p. 151] or anything that was considered superfluous, unlike what happened during the late season of eclecticism, modernism or floral styles, only a few decades earlier. However, it is necessary to remember that Luigi Moretti considered the ‘phenomenon’ of rationalist architecture as something insubstantial born exclusively from the “pure and simple projection of the graphic” [Diemoz 1937, p. 5] and therefore destined to extinguish rapidly and without particular regrets, so in a similar way, while welcoming the new techniques mentioned above, which “characterized the school of Le Corbusier” [Diemoz 1937, p. 5], he attempted to use them critically, using graphic expedients to make certain specific architectural solutions more evident, which he reiterated as if they were real stylistic elements in many of his other pre-war works. Let us see how this happened in the project drawings for the Casa del Balilla in Messina. If, for example, we observe the main elevation (fig. 2b), we will notice the presence of dots at the vertical limits of several of the volumes that make up the building as a whole, a graphic sign that indicates that these terminations are curved, a fact that is otherwise scarcely intelligible given that it is a

drawing in orthogonal projection. In the same drawing, one should note the dark backgrounds on the window and door frames (which clearly and immediately indicate the syntax generated by the relationship between empty and full spaces or between opaque and transparent parts) and the squaring on the intermediate paramental band, which effectively denotes the design indication of a possible covering in marble slabs. In order to understand the Roman architect's expressive intentions, it is sufficient to make a comparison with the greatest exponent of Italian rationalism, Giuseppe Terragni, who, in the various project drawings of the Casa del Fascio in Como, never represented the similar texture of stone slabs that would later cover the building in Como. In the iconic perspective drawing (fig. 2d), on the other hand, one immediately notices the incongruity regarding the number and size of the openings of the two lateral volumes, which turn out to be more and smaller than what is represented in the orthogonal projection drawings, probably to emphasize the expressive power of the curved volume on the left and the perspective depth of the gymnasium on the right. Lastly, as regards the representation of the context, Moretti seems to accept the canons of 'graphic rationalism' mentioned above without too much hesitation, since only in the elevations are the features of the landscape of the Strait of Messina or the Peloritan mountain range above the city just hinted at in the background, thus substantially and inexorably excluding it from the designer's graphic attention. Messina, however, was already one of the largest and most important urban towns in Sicily, given its enviable position as a real crossroads for commercial (and economic in general) traffic between the island and the rest of peninsular Italy. Its origins are undoubtedly very ancient and intimately connected with the mythological theme mentioned in the first paragraph: legend has it that the port of ancient Zankle (the primordial name for Messina) was generated by the fall of the scythe of the titan Kronos [5] into the sea during a battle with his father; still on the subject of connections, it should also be remembered that Kronos was the son of Uranus and Gaea, just like the goddess of memory Mnemosyne mentioned at the beginning of the text. In the recent history of Messina, however, the legend gave way to reality: in the last days of 1908 a terrible earthquake affected the city and the entire Strait area, causing tens of thousands of deaths and urban scenarios bordering on the apocalypse. Thirty years later, after Messina had been razed to the

Fig. 4. a) Basement (section plan at +1.80 m); b) First floor (section plan at +5.50 m); c) Second floor (section plan at +8.55 m).

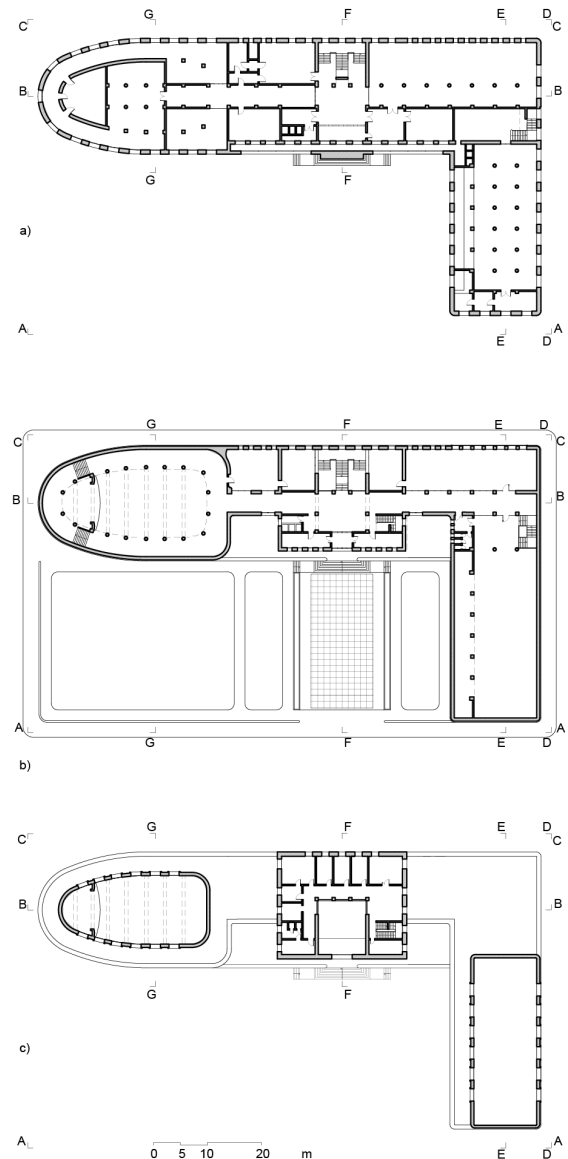

ground, it was still a building site, albeit nearing completion (in accordance with Luigi Borzi's reconstruction plan [6]), with the work of nationally renowned architects such as Marcello Piacentini, Giuseppe Samonà, Camillo Autore and Angiolo Mazzoni, not to mention other designers whose work was confined to participation in architectural

Fig. 5. a) Section AA; b) Perspective section AA; c) Section BB; d) Perspective section BB; e) Section CC; f) Perspective section CC.

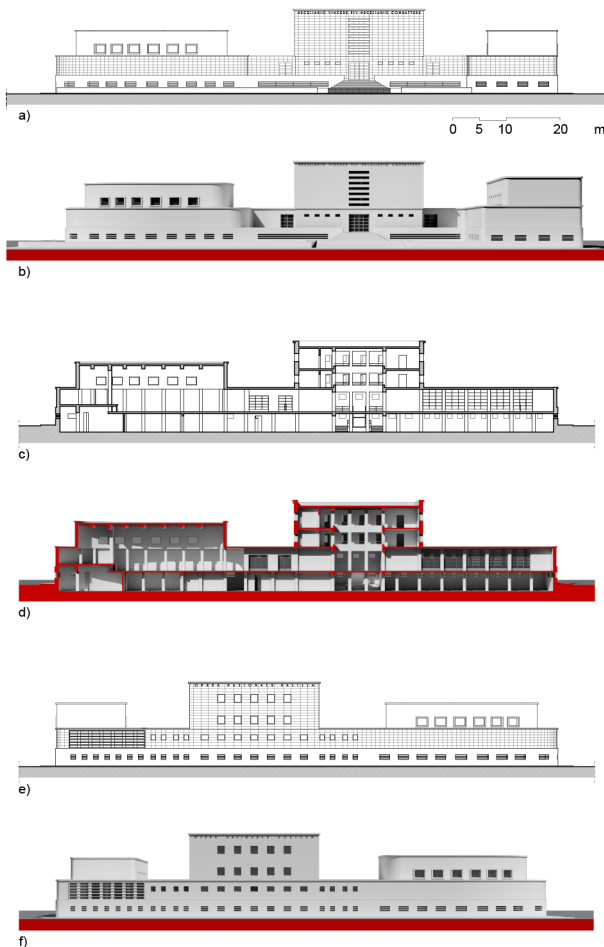

competitions, such as Adalberto Libera, Mario Ridolfi, Ernesto Bruno Lapadula and Gaetano Rapisardi [7]. Luigi Moretti's design for the local Casa del Balilla, which was to be built in the block between Via Giuseppe Natoli, Via Aurelio Saffi, Via Ugo Bassi and Via Trieste, in other words in the urban expansion already planned to the south of the old town by an unimplemented 19th-century plan and then further specified and implemented by the aforementioned post-earthquake Borzi Plan, falls in this modern vein [Mercadante 2009, p. 21]: the new neighborhood, called "alle Moselle" [Di Leo, Lo Curzio, pp. 11-16] (fig. 3a) because of the name of the plateau on which it was built, was conceived (by extending the road axes parallel to the sea of the existing city towards the south) according to a regular orthogonal layout, limiting the maximum height of the buildings to 10 m (later gradually derogated) [Mercadante 2009, p. 21; pp. 169-177]; expedients that gave this new part of the city a modern image, a characteristic that can still be perceived today throughout the city, in some ways in keeping with the Fascist regime's decision at the time to invest heavily in the Peloritani town devastated by the terrible earthquake, so that it could embody the much-vaunted dream of the «new city» [Barbera 2002, p. 78]. The same charge of modernity, however, did not physically manifest itself for Moretti and his Casa del Balilla, a building designed not to occupy the whole of the large rectangular block measuring 100 per 60 meters, on which it was destined, thanks to its L-shaped plan on the southern and eastern limits of the lot (fig. 3b). Here Moretti creates a large square in front of it, officially to be used for gatherings, but in fact functioning as a real 'churchyard', a defined urban space that in a propaganda perspective of the regime certainly precludes to the sacredness of one of the representative seats of the Fascist state, but that in reality constitutes – above all – the place delegated to the perspective perception of the building as a whole (fig. 11). The main façade of the Casa does not face the sea but opens towards the city, perhaps in Moretti's desire to prefer a connection that is more strongly urban than landscape; this thesis may be reinforced by the fact that the two directions delineated by the L-shaped plan form an ideal connection towards the city centre and its monuments (fig. 8b), such as the Duomo, its piazza, Palazzo Zanca (the city hall), the Palazzo di Giustizia, the Palazzo dell'Università or the Sacratio overlooking the strait, to name but a few. Of course, in the 1930s the area was not as densely urbanized

Fig. 6. a) Section DD; b) Perspective section DD; c) Section EE; d) Perspective section EE; e) Section FF; f) Perspective section FF; g) Section GG; h) Perspective section GG.

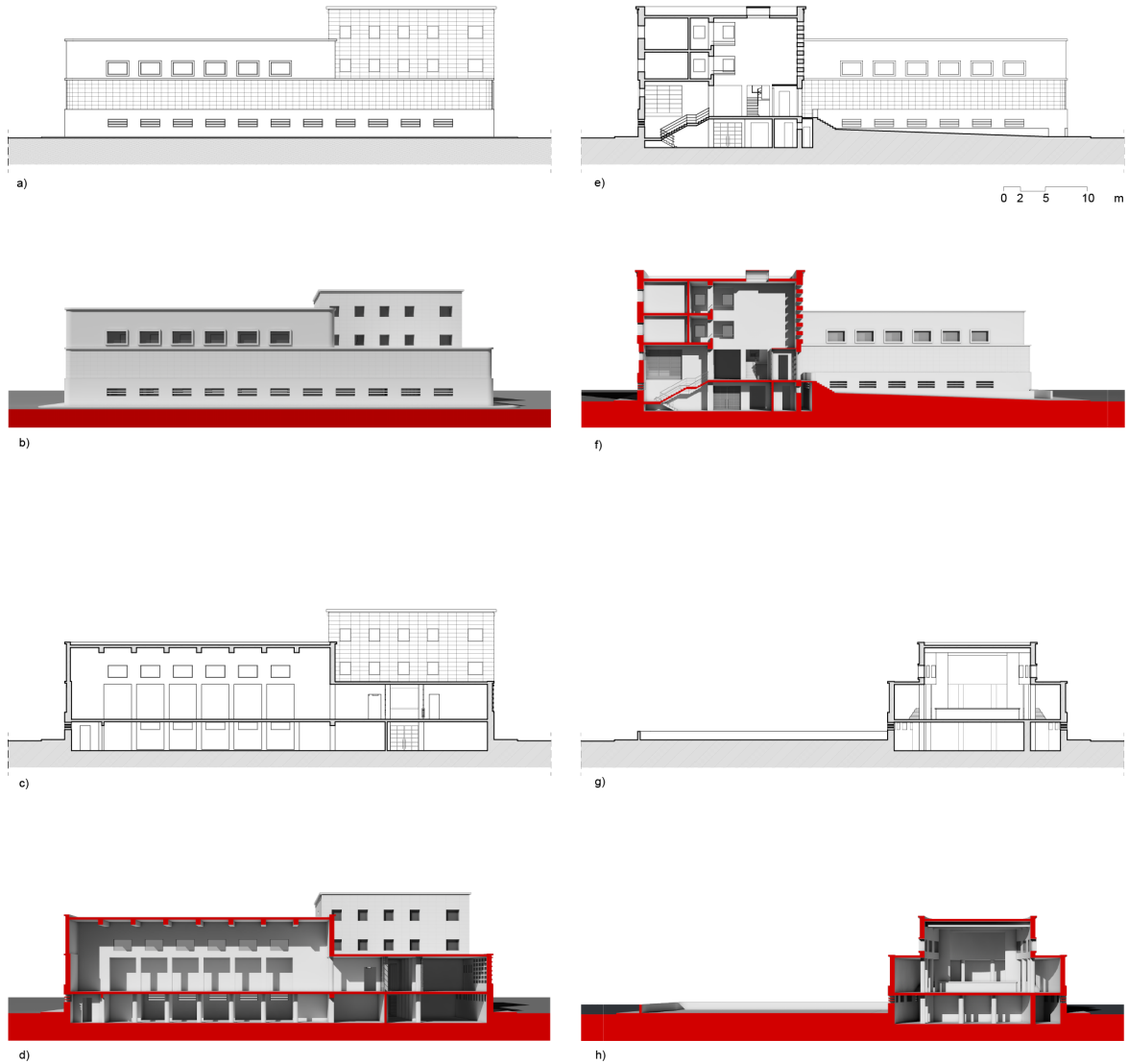
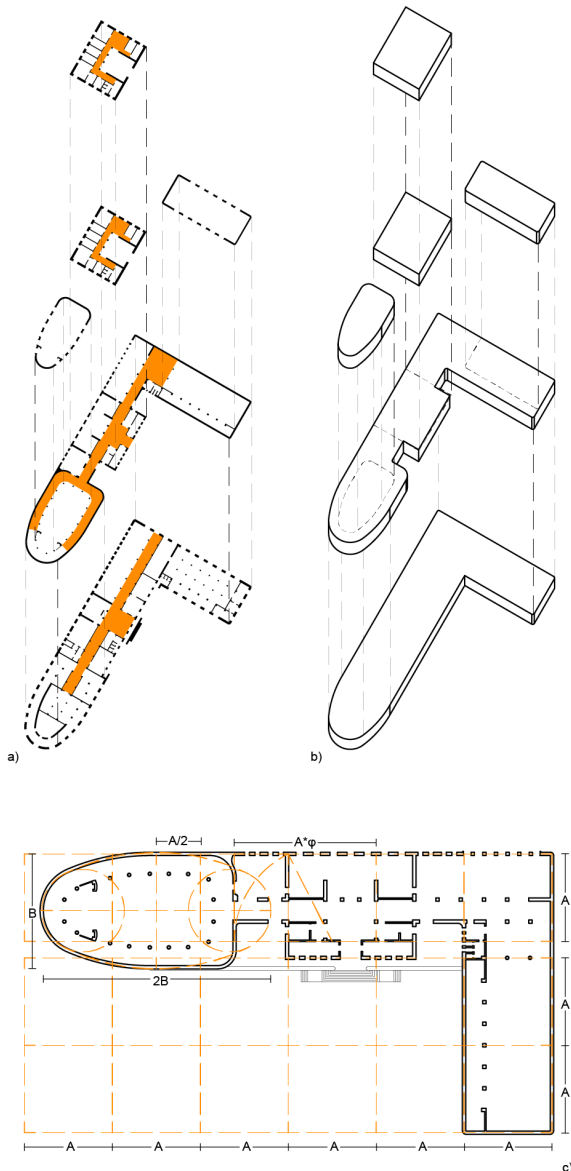
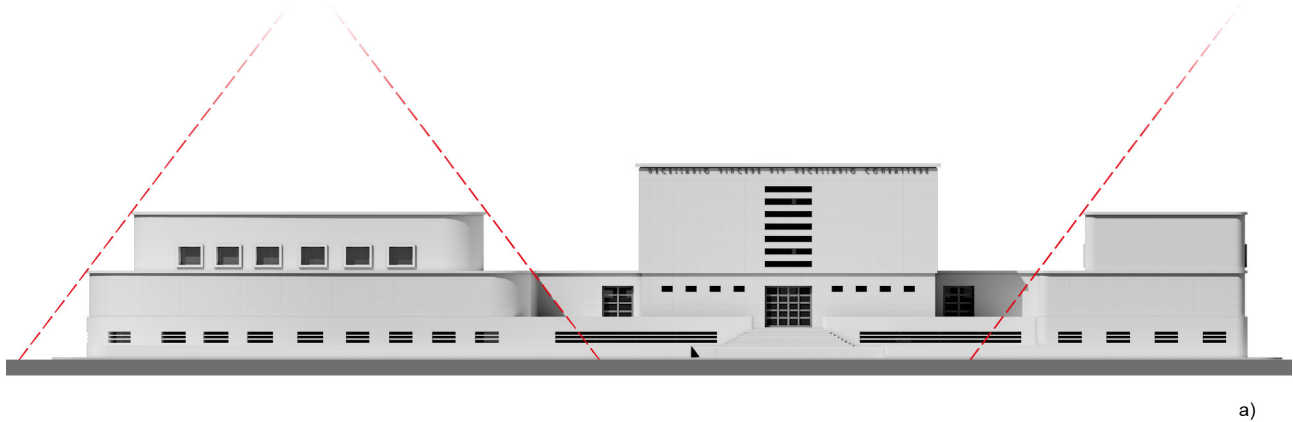

Fig. 7. a) Exploded axonometric projection with the identification of the service spaces; b) Exploded axonometric projection of the elevations; c) Regulatory layout governing the ground floor plan of the building.



as it is today, nor were there any buildings taller than 10 m, so it would have been possible to create a connection, not only visual but also physical, of flows, between the Casa del Balilla, as a possible urban backdrop, and the old town as a real hub, a reference point for the entire city. The exteriors of the building designed by Moretti present an accurate tectonic research (figs. 5, 6, 10 and 11): starting from the slightly tapered basement band that hides the basement spaces (fig. 4a), revealed by dosed openings with a prevalently horizontal axis, a continuous intermediate face rises (the raised ground floor of the building) covered perhaps with travertine slabs, (a technique already used by Moretti in the Accademia di Sclerma at the Foro Italico and in the Casa della G.I.L. in Trastevere, both in Rome), in which sharp edges give way to curved chamfers that perceptively favour the continuity of the visual and physical connection between the various surfaces of the façade in succession [8], softening their volumes and making them more compact [Docci, Chiavoni 2017, p. 26]; above, there is a third level consisting of the two emerging parts of the theatre and the gymnasium [Santuccio 1986, p. 68], which, positioned at opposite poles, present, compared to the intermediate band, an evident tapering as well as a traditional surface treatment –perhaps plaster– interspersed with large rectangular openings with projecting external frames and placed in sequence. All of these elements probably combine to create a stylistic feature that identifies and clearly distinguishes the two stereometries emerging from the remaining parts of the building: both do not actually embody a function linked to human use, but are conceived by Moretti as true collectors of natural light, capable of illuminating these large exceptional spaces, the theatre and gymnasium, which, compared to the other rooms in the building characterized by a ‘traditional’ intermediate floor, have a considerable free light, about 9 meters high (fig. 9). An exception to this is the large central prismatic volume (figs. 5, 6, 10, 11), which has the same slab treatment as the intermediate strip: this office block is slightly projecting from the ground floor, has sharp edges, solid walls with calibrated openings and is 15 m high. On the whole, the graphic-perceptual investigation carried out on the model of the building reveals that this compositional logic, organized as a succession of material-constructive layers tapering off as the height increases, almost giving rise to a ‘stepped’ construction, may have derived from Moretti’s desire to make the Casa di Messina an

Fig. 8. a) Frontal view of the model in orthogonal projection, study on the volumetric tapering and on the gradual connection between ground and sky; b) study of the possible urban connections between the building and the city (Basic image taken from Google Earth, software owned by Google LLC).



element of gradual connection between earth and sky (fig. 8a). The linguistic-figurative progress noted by Santuccio with respect to the previous Balilla buildings of the Roman architect concerns the rediscovered unity of the functional blocks (once clearly separated, as in the Accademia di Scherma in Rome or the Piacenza, Bitonto and Urbino buildings) [Santuccio 1986, p. 68], a characteristic that seems to reverberate clearly also in the architecture of the interiors: the entrance leads into a large, full-height space, illuminated by a skylight at the top and frontally by slit openings above the large entrance portal; this space (fig. 5d), reminiscent of the courtyards of Italian Renaissance palaces, is characterized by the presence of two superimposed loggias running along the three sides of the volume and serving as service areas for the executive rooms; these spaces are accessed by a small staircase to the right of the entrance, a fact that leads to the hypothesis that the project was not at an exactly definitive stage, also considering the scenographic importance that Moretti usually attributed to the stairs in this type of building [9]. This large central space is intersected by the pathway that crosses the building longitudinally (fig. 5d), which cannot

Fig. 9. Natural lighting: a) theatre, three-dimensional model view in orthogonal projection; b) gymnasium, internal model perspective.

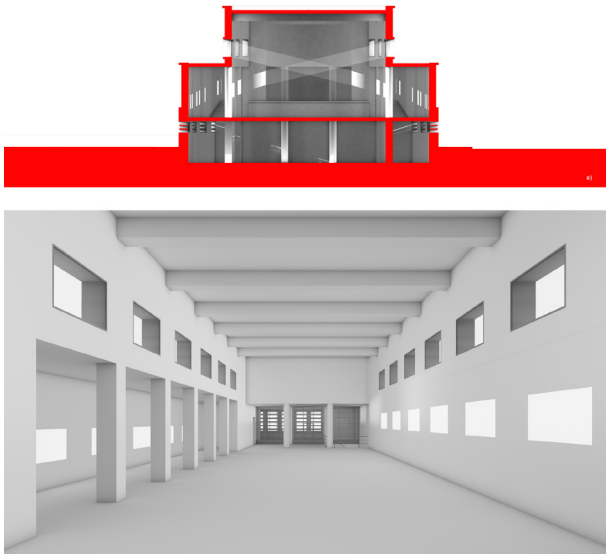

be defined as a simple 'corridor' as it is a true and proper ordered sequence of perspective views and alternation of spaces made of light, shadow and transparent planes, culminating in the two extreme poles already mentioned: to all effects a connective *promenade* between the gymnasium and the theatre, which has in the latter the perspective outcome of the spatial explosion (fig. 9); in addition, the tapering of the exteriors, described above, produces in the two large poles a hierarchy of spaces (which could be a veiled reference to Roman architecture, often used as a design reference by architects working under Fascism), in which the zones of passage or waiting are distinguished from the fundamental volume and ideally separated by an alignment of pillars (figs. 6d, 6h and 9), whether circular or square, all in a logic of synchronic connection inside-outside [Avella 2012]. The graphic analysis [10] carried out on the drawings reveals that the design of the space described above is controlled in the plan through a square mesh grid (15.90 m on a side) that governs the general composition and even before, through the sub-modules, the pitch of the framed load-bearing structure; the width of the two specular incidents placed on either side of the large central entrance prism respect precise golden proportions, while the organic form of the theatre derives from the construction of an octave oval (1:2, diapason) [11] in which the minor axis coincides with the centre line of the second column of squares (fig. 7c).

Conclusions

Luigi Moretti was an architect who practiced drawing in depth, understanding the potential of this medium (probably due to his acquaintance at the beginning of his career with Vincenzo Fasolo), which is not only purely expressive, but above all cognitive. Perhaps it is precisely for this reason that he made judicious use of it, showing an interest in the technical and executive innovations of the period but eschewing those extreme "aesthetics of the machine" paradigms that pervaded architectural graphic expression during the 1930s. In fact, the Roman architect enriched his drawings –albeit sparingly– in such a way as to highlight what he felt strongly characterized his projects. On the other hand, as regards the subsequent analytical level, it is easy to understand that the study of an architecture that has never been built can

really become a moment of in-depth knowledge of 'how' our places could have been: the search for those spatial connections that the city of Messina has had to give up due to the failure to build an architecture designed by an architect like Luigi Moretti has made it possible to verify the irreplaceability of Drawing as an operational tool in an analysis that evolves into a true exploratory action. Starting with bibliographic and archival sources, a cognitive process was initiated that penetrated the essence of the architectural phenomenon: the methodological application of the tools of the science of representation highlighted a design consistency given by a form that underlies and generates a complete space, understood in its broadest sense. From the initial graphic-perceptual

reflections on the *genius loci* [12] to the analysis of the regulatory layouts, we proceeded to select those facts, those elements and those connections considered significant for the structuring of the study model of an architecture that has remained confined to the project graphics only. This in-depth study of a project that has so far not been adequately treated by historiographic criticism adds an infinitesimal piece to our knowledge of the designer's general work and of 20th-century Italian architecture as a whole, revealing the almost spasmodic dedication that Luigi Moretti showed, even at the beginning of his career, in his search for a structured idea –from a mathematical, formal and perceptive point of view– of architectural space.

Fig. 10. Axonometric cross-section; central perspective.

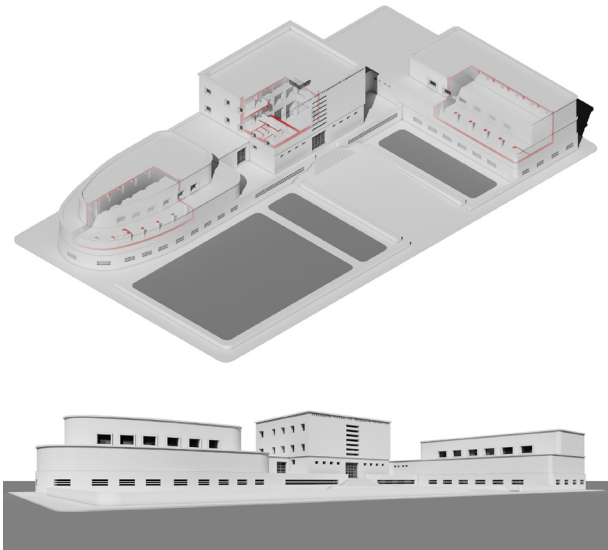
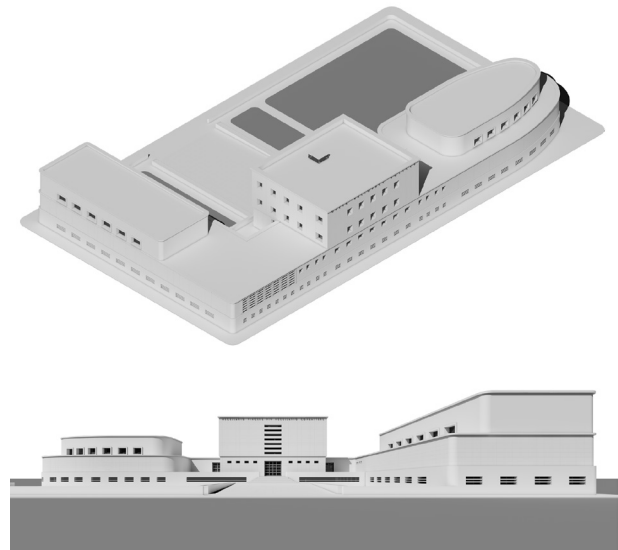

Fig. 11. Axonometry; accidental perspective.



Notes

[1] We refer to the description given by the scholar Diodorus Siculus in his work on universal history entitled *Bibliotheca historica*, for convenience consulted on the world wide web: <<https://www.theoi.com/Text/DiodorusSiculus5B.html>> (accessed 2020, January 10).

[2] *Ibidem*.

[3] In view of the aims of this paper, it is not appropriate to devote space to the history of the *Opera Nazionale Balilla* (an institution of the fascist regime for the physical education of young people) and to Luigi Moretti's role within it, aspects for which we refer to other much more exhaustive publications: Santuccio 2005; Capomolla, Mulazzani, Vittorini 2008.

[4] Capomolla, Mulazzani, Vittorini 2008, p. 246. For more detailed information on Luigi Moretti's life and work, see the various monographic publications dedicated to him, including Rostagni 2008. The Casa del Balilla in Messina was designed in collaboration with Cino Pennisi, a figure about whom there is no detailed information. The authors of the book cited at the beginning of this note and Daniela Fonti (in Bozzoni, Fonti, Muntoni 2012, p. 123) report a collaboration with Moretti that was not confined to the case of Messina discussed here. In addition, Cino Pennisi, also in 1936, designed the *Casa del Balilla* in San Severino Marche, in the Province of Macerata, which still exists today and is used as a conference hall, a building that in its stereometric configuration (and in part in its language) recalls the project for the Casa del Balilla in Messina: Capomolla, Mulazzani, Vittorini 2008, p. 248.

[5] In addition to the aforementioned Diodorus Siculus, for more in-depth information on the pre-Olympic divinity Kronos, please refer to any of the many translations of Hesiod's work currently on the market.

[6] For further information on the post-earthquake 1908 urban events in Messina, we recommend Di Leo, Lo Curzio 1985 and Mercadante 2009. These are two exhaustive texts on the subject from which this essay draws a great deal of information.

Author

Salvatore Damiano, Department of Architecture, University of Palermo, salvatore.damiano01@unipa.it

Reference List

Avella, F. (2012). *Esterno interno. L'immagine sincronica nel disegno di architettura*. Palermo: Edizioni Caracol.

Barbera, P. (2002). *Architettura in Sicilia tra le due guerre*. Palermo: Sellerio Editore.

Bozzoni, C., Fonti D., Muntoni, A. (a cura di). (2012). *Luigi Moretti. Architetto del Novecento*. Roma: Gangemi Editore.

Capomolla, R., Mulazzani, M., Vittorini, R. (2008). *Casa del Balilla. Architettura e fascismo*. Milano: Mondadori Electa.

Clemente, M. (2012). *Comporre e scomporre l'architettura: dall'analisi grafica al disegno di progetto*. Roma: Aracne Editrice.

Corbellini, G. (2015). *Exlibris. 16 parole chiave dell'architettura contemporanea*. Siracusa: LetteraVentidue.

Di Benedetto, G. (2018). *Antologia dell'architettura moderna in Sicilia*. Palermo: 40due Edizioni.

Di Leo, G.L., Lo Curzio, M. (1985). *Messina, una città ricostruita. Materiali per lo studio di una realtà urbana*. Bari: Edizioni Dedalo.

Diemoz, L. (1937). Propositi di artisti: Luigi Moretti Architetto, In *Quadrivio*, 13/12/1937, p. 5.

[7] For a complete overview of the debate and events surrounding architecture in the 1930s in Messina (briefly mentioned here) and throughout Sicily, see Barbera 2002 and Di Benedetto 2018.

[8] This detailed description of the tectonics of the facades is based on, and extends, the description in Santuccio 1986, p. 68.

[9] Just look at the spiral staircase in the Casa del Balilla in Trastevere or the small staircase designed, again by Moretti, for the Duce's gymnasium at the Foro Italo.

[10] Curiously enough, the person who codified and perfected the method of graphic analysis was Vincenzo Fasolo, an architect, engineer, lecturer in Rome on the subjects of drawing and architectural historian, whose assistant in the History and Styles of Architecture chair was Luigi Moretti [Rostagni 2008, p. 323] and probably a pupil.

[11] For an in-depth study of the design of harmonic ovals, see Dotto 2002. In this book, the 1:2 oval of the case analysed here is discussed on p. 42.

[12] For a comprehensive treatment of the concept of genius loci in the field of architecture, the reader is inevitably referred to Norberg-Schulz 1979.

Docci, M., Chiavoni, E. (2017). *Saper leggere l'architettura*. Roma-Bari: Editori Laterza.

Dotto, E. (2002). *Il disegno degli ovali armonici*. Catania: Le nove muse.

Mercadante, R. (2009). *Messina dopo il terremoto del 1908. La ricostruzione dal piano Borzi agli interventi fascisti*. Palermo: Edizioni Caracol.

Norberg-Schulz, C. (1979). *Genius loci. Paesaggio ambiente architettura*. Milano: Mondadori Electa.

Rostagni, C. (2008). *Luigi Moretti 1907-1973*. Milano: Mondadori Electa.

Santuccio, S. (a cura di). (1986). *Luigi Moretti*. Bologna: Zanichelli.

Santuccio, S. (a cura di). (2005). *Le case e il foro. L'architettura dell'ONB*. Firenze: Alinea.

Santuccio, S. (2003). Il disegno razionale. In C. Mezzetti (a cura di). *Il Disegno dell'architettura italiana nel XX secolo*, pp. 149-192. Roma: Edizioni Kappa.

Ugo, V. (1994). *Fondamenti della rappresentazione architettonica*. Bologna: Società Editrice Esculapio.

Ugo, V. (1996). Rappresentare. In *RectoVerso*, n. 7, p. 1.