

Monitoring and energy performance assessment of an advanced DEC HVAC system in Morocco

Marco Beccali^a, Pietro Finocchiaro^b, Vincenzo Gentile^c, Matteo Muscherà^d, Mario Motta^d

^a University of Palermo - Italy, ^b SolarInvent srl - Italy, ^c Polytechnic of Turin - Italy, ^d Polytechnic of Milan - Italy

Summary

This work addresses the energy performance of a solar Desiccant and Evaporative Cooling (DEC) system working with the freescoo technology. Freescoo is an innovative solar air conditioning concept for ventilation, cooling, dehumidification and heating of buildings in residential and tertiary sectors.

The monitoring of the system started in November 2016 and will continue until the end of 2017. Energy performances are evaluated according to the monitoring procedure for solar cooling systems developed by the Task 38 and 48 of the International Energy Agency experts.

The analysis based on monitoring data shows that, for typical operating conditions in cooling mode, the electricity saving in comparison to conventional HVAC systems can be over 70%.

1. Introduction

Within the agreement between Politecnico di Milano and AMEE (Agence Marocaine pour l'Efficacité Energétique), a solar cooling pilot plant had to be installed at a library in Marrakech. The aim was to develop, test and optimize a robust, low cost, low maintenance solar driven air-conditioning concept, suitable for Northern African climates. At the end of a call for tenders issued by Politecnico di Milano, freescoo by Solarinvent has been selected.

The building is a three-stage structure oriented NE-SW, and the last stage hosts the library. The library stage has a square shape. The roof is plane and presents a square-shaped skylight in the centre with a sloped roof. The skylight height is 1.30 m and his rooftop is 3.50 m above the plane level. The internal ambient is developed around the central space, corresponding to the square skylight. The ambient is composed of two different spaces. The first is assigned to the document shelves, while the other is designated to the hosts' seats. The net internal area is about 300 m². The internal ambient temperature is controlled by the pre-existing cooling system, made of four electrical split systems, with a global cooling power of about 18 kW. It has to be noted that only some split units operate properly causing frequent overheating during the summertime and insufficient heating during the wintertime.



Fig. 1: The library at AMEE

Table 1: Main building data

Description	Data
Internal area	300 m ²
Existing air distribution system	Plaster air ducts
Installed cooling power of split system	18 kW
Existing HVAC system	Ventilation AHU + split system
Occupation pattern	Library 9:00 -16:00

Global radiation on the horizontal on the site of Marrakech reaches 1100 W/m², whereas global solar irradiation in one year is about 1.9 MWh/m². Average temperatures vary from about 7°C to 35°C, peak temperature from 4°C to 43°C. Peak humidity ratio is about 16 g/kg in July.

2. Description of the system

The HVAC system is a freescoo AHU integrated with the solar collector; it has a maximum air flowrate of 1000 m³/h and supplies fresh air to a room of 400 m³. The max power needed is about 360 W. For driving the cooling process, about 2 litres of water per kWh of cooling energy are needed. In the wintertime, the system can provide also heating to the room when the sun shines and the required air change in the middle seasons.



Fig. 2: Picture of the freescoo system at AMEE

The freescoo concept is based on an innovative and patented DEC (Desiccant and Evaporative Cooling) open cycle technology: by using low enthalpy heat and water evaporation, Freescoo treats directly external hot and wet air to obtain a conditioned stream typically at 18-20°C and 50-60% of relative humidity, reducing drastically electrical demand in comparison to conventional HVAC systems based on vapor compression cycles.

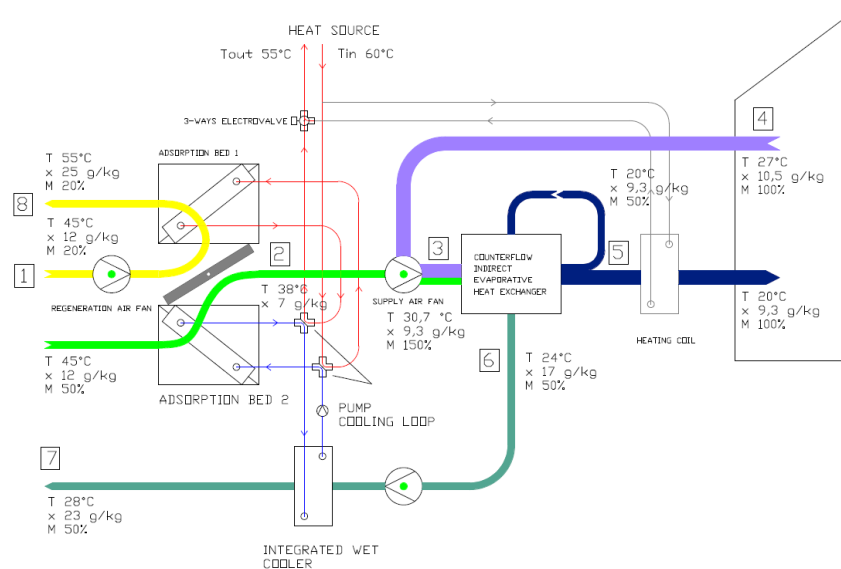

Fig. 3: Scheme of the operation in cooling mode

The innovative Freescoo DEC technology is based on two processes:

- Physical adsorption that reduces moisture content of external air up to the desired humidity rate by using two Cooled Package Beds of silica gel which are operated in a batch process. Each adsorption bed is realized with air to water heat exchanger filled with silica gel grains. The refrigerant used in the process is the water: so the adsorption material is cooled by water flowing through the tubes and a dry cooler is used to reject the adsorption heat generated by the desiccant bed operating in dehumidification mode. After hours of working the adsorption sorbent material reaches the maximum moisture content and it has to be regenerated by heating and drying the sorbent material with hot air.
- Evaporative cooling process takes advantage of advanced double stages indirect evaporative cooler which reduces air temperature up to the supply conditions without increasing the humidity content.

The cooling cycle is described here below. A flow rate of outside air (1) (moderate humidity and high temperature) is drawn through one of the adsorption beds. The moist air is simultaneously dehumidified (passing through the fins filled with silica gel grains) and cooled down (by the water flowing into the heat exchanger tubes). The coupling of dehumidification and cooling steps allows to increase the energy performance of the whole process in comparison to standard desiccant rotor based DEC cycles.

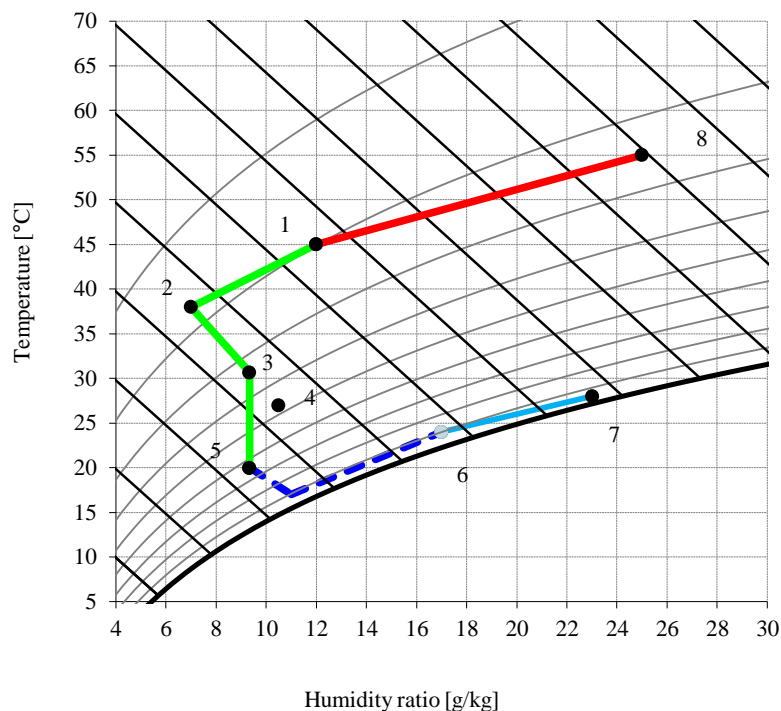

Fig. 4: Thermodynamics of the cooling cycle

Dehumidification process is carried out with a slight temperature decrease (2). Afterwards, dehumidified air is mixed with the return air extracted from the building (4), reaching the conditions of point (3). The mixed air enters the double-stages indirect evaporative cooler allowing to cool down the supply air without increasing its humidity reaching the supply conditions at point (5). In order to produce the cooling effect, a portion of the supply air is drawn to the secondary side (6). The air coming from the secondary side of the indirect evaporative heat exchanger, passes across the wet cooler and receives the adsorption heat caused by the dehumidification process in the adsorption bed (7). When the adsorbent material gets saturated with moisture, this must be reactivated by means of heat supply: outside air (1) is drawn into the sorption bed which must be regenerated and receives the moisture released by the desiccant which is now heated up by the hot water (8).

Two adsorbent beds are included in the Freescoo unit to ensure a continuous operation of the system: while the first one is working in order to dehumidify the air, the other one is regenerated using heat from the heat distribution system at temperature $> 55^{\circ}\text{C}$. A system of air dumpers provides the automatic commutation between the two adsorption beds to guarantee a continuous process.

Outside air is drawn into the counter-flow heat exchanger which is now used as heat recovery unit. Afterwards, the air is heated up in the heating coil which is connected with the heating source, reaching the supply conditions. Simultaneously, an equivalent portion of air is extracted from the building and used for pre-heating the outside air in the counter flow heat exchanger.

3. Results on the energy performance and discussion

In order to assess the energy consumption, an extended monitoring campaign has been performed during the 2017. For the heating mode data presented have been registered in January and February (59 days), whereas for cooling operation from May to September (159 days).

During the wintertime, daily operation hours varied according to the working hours of the solar collectors. In heating mode, being the system solar autonomous, it is operated only when temperature at the solar collectors exceeded 25°C. In summertime, the operation hours varied according to the decision of the users and varied from 10 to 24 hours a day. During the monitoring period, the building was occupied as normally.

Measurements of temperatures (accuracy $\pm 0.3^\circ\text{C}$) and humidity (accuracy $\pm 2.5\%$ of measured value), air velocity (at supply, return, adsorption beds), accuracy of $\pm (0.5 \text{ m/s} + 3\%$ of measured value), electricity consumption (accuracy $\pm 0.5\%$), solar radiation (2° call accord to ISO9060), and water flowrates (accuracy $\pm 3\%$) have been measured at inlet and outlet of main components. Data acquisition has been performed using the GPRS 2 platform from SENECA at 16-bit together with 4 x 8 input analogue modules and 1 digital DI module.

Energy performances have been evaluated according to the monitoring procedure for solar cooling systems developed by the Task 38 and 48 of the International Energy Agency experts.

In the following pages the behaviour of the system will be analysed, and diagrams and instantaneous and long-term energy performances will be presented.

Typical winter operation is depicted in Fig. 5,6,7,8: first two graphs are related to a day of February in which there's a continuous and abundant solar radiation; in Fig. 7 and 8, a day of January with a lower total solar radiation and a discontinuous behaviour is reported. The external temperature has an excursion of 10-15°C between the day and the night time in both cases, instead the building temperature has a quasi-flat behaviour.

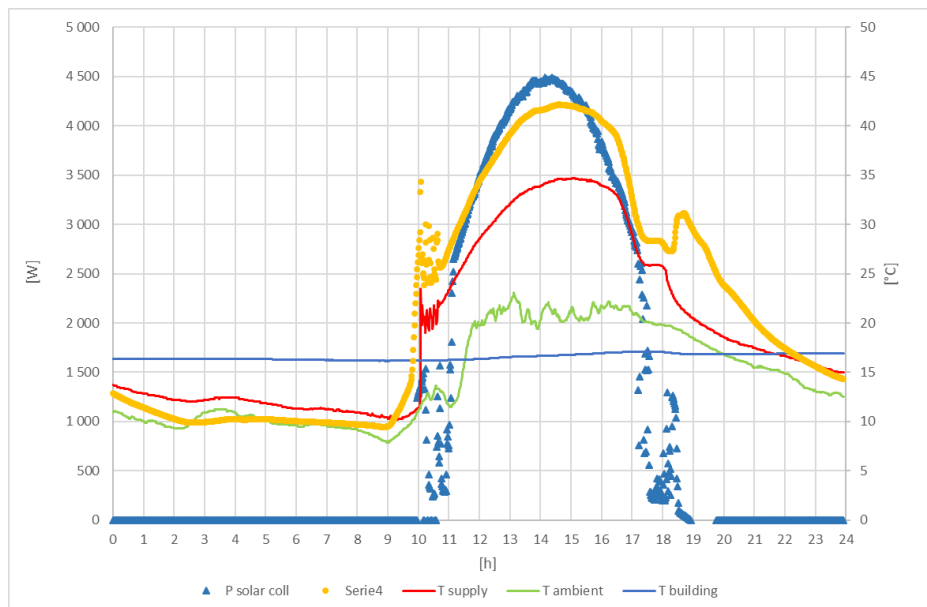

Fig. 5: Thermal performance of the AHU – Day 1, 03.02.2017

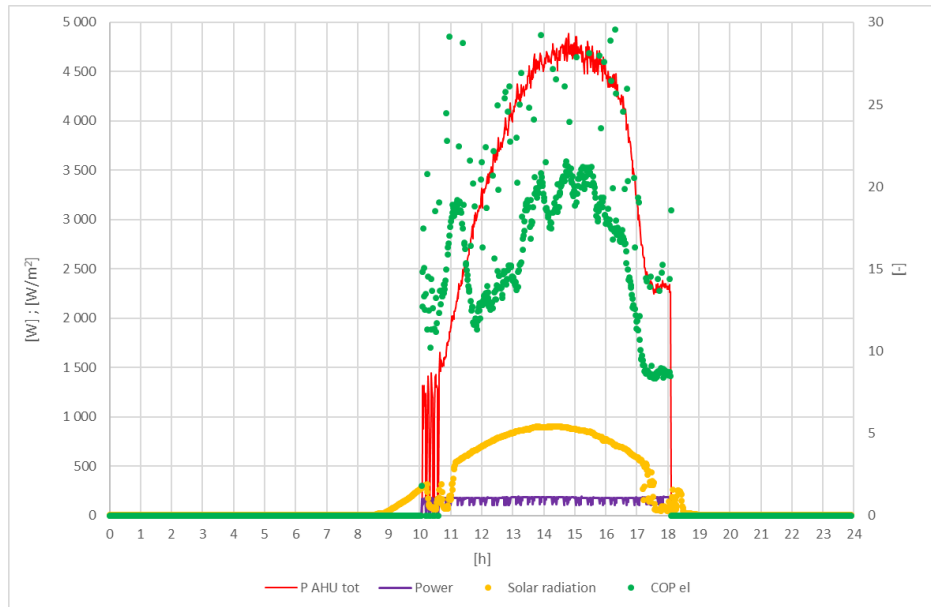

Fig. 6: Electrical performance of the AHU – Day 1, 03.02.2017

For the days considered, the supply temperature of the AHU ranges between 25 and 35°C, with the typical trend that follows the daily solar radiation. Evacuated solar collectors work quite efficiently, between 55-62 %, and the daily COP of the AHU during the winter operation ranged between 11-15. These values are strongly correlated to the total amount of solar radiation that influences directly the energy performances of the AHU. In fact, due to the malfunction of the internal split unit, the temperature of the building is always lower than the supply temperature, therefore the AHU works always at the maximum air flow rate with a constant electrical consumption. As a result, the working operation is quite similar during the winter season, between 6.5 and 8 hours per day. The higher incident solar radiation, the higher thermal power of the AHU, and consequently the higher values of the electrical COP.

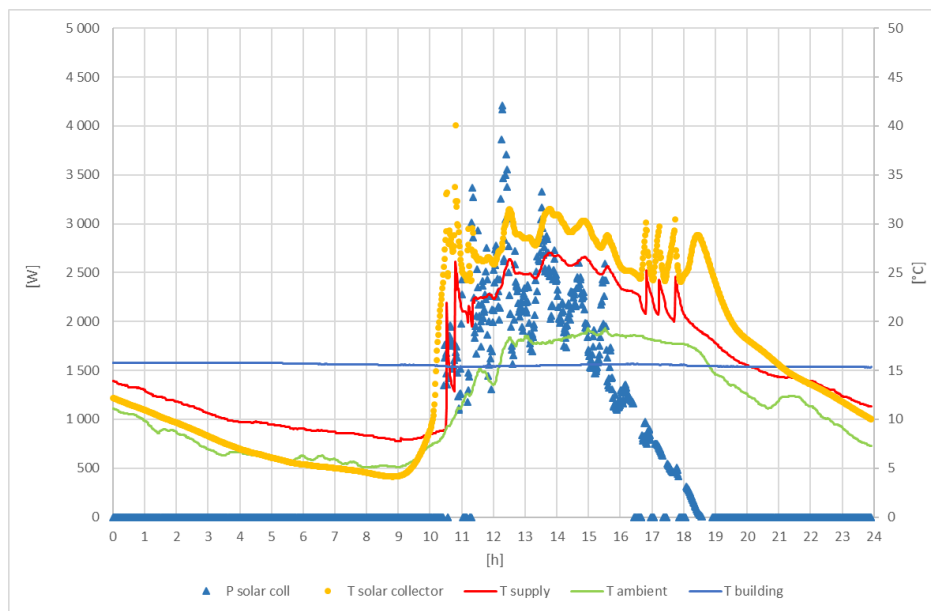

Fig. 7: Thermal performance of the AHU – Day 2, 08.01.2017

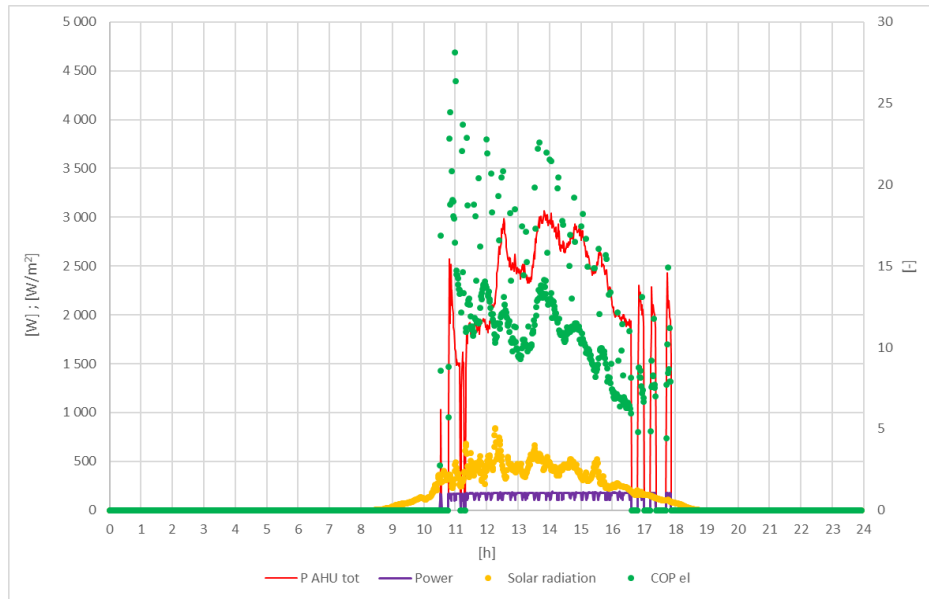

Fig. 8: Electrical performance of the AHU – Day 2, 08.01.2017

Tab. 4: Daily performance of the AHU for the two days considered

Description	Value Day 1	Value Day 2	Unit
Total electricity consumption	1.31	1.04	[kWh]
Incident solar radiation	40.6	21.9	[kWh]
Delivered thermal energy of AHU	22.0	11.9	[kWh]
Delivered thermal energy to the building	27.8	14.7	[kWh]
Solar heat produced	25.3	12.4	[kWh]
Operation hours	7.9	6.4	[h]
COP el	16.8	11.4	[-]
Solar collector efficiency	62%	57%	[-]

With regards of the cooling operation, two days of July are presented here below in Fig. 8 and 9 for the first day and in Fig. 10 and 11 for the second day.

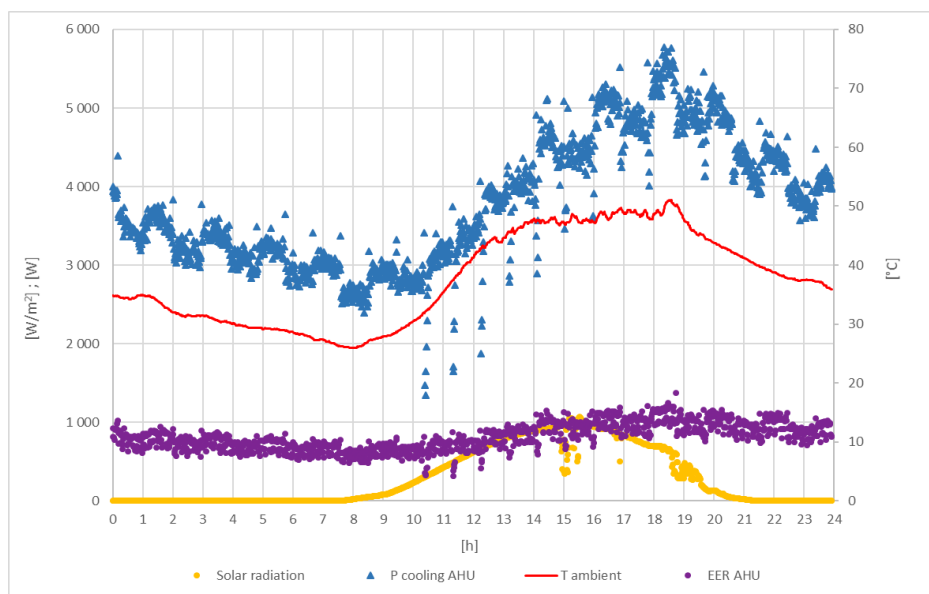

Fig. 8: Energy performance of the AHU – Day 1, 16.07.2017

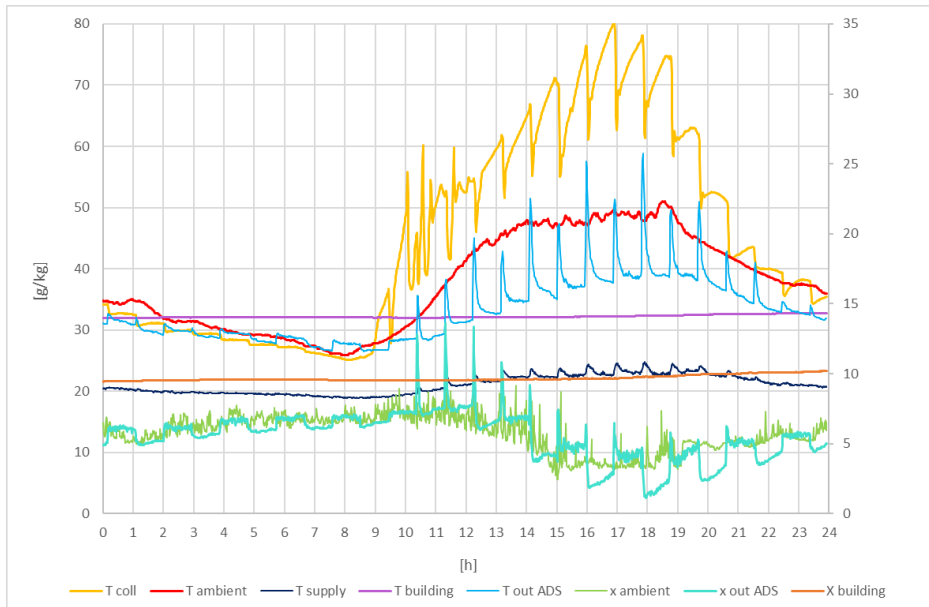

Fig. 9: Temperature and humidity ratio in the AHU – Day 1, 16.07.2017

The total incident solar radiation ranges between 50-60 kWh/day, and the cooling power produced by the AHU is between 2.5-5.5 kW, with a supply temperature of 19-22°C. First day is characterized by high solar radiation, extreme ambient temperatures (maximum value about 50°C), whereas second day has lower solar radiation and ambient temperatures up to 40°C. System has been operated 24 hours during the first day, and 10 hours during the second day. In the first day, the cooling power of the AHU produced during the night is only due to the indirect evaporative cooling effect.

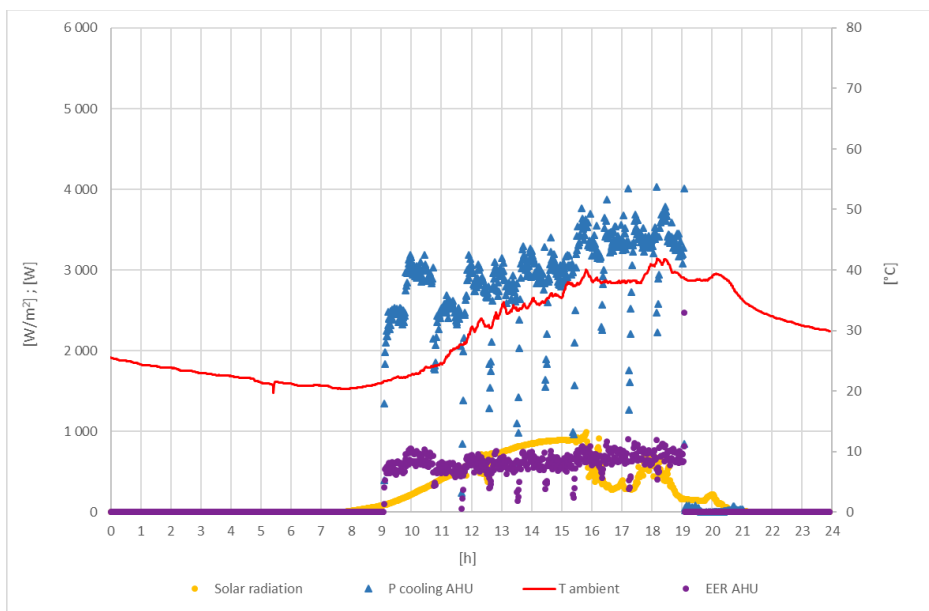

Fig. 10: Cooling performance of the AHU – Day 2, 23.07.2017

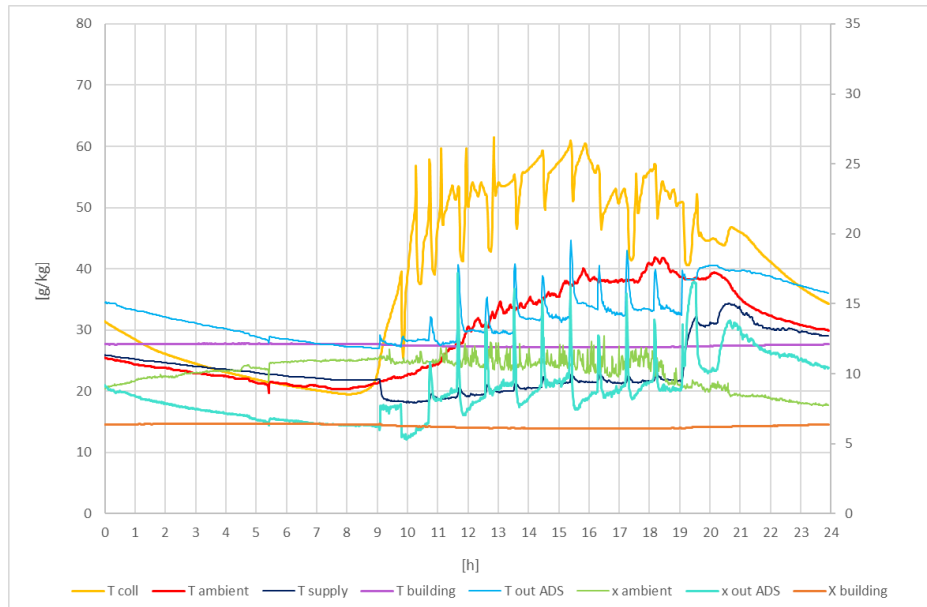

Fig. 11: Temperature and humidity ratio in the AHU – Day 2, 23.07.2017

Tab. 5: Daily performance of the AHU for the two days considered

Description	Value Day 1	Value Day 2	Unit
Cooling energy delivered by the AHU	91	29	[kWh]
Average flow rate	881	376	[m ³ /h]
Incident solar radiation	52.9	43.3	[kWh]
Solar collector heat	31.9	24.1	[kWh]
Electricity consumed	8.4	3.62	[kWh]
Specific power consumption for ventilation	0.40	0.96	[W/m ³ /h]
Hours of operation	24	10	H
EER	10.8	7.92	[-]
COP th	2.88	1.12	[-]
Solar collector efficiency	60%	56%	[-]

In Fig. 12 the daily performances in July are reported. The EER is always higher than 5, with peak values higher than 10, and an average value of about 7. Thanks to the very good performance of the evaporative cooling module of the AHU, the thermal COP of AHU varies between 1 and 2, with a strong influence of the external environmental conditions both in terms of temperature and relative humidity.

In the summer period the air flow rate has a daily modulation, managed by the PID controller since the control strategy implemented uses the building temperature and humidity as input parameters. In Fig. 9, monthly performances of the machine are depicted. The average air flow rate has a minimum value in the month of May, 400 m³/h and, whereas a maximum value of about 900 m³/h is reached in the month of August. The electricity consumption varies correspondingly both for the increase of the air flow rate and the daily working hours.

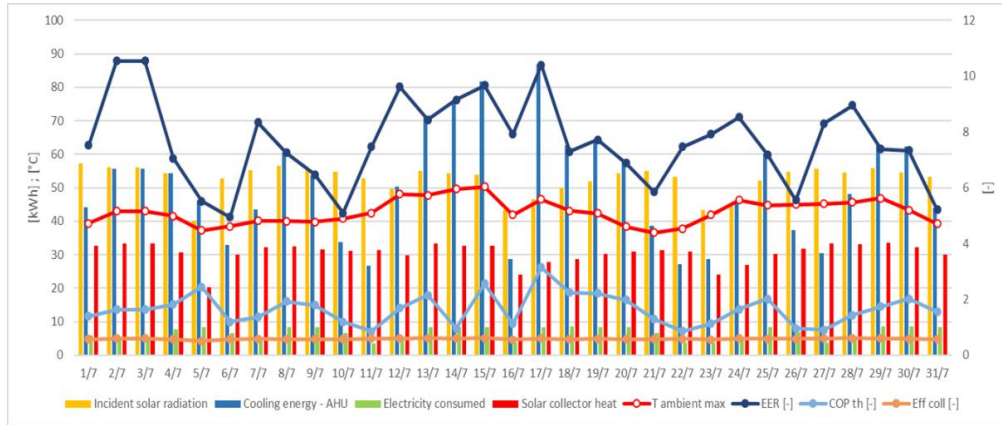

Fig. 12: Daily energy performances of the AHU – July 2017

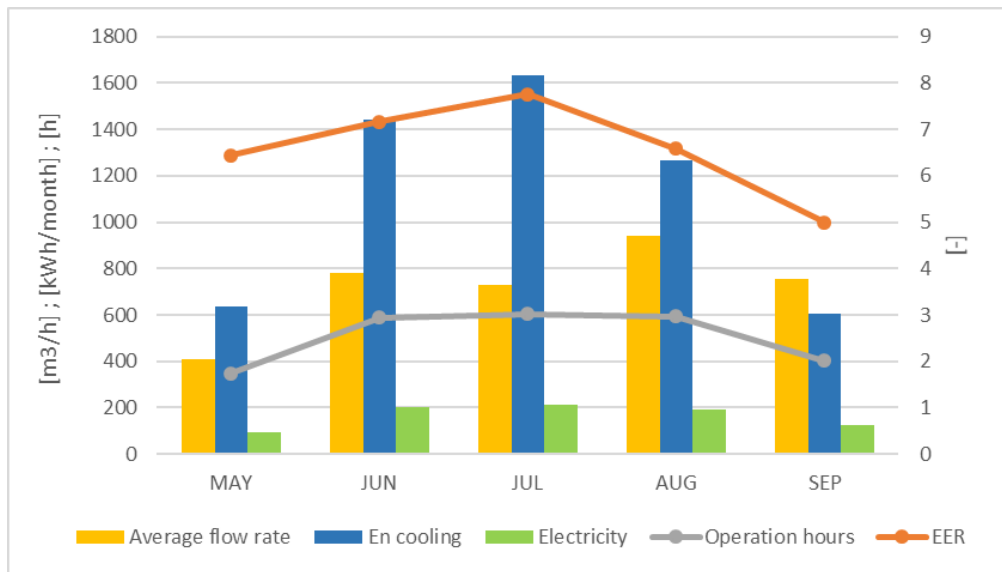

Fig. 13: Monthly energy performances of the AHU – July 2017

Tab. 6: Seasonal and yearly performance results

Description	Cooling	Heating	Year	Unit
Thermal energy – AHU	5527	960	6487	[kWh]
Thermal energy – BUI	2250	1109	3359	[kWh]
Average flow rate	714	623	668	[m ³ /h]
Incident solar radiation	6859	2008	8867	[kWh]
Solar collector heat	3966	1235	5200	[kWh]
Electricity consumed	820	90	910	[kWh]
Water consumption	11.6	0	11.6	[m ³]
Mean daily water consumption	83	0	-	[liters/day]
Specific power consumption for ventilation	0.46	0.35	0.40	[W/m ³ /h]
Hours of operation	2524	412	2937	[h]
Days of operation	139	59	198	[day]
EER	6.7	11	7.1	[-]
COP th	1.39	0.78	-	[-]
Solar collector efficiency	58%	61%	59%	[-]

According to the results obtained, a comparison with the energy performances of a conventional AHU coupled with a vapor compression reversible heat pump has been assessed. The main hypotheses regarding the conventional system concern the energy efficiency ratio of the chiller/heat pump and the electricity consumption for the ventilation. Results show an electricity saving of 70 % over the year.

Tab. 7: Calculated annual energy performances for a conventional AHU coupled with a vapor compression reversible heat pump

EER for the chiller/HP (assumed)	3	[-]
Electricity consumed by the chiller/HP	2162	[kWh]
Specific power consumption for ventilation (assumed)	0.30	[W/m ³ /h]
Electricity consumed by the AHU for ventilation	589	[kWh]
Total electricity consumed	2751	[kWh]
Electricity saving	70	[%]

3. Conclusions

In this work the energy performance of a innovative DEC AHU working with the freescoo concept has been presented. The system has been monitored both in cooling and heating operation and results showed the high energy saving potential of technology.

Summer operation has been characterized by a lower electrical efficiency of the AHU in comparison to the winter operation (6.7 versus 11). The main reason is the dry climate that characterizes the summer season of Marrakech, and the low latent load of the building. As a result, the latent part of the cooling power produced by AHU was much lower than the maximum potentiality of the machine.

Global results can be considered anyway very good, both in terms of instantaneous and long-term behaviour.

The comparison with the energy performances of a conventional AHU coupled with a vapor compression reversible heat pump shows that the freescoo AHU can save 70% of electricity.

Water consumption amounted to about 12 m³ for the summertime. This is a relevant aspect that can limit the application of the mentioned technology in climates with scarcity of water.

4. Acknowledgements

The mentioned project has been realized with the support of the Italian company Pleion srl which provided the solar collectors and their large experience in the solar thermal area.

4. References

- Finocchiaro P, Beccali M, Innovative compact solar air conditioner based on fixed and cooled adsorption beds and wet heat exchangers. *Energy Procedia* 2014; 819:827–48.
- Finocchiaro P, Beccali M, Gentile V. Experimental investigation of adsorption performances of an heat exchanger packed with silica gel for application in solar desiccant cooling systems. *Proceedings of OTTI 5th Solar Air-Conditioning Conference, Black Forest: 25 – 27 Sept 2013*, p. 210-215
- Finocchiaro P, Beccali M, Lo Brano, Gentile V. Monitoring results and energy performances evaluation of freescoo solar DEC systems. *SHC 2015 International Conference on Solar Heating and Cooling for Buildings and Industry Energy Procedia* 2015;