

Influence of the vehicle front shape in Teenage Cyclist-Vehicle Crash

FILIPPO CAROLLO, VINCENZO NASO

Dipartimento di Ingegneria Meccanica e Aerospaziale
University of Roma
Via Eudossiana 18, Roma
ITALY

Filippo.carollo@uniroma1.it vincenzo.naso@uniroma1.it

GABRIELE VIRZI' MARIOTTI, LUIGI CANNIZZARO

Dipartimento DIID
University of Palermo
Viale delle Scienze ed. 8, Palermo
ITALY

Gabriele.virzimariotti@unipa.it luigi.cannizzaro@unipa.it

Abstract: In this work the data, obtained for the three vehicles (sedan, SUV and Pick Up), tested in previous works, are compared. Following the results found in the literature, particular emphasis is done on the speed of the teenager cyclist head at the instant of impact and the diagrams of the head speed and the chest obtained in the simulations are shown. The speed of the head is that absolute, and this is used for processing the data and the subsequent determination of the best values of the three geometric actual parameters identified in front of the vehicle. Absolute speed is preferred because using the relative speed respect to vehicle, some amounts that cannot be disregarded are omitted from the evaluation. The chosen speed is 30 km/h because higher values appear too dependent on the mass of the vehicle, while lower values may not result in serious injury and are therefore less attractive. The procedure, to obtain the optimal values of the height of the bumper, the height of the bonnet and of the inclination angle of the bonnet is illustrated in the case the side impact vehicle-teenager cyclist. The conclusion is made that analogous procedure can be applied to HIC values.

Key-Words: teenage bicyclist, vehicle impact, bumper height, bonnet height, bonnet angle

1 Introduction

Many works are found in literature on the impact between vehicle and teenager [1] [4] or adult pedestrian [2] [3] [5] [10] [18] [23] [28] [29], also numerous works study the impact between the vehicle and the adult cyclist [9] [11] [13] [16] [17] [20] [21] or both cyclist and pedestrian [6] [7] [8] [12] [22], but the papers on the accident vehicle - teenager cyclist; are not numerous in literature [14] [15] [19] [35] [36] [37]. In [21] Authors indicate that car-mounted countermeasures designed to mitigate pedestrian injury have the potential to be effective even for bicyclists.

In general multibody technique is the applied method for numerical simulation; the most widely used programs are MADYMO, Aprosys, PC Crash, while Sim Wise is effectively used in this paper.

Studies give an idea of the shape of the front of the vehicle in order to reduce injuries, that may arise due to the impact [18] [29], but these works are not

frequent in literature. In particular the works [21] [22] [23] also address the crash between SUV vehicle against cyclist or pedestrian, but other papers on Pick up – cyclist impact are not found, over the paper [42]. This extends the results already achieved in the papers [14] [15] [37] where the damages caused by the energy impact of a teenage cyclist with a sedan car are taken into account and analyzed. Analogous crash is studied in case of vehicle constituted by a SUV [35] [36] instead than a normal sedan, in order to fill the gap in literature: references are found only to an adult or to a child, in many cases without taking into account the type of vehicle.

The influence of the front of the vehicle on the injury of the cyclist or pedestrian is a topic that is not frequently found in the literature. In [33], [34] Authors investigate the deploying time (or response time) of an active hood lift system (AHLS) of a passenger vehicle activated by gunpowder actuator,

while in [38] four vehicle types including large and compact passenger cars, minivans and light trucks are simulated according to their frequency of involvement in real world accidents. The influences of various vehicle front shape and compliance parameters are analysed. Moreover, the possible countermeasures on basis of vehicle front design to mitigate the injury severity of the pedestrians were discussed. A campaign of virtual simulations is conducted with the availability of the virtual models: sedan [14], SUV [35] and Pick Up [42] teenage cyclist, in order to quantify the damage caused to the head and chest on the basis of certain criteria such as HIC and 3 ms criterion [24] [25]. The results of the head speed of the previous executed simulations are analysed in order to quantify the influence of the front part of the vehicle on the injury of the cyclist head.

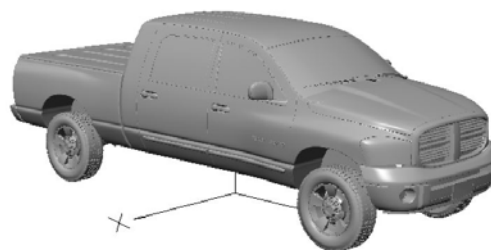

Fig.2: Pick-up in Sim Wise

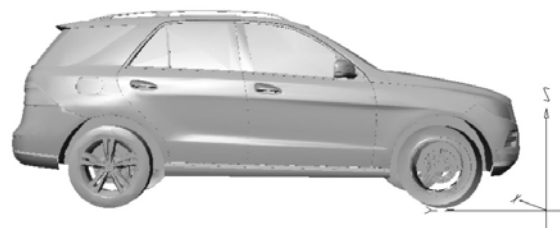

Fig. 3: SUV in SIM Wise



Fig. 4 – sedan in Sim Wise

2 Implementation of Virtual Models

The paper [1] is very useful for the study of anthropomorphic model of the human figure of a teenager, understood as a complex of bones, muscles and joints, while the paper [3] has analogous value for the adult; the book [26] and the paper [27] are very useful for the chassis design and the geometry of the bike (fig. 1). The implementation of the virtual model of the bike is the same for SUV, Pick up and sedan simulations [14] [35] [36].

Virtual simulations, performed with Sim Wise, allowed quantifying the damages in the teenager cyclist – Pick Up impact on head and chest.

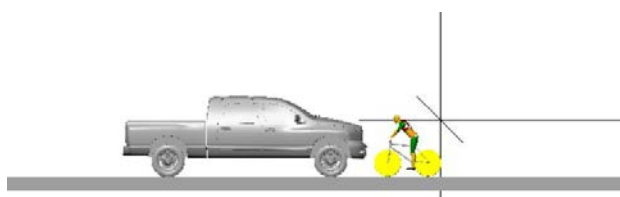

Figure1: cyclist model in Sim Wise

The information on pitch, height, length was provided by the manufacturer itself. Autodesk 3D Studio Max software is used to get the STL model, which was subsequently imported into Sim Wise (fig. 2, 3 and 4), attributing the masses, the centres of gravity and inertia moments of the individual components such as wheel, body, chassis, bonnet, front bumper; these parameters are essential for the proper conduct of the tests and the acquisition of results.

3 Vehicle- cyclist crash test

This paragraph illustrates, through the use of charts, tables and representations, the tests to assess the damage produced on teenage cyclist under varying condition of impact, in order to calculate the speed of the head and the chest for the evaluation of injuries. Dynamic of impact of teenage cyclist – vehicle is reconstructed by Sim Wise.

The relative positions between the vehicle and the cyclist are the same as those used for already examined vehicles [14] [15] [35] [36] [37]. The positions are three: In the first the teenage cyclist is positioned on the roadway with the side facing the vehicle about to occur (side impact); in the second case the cyclist is located opposite the vehicle about to occur (frontal impact), while in the third and last case the cyclist is placed behind the vehicle (telescoping or rear impact). Crash tests are executed at four different speeds: 20 km/h, 30 km/h, 40 km/h and 50 km/h.

The parameters measured during the tests are:

- Acceleration in the head gravity centre;

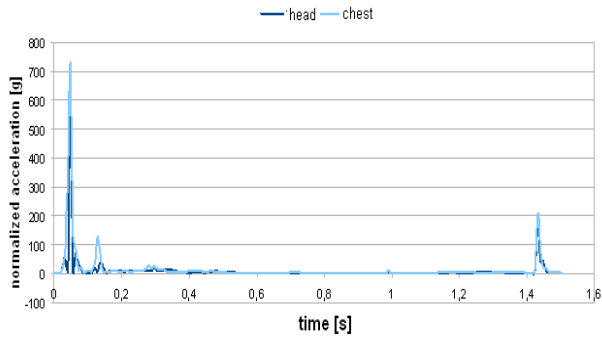

Figure 3: Head and chest acceleration in the side impact at 40km/h

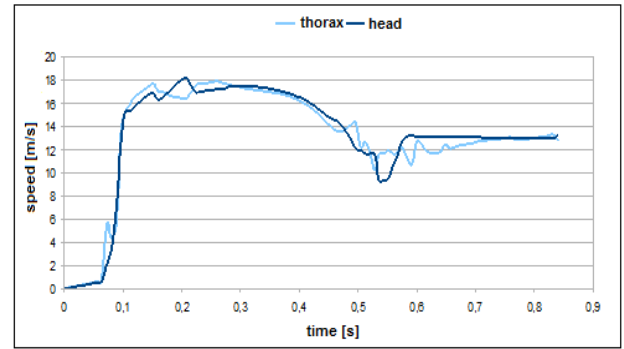

Fig. 7 - Thorax and head speed in the frontal impact with PICK UP at 40km/h

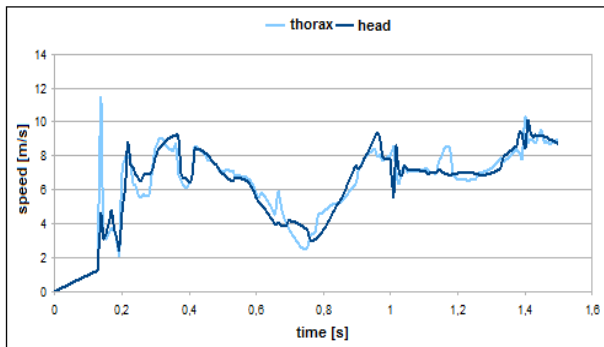

Fig. 4 – Thorax and head speed in the frontal impact with sedan at 20 km/h

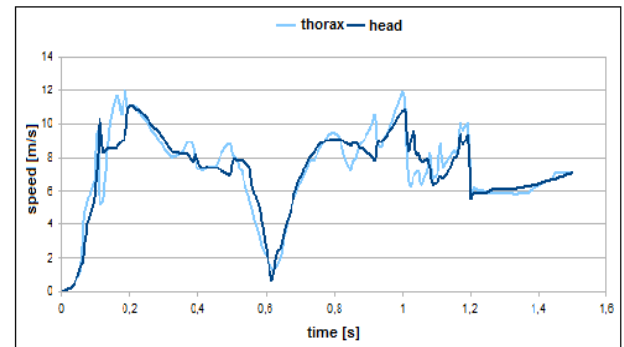

Fig. 8 - Thorax and head speed in the side impact with sedan at 30km/h

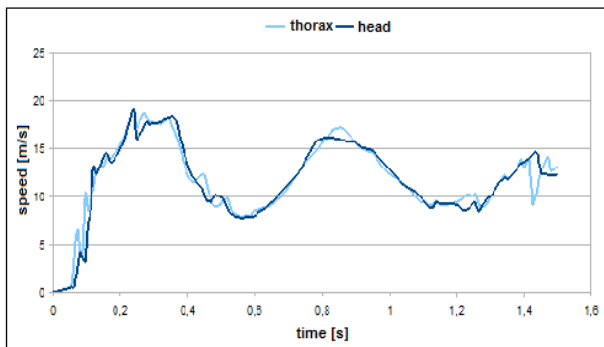

Fig. 5 - Thorax and head speed in the frontal impact with sedan at 50 km/h

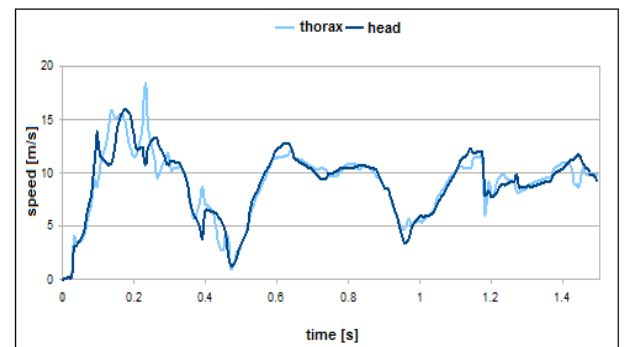

Fig. 9 - Thorax and head speed in the side impact with sedan at 40km/h

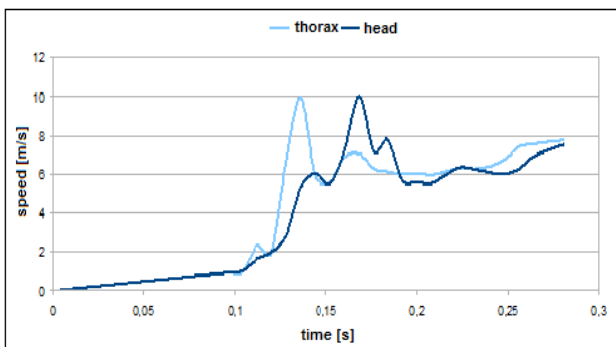

Fig. 6 - Thorax and head speed in the frontal impact with SUV at 30 km/h

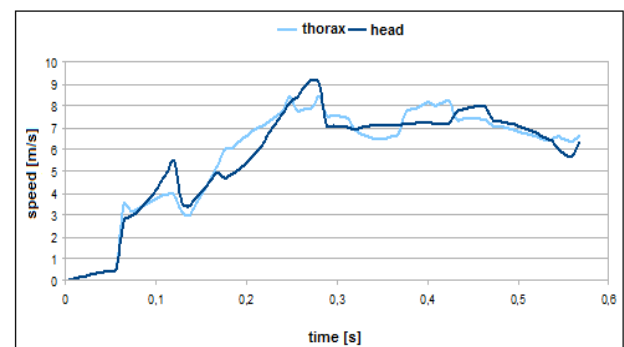

Fig. 10 - Thorax and head speed in the side impact with SUV at 20km/h

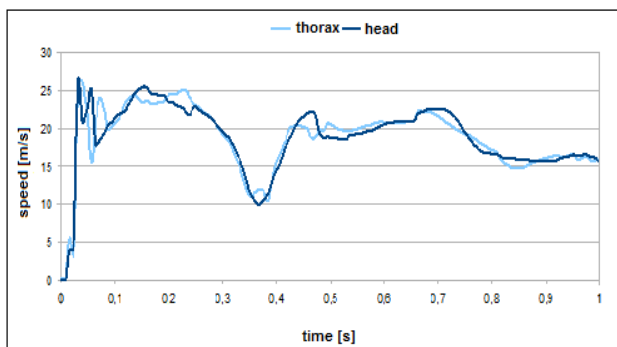

Fig. 11 - Thorax and head speed in the side impact with PICK UP at 50km/h

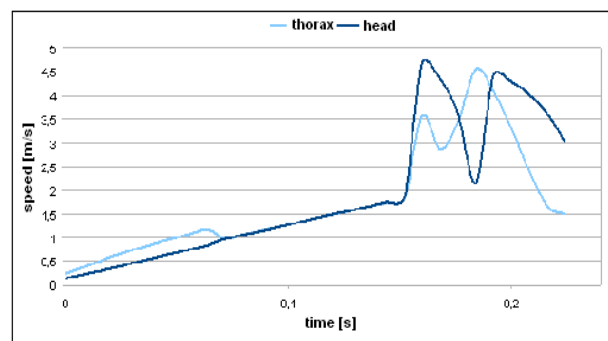

Fig. 14 - Thorax and head speed in the telescoping with PICK UP at 20km/h

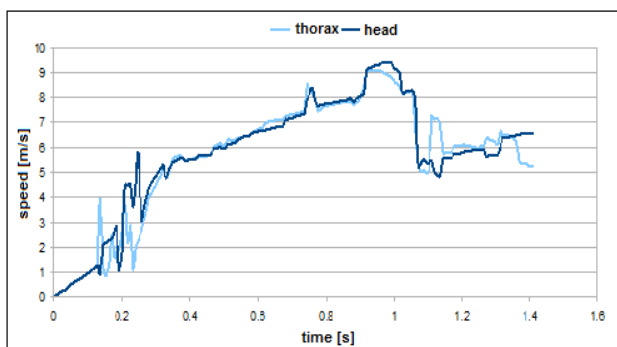

Fig. 12 - Thorax and head speed in the telescoping with sedan at 50km/h

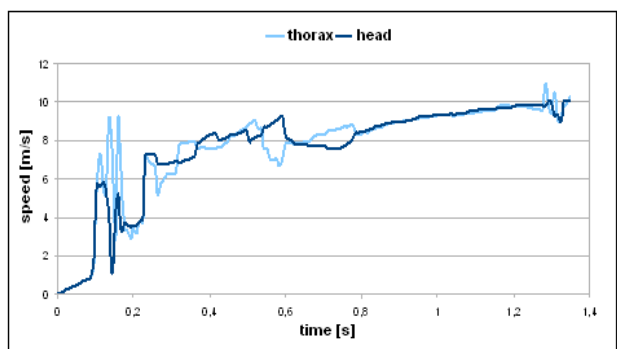

Fig. 12 - Thorax and head speed in the telescoping with sedan at 30km/h

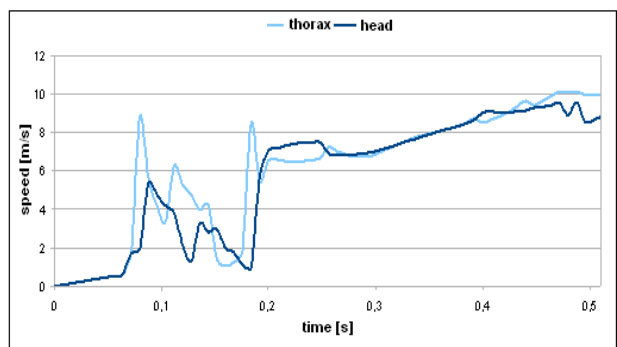

Fig. 13 - Thorax and head speed in the telescoping with SUV at 40km/h

- Acceleration in the chest gravity centre.

Fig. 3 shows an example of acceleration performances of the head and thorax. In the previous papers this data are analyzed and elaborated in order to quantify the damage of the head and the thorax.

3.1 Head impact speed

The parameters measured in the simulations are:

- resulting speed of the head gravity center;
- resulting speed in the thorax gravity center.

Fig. 4 – 14 show the trend of the head and thorax speed versus the time for many executed simulations.

Table 1 shows the obtained results with the values of the maximum impact speed of the thorax and of the head, with the contact time.

Figures 15, 16 and 17 show the trend and the visual comparison.

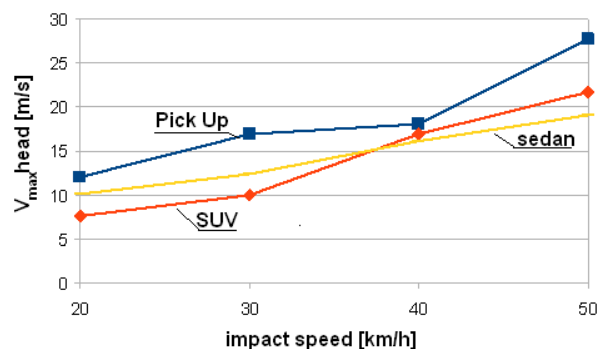

Fig. 15: maximum head speed in the frontal impact.

These three figures show that the sedan gives the best performance under all conditions of impact compared to other vehicles. This may depend on the gentler shaping of the front; exception to the low speed collision in which the speed of impact of the head take on greater values than other vehicles. In general the resulting speed of the head of the cyclist is greater if the vehicle has high front.

Table 1: max impact speed of the thorax and of the head and the contact time.

vehicle	posit.	Impact speed [km/h]	V _{max} head [m/s]	V _{max} thorax [m/s]	T _{contact} [ms]
Sedan	Front	20	10,10	11,44	1408
Sedan	Front	30	12,35	12,20	544
Sedan	Front	40	16,18	16,05	360
sedan	Front	50	19,13	19,25	240
SUV	Front	20	7,67	10,20	352
SUV	Front	30	10,04	9,96	168
SUV	Front	40	16,93	16,32	352
SUV	Front	50	21,73	20,40	264
PickUP	Front	20	12,10	12,30	528
Pick UP	Front	30	16,88	16,80	200
Pick UP	Front	40	18,12	17,92	208
Pick UP	Front	50	27,74	25,90	64
Sedan	Side	20	8,29	8,11	272
sedan	Side	30	11,13	11,96	208
sedan	side	40	16,03	18,49	176
sedan	side	50	16,98	17,26	176
SUV	side	20	9,18	8,43	272
SUV	side	30	10,29	10,76	272
SUV	side	40	17,77	18,28	200
SUV	side	50	20,11	19,50	192
Pick UP	side	20	8,51	10,10	96
Pick UP	side	30	12,88	13,06	64
Pick UP	side	40	21,58	20,78	208
Pick UP	side	50	26,13	26,20	32
sedan	rear	20	9,42	9,11	984
sedan	rear	30	10,11	10,98	1348
sedan	rear	40	10,17	9,82	600
sedan	rear	50	15,87	14,45	176
SUV	rear	20	7,19	7,25	640
SUV	rear	30	9,81	9,33	544
SUV	rear	40	9,57	10,13	472
SUV	rear	50	13,39	13,96	552
Pick UP	rear	20	4,69	4,57	160
Pick UP	rear	30	10,67	10,69	248
Pick UP	rear	40	14,99	15,01	232
Pick UP	rear	50	20,61	19,41	128

In [38] several simulations of vehicle – pedestrian crash are executed by the multibody program MADYMO; in it a simulation technique is applied giving the relative velocity of the head impact speed, while the absolute vales are obtained by the technique adopted in this work, so that no numerical or qualitative comparison can be executed.

The reason is basically the following: indicating with m_1 the mass of the vehicle and m_2 the mass of the rider (or pedestrian), an instant before the

impact, if the speed of the cyclist is neglected, the momentum of the system is given by $m_1 v_1$. The two bodies begin to move with speed v_2 due to the initially inelastic impact, so that the conservation of momentum states:

$$m_1 v_1 = (m_1 + m_2) v_2. \quad (1)$$

Since m_1 is very greater than m_2 , the solution $v_2 = v_1$ is fairly reliable, so that after the impact instant the rider has a relative speed very close to the absolute speed of the vehicle. The speed v_2 is actually a few less than the speed v_1 , because during the impact phase, which endures small milliseconds, strong impulsive forces are awakened, then strong accelerations vary the kinematic behavior of the vehicle-cyclist system. These accelerations are strongly dependent on the vehicle mass and are in part neglected by examining the relative motion. Looking directly at the relative speeds, the influence of the mass of the vehicle is completely eliminated, but this may modify the dynamic behavior of the system.

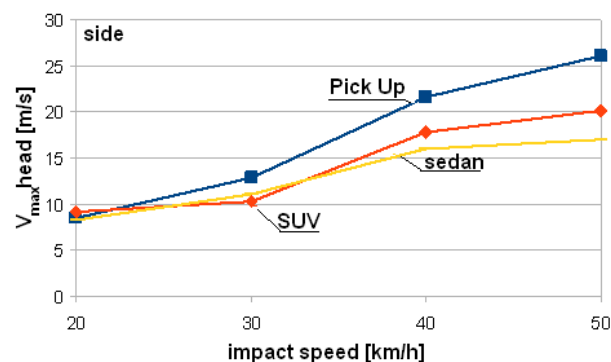

Fig. 16: maximum head speed in the side impact.

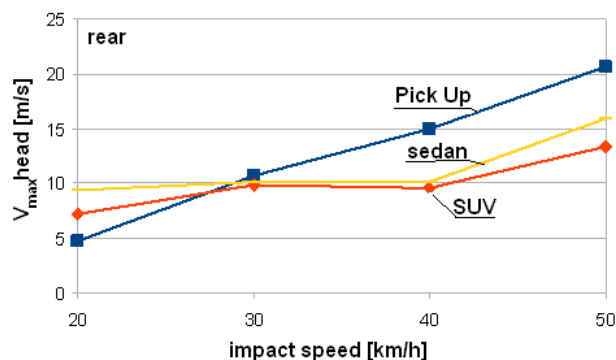

Fig. 17: maximum head speed in the telescoping.

4. Best values evaluation and discussion

Table 2 shows the geometric characteristic of the examined vehicles; fig. 18 shows the geometrical position. In the last row of the table the reported

best values are calculated by the method described in the following.

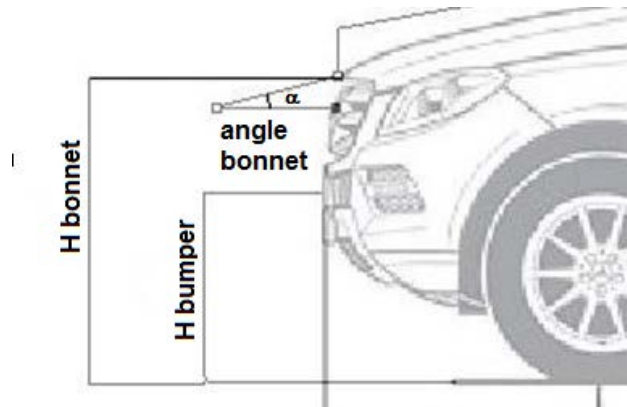

Figure 18 – parameters of the evaluation

Table 2- geometric characteristics of the vehicles

vehicle	Bonnet height [mm]	Bumper height [mm]	Bonnet angle [degrees]
sedan	847	390	20
SUV	999	556	14
Pick Up	1087	659	11
Best values	942	495.5	16.4

Figures 15, 16 and 17 allow the following considerations:

- The impact speed of the head of the teenage cyclist increases varying the considered vehicle.
- The mass of the coming up vehicle is important for the injury gravity only at greater or equal speed than 40 km/h [43].
- Examining the results of the paper [1], the teenage pedestrian head speed is greater than the teenage cyclist, since a part of the impact energy is dissipated by the bike chassis.

Following the ideas order in [38], the case of lateral impact can be examined to obtain the best value of some evaluation parameters.

Figure 19 and 20 show the trend of the head impact speed in the case of side impact versus the bumper height and the bonnet height respectively, for the several examined vehicle speeds. Of course three points for each speed are few to obtain an optimized result, so that a greater number of vehicles have to be examined to improve the result. One can note that the speed 40 and 50 km/h can be discarded since the result is influenced by the vehicle speed as paper [43] shows; the speed 20 km/h can be discarded since the speed is too low to arouse high injuries in the cyclist, so that the curve at speed 30

km/h can be manipulated to obtain the best values of the examined parameters.

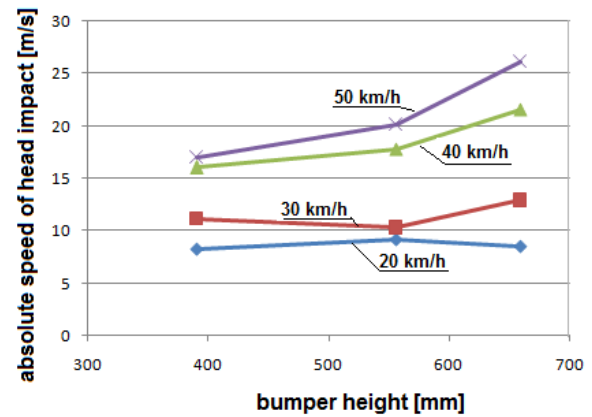

Figure 19 - Head impact speed versus the bumper height (side impact)

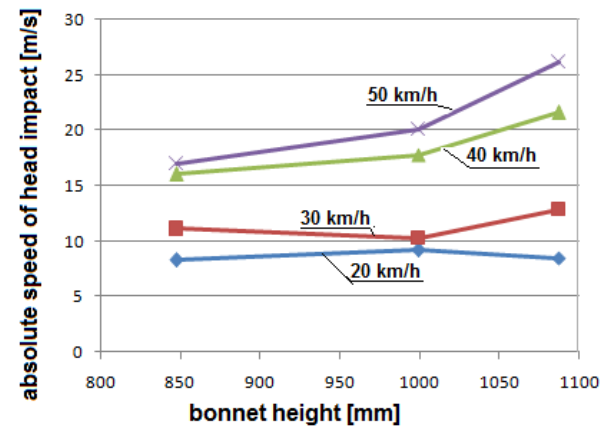

Figure 20 - Head impact speed versus the bonnet height (side impact)

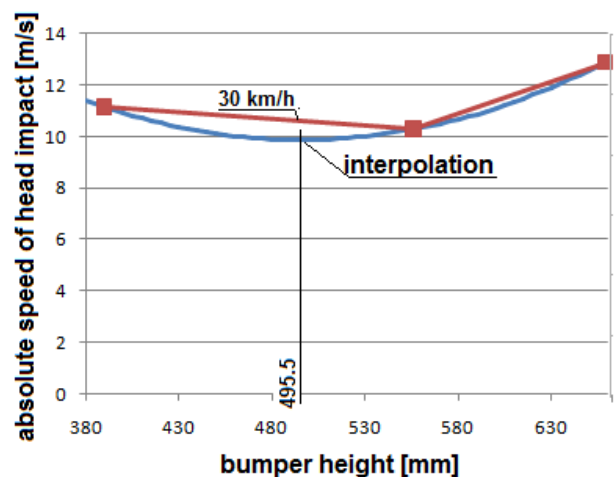

Figure 21- best value of the bumper height.

No particular optimization procedure is applied in this case, but the three points are interpolated by a parabola; fig 21 and 22 show the relative curve.

Fig. 21 shows the best value of the bumper height corresponding to the minimum of the parabola and the minimum value of the head impact speed (9.88 m/s).

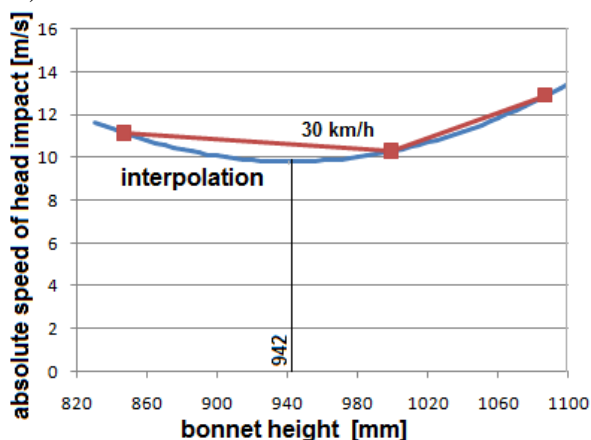

Figure 22- best value of the bonnet height.

Fig. 22 shows the best value of the bonnet height, corresponding at head impact speed equal to 9.81 m/s.

One can note that, in a suitable way, the same procedure should be applied to HIC values, nevertheless obtaining less satisfactory results. The values of the best values are a few different.

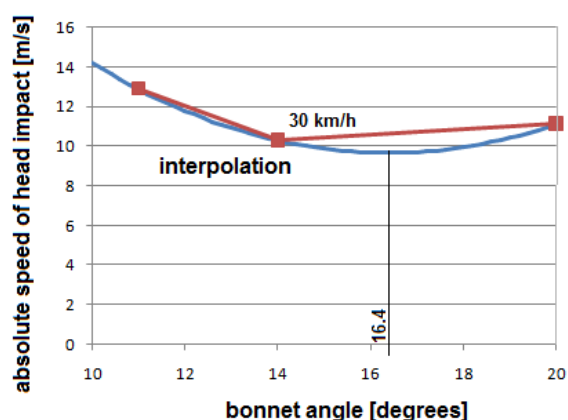

Fig. 23 – best value of the bonnet angle

Figure 23 shows the analogous determination for the bonnet angle; one can note that this value does the difference among the three examined vehicles, but the relative point of the Pick Up is inserted also if the head impact point is in a lower position than the bonnet height [43]. The head impact speed corresponding to the best value is 9.66 m/s.

The above procedure is executed for lateral crash only; its application to the other impact positions may give a few different results.

Results obtained in this work cannot be considered definitive; best results can be obtained by increasing the number of examined vehicles, and also

considering the other possible positions of impact. They may be used as the starting data for the mathematical procedures that can lead to improve the result.

5 Conclusions

In this work the impact performance with a teenager cyclist of three vehicles tested in previous works are compared. The lateral impact is chosen among the three different studied positions, following the suggestions of other determinations in literature. A literature research has allowed the identification of the following determinants geometric parameters of the frontal part of the vehicle: bumper height, bonnet height, bonnet angle, while the parameter used for the determination of the optimal values is the absolute speed of the head in the impact instant. The procedure for determining the optimal values cannot be defined as shape optimization, because the classical procedures cannot be applied for the skimpiness of available values. The obtained values are greatly enhanced in the conditions of a side impact teenage cyclist vehicle, even at different speeds from that of calculation. A similar procedure, not shown in the work, can be applied to the HIC values, obtaining small variations of the best values. The vehicles offering the best shape performance, among those examined, is the SUV, the speed of impact of the head is close enough to the minimum; in the determination with HIC, the representative point of this vehicle occupies a very close position to the minimum.

Next development of this work is the application of similar procedures for the chest, performing a compromise choice between the values obtained to minimize the injuries of the head and chest.

References:

- [1] G. Virzi, Mariotti, S. Golfo, Determination and analysis of the head and chest parameters by simulation of a vehicle-teenager impact, *Proceedings of the Institution of Mechanical Engineers, Part D: Journal of Automobile Engineering*; Vol 228(1), 2014, 3–20
- [2] G. Bellavia, G. Virzi, Mariotti, Multibody Numerical Simulation For Vehicle – Pedestrian Crash Test, *Ingegneria dell'autoveicolo ATA* Vol. 62, 11/12, 2009, pp 40-49 ISSN: 0001-2661; *XXI Science and Motor Vehicles 2007, JUMV international Conference with Exhibition*, 23-24 April 2007, Belgrade, Serbia, ISBN 978-86-80941-31-8

- [3] G. Bellavia, G. Virzi' Mariotti, Development of an Anthropomorphic model for Vehicle – Pedestrian Crash Test, *Ingegneria dell'Autoveicolo*, vol. 62, n. 3/4 marzo aprile 2009, pag. 48-56; *XXI Science and Motor Vehicles 2007, JUMV international Conference with Exhibition*, 23-24 April 2007, Belgrade, Serbia, ISBN 978-86-80941-31-8
- [4] A. F. Williams, J. Tison, Motor vehicle fatal crash profiles of 13-15-year-olds, *Journal of Safety Research*, 43, 2012, 145-149
- [5] M. Kleinberger, E. Sun, R. Eppinger, S. Kuppa, R. Saul, Development of Improved Injury Criteria for the Assessment of Advanced Automotive Restraint Systems, *National Highway Traffic Safety Administration*, September 1998
- [6] J. W. Watson, Investigation of Cyclist and Pedestrian Impacts with Motor Vehicles using Experimentation and Simulation, *PhD thesis*, Cranfield University, feb. 2010
- [7] Y. Peng, Y. Chen, J. Yang, D. Otte, R. Willinger, A study of pedestrian and bicyclist exposure to head injury in passenger car collisions based on accident data and simulations, *Safety Science* 50 (9), 2012, 1749-1759
- [8] Q. Chen, Y. Chen, O. Bostrom, Y. Ma, E. Liu, A comparison study of car-to-pedestrian and car-to-E-bike accidents: Data source: The China in-depth accident study (CIDAS), *SAE Technical Paper* 2014-01-0519, 2014, doi:10.4271/2014-01-0519.
- [9] M. X. Xu, Reconstruction analysis of car-electric bicycle side impact accident based on PC-Crash, *Journal of Chang'an University (Natural Science Edition)*, ISSN: 1671-8879, 33, 1, 2013, 85 - 88+99
- [10] N. Chaurand, P. Delhomme, Cyclists and drivers in road interactions: A comparison of perceived crash risk - *Accident Analysis and Prevention* 50, 2013, 1176–1184
- [11] G. Milne, C. Deck, N. Bourdet, (...), R. P. Carreira, R. Willinger, Assessment of bicyclist head injury risk under tangential impact conditions, *2013 IRCOBI Conference Proceedings - International Research Council on the Biomechanics of Injury*, pp 735-746.
- [12] T. Maki, J. Kajzer, K. Mizuno, Y. Sekine, Comparative analysis of vehicle–bicyclist and vehicle–pedestrian accidents in Japan, *Accident Analysis & Prevention*, Volume 35, Issue 6, 2003, 927–940
- [13] J. Ki Kim, S. P. Kim, G. F. Ulfarsson, L. A. Porrello, Bicyclist injury severities in bicycle–motor vehicle accidents, *Accident Analysis & Prevention* 39, 2, 2007, 238–251
- [14] F. Carollo, G. Virzi' Mariotti, E. Scalici - Injury Evaluation in Teenage Cyclist-Vehicle Crash by Multibody Simulation - *WSEAS Transactions on Biology and Biomedicine*, ISSN/E-ISSN: 1109-9518/2224-2902, Volume 11, 2014, Art. 26, pp. 203-217
- [15] F. Carollo, G. Virzi' Mariotti, E. Scalici - Biomechanics Parameters in the Vehicle-Cyclist Crash with Accident Analysis in Palermo – *Recent Advances in mechanical Engineering, NAUN Conference ECME'14*, Firenze 22-24 November 2014, pp 139-148, ISBN: 141 978-960-474-402-2.
- [16] M. van Schijndel, S. de Hair, C. Rodarius, R. Fredriksson, Cyclist kinematics in car impacts reconstructed in simulations and full scale testing with Polar dummy, *IRC-12-85 IRCOBI Conference* 2012, pp 800-812
- [17] R. Fredriksson, E. Rosén, Priorities for Bicyclist Protection in Car Impacts – a Real life Study of Severe Injuries and Car Sources, *IRC-12-85 IRCOBI Conference* 2012, pp 779- 786
- [18] D. T. Detweiler, R. A. Miller, Development of a sport utility front bumper system for pedestrian safety and 5 mph impact performance, *Proceedings of the 17th International Technical Conference on the Enhanced Safety of Vehicles*, Paper Number 01-S6-W-145, Amsterdam, The Netherlands, June 4-7, 2001.
- [19] F. Carollo, Analisi di alcuni parametri biomeccanici nello studio d'impatto auto bici, *graduate thesis*, Palermo, 2014
- [20] E. van Hassel, R. de Lange, Bicyclist safety in bicycle to car accidents: an inventory study, *TNO report 06.OR.SA.031.1/RDL*, August 17, 2006.
- [21] S. Mukherjee, A. Chawla, D. Mohan, M. Singh, R. Dey, Effect Of Vehicle Design On Head Injury Severity And Throw Distance Variations In Bicycle Crashes - *Proc. of TRIPP conference*, New Delhi Paper no: 07-0467
- [22] O. Fanta, K. Jelen, H. Purš, Interaction between Cyclist and Car during Broadside and Confrontation with Pedestrian Throw Formulas Multibody Simulation -*Transactions on Transport Sciences* V. 3, N 3, pp. 99-106. DOI: 10.2478/v10158-010-0014
- [23] C. K. Simms, D. P. Wood, Pedestrian risk from cars and sport utility vehicles – a comparative analytical study, *Proc. ImechE Part D J. Automobile Engineering*, Vol. 220 (8), 1085-1100 (2006)

- [24] K. U. Schmitt, P. F. Niederer, M. H. Muser, F. Walz, *Trauma Biomechanics: Accidental injury in traffic and sports*, Springer London, 2007
- [25] A. M. Nahum, J. W. Melvin, *Accidental Injury: Biomechanics and Prevention*, Springer, London, 2001
- [26] S. Battaglia, I. Damiani, G. Virzi' Mariotti, *La bicicletta sportiva. Caratteristiche geometriche ed inerziali. Simulazione dinamica*, ISBN 88-548-0801-6, Aracne, Roma, 2006.
- [27] F. Giannitrapani, G. Virzi' Mariotti, Dynamic Analysis of Motorcycle Behaviour on the Road with Steering Plate Structural Optimisation, *EAEC Conference*, Belgrade, 30th May – 1th June 2005
- [28] A. Şoica, S. Lache, Theoretical and Experimental Approaches to Motor Vehicle–Pedestrian Collision, *3rd WSEAS International Conference on Applied and Theoretical Mechanics*, Spain, December 14-16, 2007, pp 263-268
- [29] M. D. Iozsa, D. A. Micu, S. Cornelia, I. A. Ionuţ, *Analytical Estimation of the Hood Behaviour during an Impact with a Pedestrian Head*, Recent Advances in Civil Engineering and Mechanics, ISBN: 978-960-474-403-9, pp 195-198
- [30] J. Yang, J. Yao, D. Otte, *Correlation of Different Impact Conditions to the Injury Severity of Pedestrians in Real World Accidents* - NHTSA, Washington, USA, paper number 05-0352
- [31] J. Kovanda, H. Kovandová, R. Ságl, Vehicle-pedestrian collision, simulation in SIMPACK - *User meeting 2001*. Bad Ischl, Rakousko, 2001
- [32] J. Svoboda, Z. Šolc, Pedestrian protection-Pedestrian in collision with personal car – *Czech Technical University in Prague, Faculty of Mechanical Engineering, Department of Automotive and Aerospace Engineering, Technická 4, 16607, Praha 6, Czech Republic*
- [33] T. H. Lee, G. H. Yoon, S. B. Choi, A Shock Mitigation of Pedestrian-Vehicle Impact Using Active Hood Lift System: Deploying Time Investigation, *Shock and Vibration*, Vol. 2016, Art. 7589598, 17 pages, <http://dx.doi.org/10.1155/2016/7589598>
- [34] T. H. Lee, G. H. Yoon, S. B. Choi, Deploying time investigation of automotive active hood lift mechanism with different design parameters of hinge part, *Advances in Mechanical Engineering*, April 2016 vol. 8, issue 4, pp 1-16 doi: 10.1177/1687814016645441
- [35] F. Carollo, G. Virzi' Mariotti, V. Naso - Biomechanics Parameters in Teenage Cyclist – SUV Accident and Comparison with the Pedestrian – *WSEAS-NAUN conference OTENG'15*, Rome, 7-9 November 2015; Applied Mathematics and Materials, Pag. 77-87, ISSN: 2227-4588.
- [36] F. Carollo, G. Virzi' Mariotti, V. Naso - HIC Evaluation in Teenage Cyclist – SUV Accident – *Recent Researches in Mechanical and Transportation Systems, NAUN Conference ICAT'15*, Salerno, Italy, June 27-29, 2015, pp. 252-259, ISBN 978-1-61804-316-0.
- [37] F. Carollo, G. Virzi' Mariotti, E. Scalici, Valutazione delle lesioni nell'impatto ciclista adolescente - veicolo con simulazione multibody, *Scienze e Ricerche*, n. 24, 1 marzo 2016, pp. 75-88
- [38] X.J. Liu, J.K. Yang, P. Lövsund, A Study of Influences of Vehicle Speed and Front Structure on Pedestrian Impact Responses Using Mathematical Models – *Traffic Injury Prevention*, 3:1, 31-42, 2010 ISSN:1538-9588
- [39] T. Katsuhara, H. Miyazaki, Y. Kitagawa, T. Yasuki, Impact Kinematics of Cyclist and Head Injury Mechanism in Car-to-Bicycle Collision, *Proceedings IRCOBI Conference 2014*, pp 670-684
- [40] S. Mukherjee, A. Chawla, D. Mohan, S. Chandrawat, V. Agarwal, Predicting throw distance variations in bicycle crashes. *Int. J. Vehicle Safety*, Vol. 1, No. 4, 2006, pp 304-315
- [41] D. Otte, Possibilities and limitation for protective measures for injury reduction of vulnerable road users, *International Journal of Crashworthiness*, 7:4, 441-462, doi:dx.doi.org/10.1533/cras.2002.0229
- [42] F. Carollo, V. Naso, G. Virzi' Mariotti - Teenage cyclist - Pick up crash by multibody simulation; HIC evaluation and comparison with previous results - *International Journal of Mechanical Engineering*, ISSN: 2367-8968, Vol 1, 2016, pp 75-83
- [43] Carollo F., Naso V., Virzi' Mariotti G., Injury and Throwing Distance in Teenage Cyclist-Vehicle Crash, *WSEAS Transactions on Power Systems*, ISSN/E-ISSN: 1790-5060/2224-350X, Volume 11, 2016, Art. #21, pp. 171-182