

## RESEARCH ARTICLE

# Intelligent Metasurface Layer for Direct Antenna Amplitude Modulation Scheme

MARWAH HALEEM JWAI<sup>1</sup>, TAHA A. ELWI<sup>2</sup>,  
MOHAMMAD ALIBAKHSHIKENARI<sup>3</sup>, (Member, IEEE),  
BAL S. VIRDEE<sup>4</sup>, (Senior Member, IEEE), HAYDER ALMIZAN<sup>5</sup>,  
ZAID A. ABDUL HASSAIN<sup>6</sup>, SYED MANSOOR ALI<sup>7</sup>,  
LIDA KOUHALVANDI<sup>8</sup>, (Senior Member, IEEE),  
PATRIZIA LIVRERI<sup>9</sup>, (Member, IEEE), NURHAN TÜRKER TOKAN<sup>10</sup>,  
GIOVANNI PAU<sup>11</sup>, (Member, IEEE), CHAN HWANG SEE<sup>12</sup>, (Senior Member, IEEE),  
AND ERNESTO LIMITI<sup>13</sup>, (Senior Member, IEEE)

<sup>1</sup>Department of Information and Communication Engineering, College of Information Engineering, Al-Nahrain University, Baghdad, Iraq

<sup>2</sup>International Applied and Theoretical Research Center (IATRC), Baghdad, Iraq

<sup>3</sup>Department of Signal Theory and Communications, Universidad Carlos III de Madrid, Leganés, 28911 Madrid, Spain

<sup>4</sup>Center for Communications Technology, London Metropolitan University, N7 8DB London, U.K.

<sup>5</sup>Department of Electronics and Communication Engineering, College of Engineering, University of Kufa, Najaf, Iraq

<sup>6</sup>Department of Electrical Engineering, College of Engineering, Mustansiriyah University, Baghdad, Iraq

<sup>7</sup>Department of Physics and Astronomy, College of Science, King Saud University, Riyadh 11451, Saudi Arabia

<sup>8</sup>Department of Electrical and Electronics Engineering, Dogus University, 34775 Istanbul, Turkey

<sup>9</sup>Department of Engineering, University of Palermo, 90128 Palermo, Sicily, Italy

<sup>10</sup>Department of Electronics and Communications Engineering, Yildiz Technical University, 34220 Esenler, Istanbul, Turkey

<sup>11</sup>Faculty of Engineering and Architecture, Kore University of Enna, 94100 Enna, Italy

<sup>12</sup>School of Computing, Engineering and the Built Environment, Edinburgh Napier University, EH10 5DT Edinburgh, U.K.

<sup>13</sup>Department of Electronic Engineering, University of Rome Tor Vergata, 00133 Rome, Italy

Corresponding authors: Taha A. Elwi (tahaelwi82@almamonuc.edu.iq), Mohammad Alibakhshikenari (mohammad.alibakhshikenari@uc3m.es), and Giovanni Pau (giovanni.pau@unikore.it)

Dr. Mohammad Alibakhshikenari acknowledges support from the CONnecting EXcellence (CONEX)-Plus programme funded by Universidad Carlos III de Madrid and the European Union's Horizon 2020 research and innovation programme under the Marie Skłodowska-Curie grant agreement No. 801538. The authors also sincerely appreciate funding from Researchers Supporting Project number (RSPD2023R699), King Saud University, Riyadh, Saudi Arabia.

**ABSTRACT** This paper proposes a transmitter system based on direct antenna amplitude-shift keying modulation for point-to-point microwave link. The proposed system is formed from a conventional microstrip antenna and a novel reconfigurable metasurface layer (RMSL). The proposed RMSL has two states: OFF (or Logic-0) and ON (or Logic-1) where each switching scenario provides a certain gain level. This is achieved through controlling the proposed RMSL switching configuration to control the amplitude of the transmitted signal. Results show that such a system can modulate electromagnetic signals directly by varying the antenna's gain from about 2 dBi for Logic-0 to 13.8 dBi for Logic-1. An analytical model-based ray-tracing technique is invoked to explain the operation of the proposed antenna system. To demonstrate the operation of the proposed system, both the antenna and the RMSL structures were fabricated, assembled and tested. Measurements show good agreement with the theoretical model and numerical simulations obtained using CST Microwave Studio software package. The overall system has dimensions of  $25 \times 25 \times 7.3 \text{ cm}^3$ .

**INDEX TERMS** ASK modulation, direct antenna modulation, microstrip antenna, reconfigurable metasurface.

The associate editor coordinating the review of this manuscript and approving it for publication was Debabrata K. Karmakar.

## I. INTRODUCTION

Amplitude-shift keying (ASK) is a digital modulation scheme that was invented for modern wireless communication

networks where the amplitude of the carrier wave is varied in accordance with the baseband data source [1]. In any wireless communication system, the carrier wave, which is a sinusoidal signal of a high frequency corresponding to the radio frequency (RF) channel of interest, is modulated with the baseband data prior to transmission. The digital signal is upconverted using a mixer, which is a nonlinear device. The output of the mixer needs to be filtered to remove intermodulation artifacts generated in the modulation process and the resulting signal is amplified with a power amplifier (PA) before transmission [1]. Unfortunately, high peak-to-average-power ratio of the baseband signals can cause the PA, which is a nonlinear device to generate spurious responses that can interfere with other wireless systems. To eliminate this issue a relative new technique has been developed and is referred to as direct antenna modulation (DAM) [2]. This modulation scheme uses the baseband data to control the radiation properties of an antenna to generate a modulated signal.

Various approaches of DAM have been presented in literature [3], [4], [5], [6]. Many researchers achieved ASK-DAM by controlling the antenna input impedance. In [7] it is shown that although reconfigurable antenna systems could fulfil the requirements for smart communication systems however, they have limitations for application in most types of modulation schemes. The authors in [8] designed a DAM based on array of switchable passive reflectors. Pulse duration modulation was achieved directly with a multiple/input-multiple/output (MIMO) system through timed switching for antennas [9].

In [10] a new feed mechanism is proposed for an electrically small antenna. Using this technique, an arbitrary amplitude-modulated waveform can be transmitted through a high-Q electrically small transient-state antenna. In [11] and [12] a new strategy involving direct transmission of data via programmable coding RMSL is employed to modulate a signal. In [13] it is shown that the use of metasurface structures can be used to enhance the performance of an antenna as well as the electromagnetic wave characteristics. Moreover, it is shown that metasurface can be used to for beam forming applications. In [14], a high gain RMSL-antenna is presented. This antenna was further developed in [15] to realize gain variation by changing the metasurface array dimensions. A reprogrammable hologram was produced based on a one-bit metasurface for imaging applications in [16]. In [17] microwave imaging is proposed based on 2-bit programmable metasurface for a single sensor at a single frequency. Scattering diffusion is improved in [18] using an active metasurface at THz frequencies. The authors of [19] presented dual band metasurface operating at microwave frequencies. In [20], a digital coding transmissive RMSL is proposed that produces multiple beams. In [21] and [22], a multifunctional coding RMSL has been suggested as a means of producing dual-circularly polarized beams.

In this paper, the design of an ASK-modulator based on patch antenna-RMSL is presented for point-to-point

microwave link. The proposed ASK-modulator technique addresses the nonlinearity issue with power amplifiers and reduces the complexity and expense of the transmitter. The proposed system can be used in many wireless communication applications including near-field [8], fixed point-to-point microwave link, Radar [23], remote sensing [24], DAM [25] and medical applications [26].

## II. SYSTEM OPERATION

The proposed system basically consists of two components, i.e., a microstrip antenna having a gain of about 1 dBi gain ( $G_t$ ), and a RMSL consisting of  $5 \times 5$  unit cells. The unit cells are controlled by a group of light-dependent resistors (LDR). The RMSL is used to enhance the gain of the microstrip antenna, which is controlled by the activation status of the LDR. If the LDR devices are OFF, the microstrip antenna gain is about 2 dBi, however when LDR devices are ON, the microstrip antenna gain is enhanced to about 13.8 dBi. The resultant gain achieved is thus:

$$G_t = \begin{cases} 2 & \text{dBi status : OFF} \\ 13.8 & \text{dBi status : ON} \end{cases} \quad (1)$$

The gain improvement in the ON state results by the improvement of the impedance matching of the metasurface layer and the increase in the effective aperture area of the antenna. In [27] it's shown how metasurface can change the radiation phase of a patch antenna to an in-phase profile such that the antenna radiates like a planar wave thus enhancing the antenna's performance.

The received power ( $P_r$ ) at the proposed antenna for a fixed point-to-point microwave link is given by Friis transmission equation [28]

$$P_r = P_t + G_r + 20 \log \left( \frac{\lambda}{4\pi R} \right) + \begin{cases} 2 & \text{dBi status : OFF} \\ 13.8 & \text{dBi status : ON} \end{cases} \quad (2)$$

where  $P_t$  is the transmitted power (dB),  $G_r$  is the receiver gain (dBi),  $\lambda$  is the wavelength (m) and  $R$  is the distance between the transmitter and the receiver (m). Equation (2) clearly shows that using the proposed RMSL, the transmitted power can be boosted according to the activation status of the LDR devices. If the RMSL is managed via a data source via a microcontroller, the transmitted power will represent the data. Fig. 1 illustrates the proposed system as an ASK-modulator.

## III. ANTENNA DESIGN

The proposed antenna is based on the design of a standard microstrip patch antenna where the width ( $W$ ) and the length ( $L$ ) can be determined from the following expressions [28]:

$$W = \frac{c}{2f_o} \sqrt{\frac{2}{\epsilon_r + 1}} \quad (3)$$

$$L = \frac{c}{2f_o \sqrt{\epsilon_{eff}}} - 0.824h \left[ \frac{(\epsilon_{eff} + 0.3) \left( \frac{W}{h} + 0.264 \right)}{(\epsilon_{eff} - 0.258) \left( \frac{W}{h} + 0.8 \right)} \right] \quad (4)$$

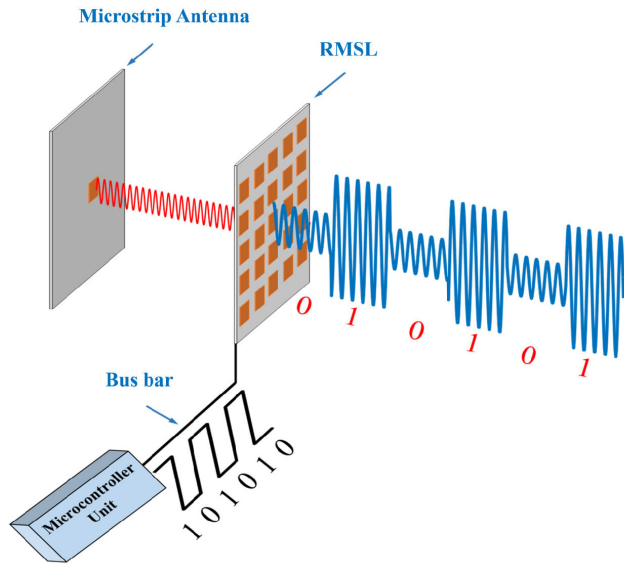

FIGURE 1. System schematic of the proposed ASK modulator.

where

$$\epsilon_{eff} = \frac{\epsilon_r + 1}{2} - \frac{\epsilon_r - 1}{2} \left[ \frac{1}{\sqrt{1 + 12 \frac{h}{W}}} \right] \quad (5)$$

Fig. 2 shows the design of the proposed microstrip antenna at 2.45 GHz, where the patch antenna is directly fed through a coaxial probe of a 50 Ω SMA port. The patch geometry is based on a truncated rectangular structure that was inspired by [29]; however, the patch edges have been etched to create corrugated slots. The purpose for this is to reduce unwanted surface effects that can compromise the antenna’s impedance matching characteristics. It should be noted that the slots have been known to affect the symmetry of the radiation pattern [15]. The FR4 material with  $\epsilon_r = 4.3$ ,  $\tan \delta = 0.025$ , and thickness of 2 mm was chosen to implement the antenna. The corresponding dimensions of the slot in terms of wavelength are as follows: 7.5 mm = 0.061 $\lambda_o$ , 3.5 mm = 0.028 $\lambda_o$ , 4.5 mm = 0.036 $\lambda_o$ , and 1.2 mm = 0.0098 $\lambda_o$  where  $\lambda_o$  is the center frequency. The rectangular groove has a width of 0.008 $\lambda_o$ , larger side length of 0.01 $\lambda_o$  and shorter side length of 0.01 $\lambda_o$ . These values were obtained through optimization using CST Microwave Studio (MWS).

#### IV. RMSL DESIGN

The unit cell, which is shown in Fig. 3, is constructed from microstrip-lines, cross with T-shaped ends also commonly referred to a crutch cross, and U-shaped resonant structures. The motion of the electrical current over the structure is controlled by the four LDR devices which eliminate the limitations of the traditional patches [30]. The LDR devices provide a mechanism to control the antenna gain in both the azimuth and zenith planes. The dimensions of the unit cell are approximately  $\lambda/2$  at the operating frequency according to the criterion given in [31].

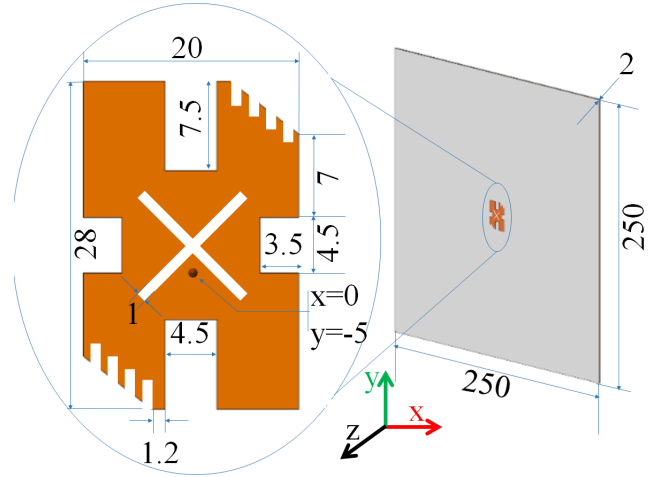

FIGURE 2. Microstrip antenna patch details in millimeter scale.

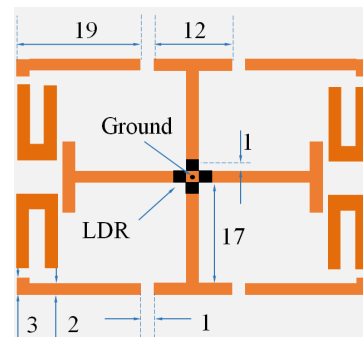
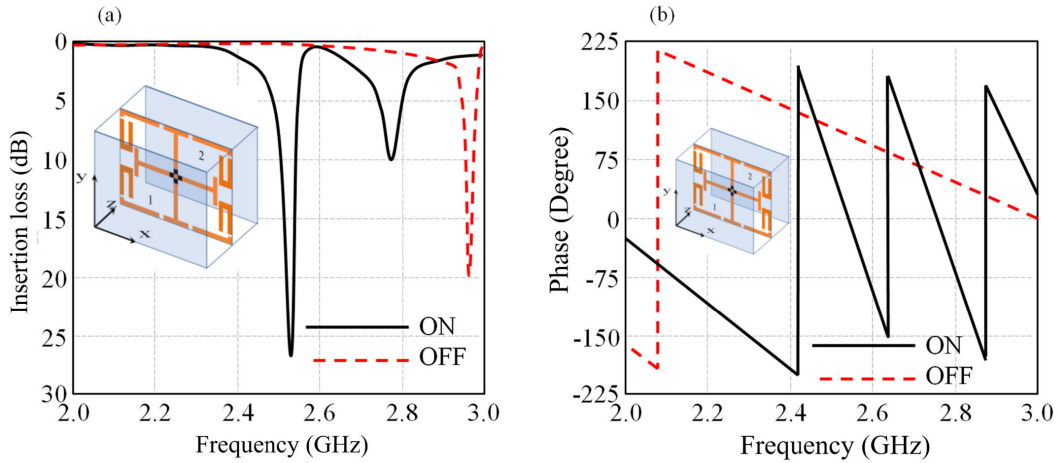

FIGURE 3. Metasurface unit cell structure in millimeter scale.

Electromagnetic characterization of the proposed unit cell was investigated numerically using CST MWS in [32]. To evaluate the constitutive characteristics of the unit cell, it was located at the center of a virtual waveguide, as illustrated in Fig. 4. The top and bottom sides (perpendicular to the y-axis) of the boundary conditions are chosen as Perfect-Magnetic-Conductors (PMC), while the left and right sides are chosen as Perfect-Electric-Conductors (PEC) (perpendicular to x-axis).

According to Fig. 4, two ports along the z-axis are used to stimulate the TEM mode. The magnitude fluctuation of  $S_{21}$  for the ON and OFF situations is depicted in Fig. 4(a). It is important to note that the resonant frequency at Logic-1 was required to be at 2.56 GHz for the given design specifications, however in the case of Logic-0, the frequency resonance is eliminated from the frequency of interest. As a result, only Logic-1 can achieve the maximum power transfer at 2.45 GHz, and Logic-0 results in no power transmission.

The corresponding phase variation of the forward transmission coefficient ( $S_{21}$ ) is plotted in Fig. 4(b) for both ON and OFF states. For the ON case, the matching impedance occurs at the resonant frequency of 2.56 GHz where the phase is 0°. This phenomenon declares that imaginary part of the impedance to vanish, and it confirms that the result



**FIGURE 4.** Unit cell performance characterization, (a)  $S_{21}$  magnitude spectra, and (c)  $S_{21}$  phase response.

of maximum-power-transfer can be obtained at Logic-1 [10]. The ON and OFF states of the LDR determine the sections of the metasurface unit cell structure, shown in Fig. 5, that are connected. In the ON state, the LDR makes the unit cell appear bigger and the corresponding frequency drops, however the vice versa applies when the LDR is in the OFF state.

The transmission-line model in [30] and [33] has been modified to manage the proposed RMSL design. The modifications comprise addition of an extra-capacitance ( $C_{extra}$ ) parallel with the switch ( $S_{extra}$ ), as shown in Fig. 5. When the LDR of the reconfigurable metasurface unit cell is in the OFF state, four new capacitances appear due to the gaps in the reconfigurable metasurface unit cell structure. Therefore,  $C_{extra}$  in Fig. 5 represents the equivalent capacitance of the four capacitances.  $S_{extra}$  represents the four LDR devices. By switching the unit cell to the OFF state, the frequency resonance must vanish from the frequency band of interest. On the other hand, in the ON state, the four LDR devices leads to eliminate the four gaps. In this case, the proposed RMSL provides a well-defined frequency response at 2.56 GHz.

Based on the unit cell's geometrical dimensions, the following equations can be used to calculate the lumped circuit components [33]:

$$C_g \approx \frac{2\epsilon_0\epsilon_{reff}L}{\pi} \left(\frac{L_h}{L}\right) \ln \left[ \frac{1}{\sin\left(\frac{\pi g}{2L}\right)} \right] \quad (6a)$$

$$L_g \approx \frac{\mu_0 L}{2\pi} \left(\frac{L_v}{L}\right) \ln \left[ \frac{1}{\sin\left(\frac{\pi L_2}{2L}\right)} \right] \quad (6b)$$

$$\epsilon_{reff} = \frac{\epsilon_r + 1}{2} + \frac{\epsilon_r - 1}{2} \left\{ \left[ 1 + 12 \left(\frac{h}{w}\right) \right]^{-0.5} + \left[ 1 - \left(\frac{w}{h}\right) \right]^2 \right\} \quad (6c)$$

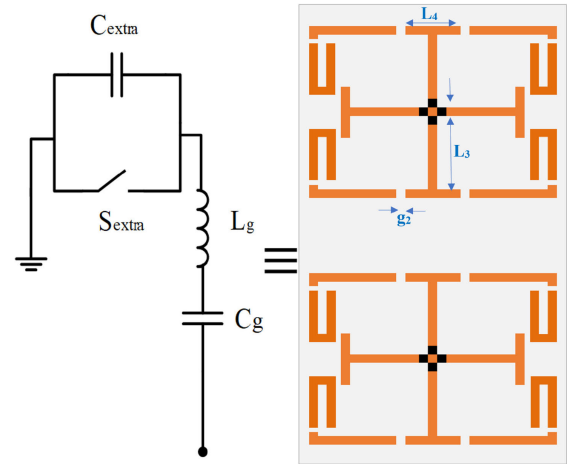

**FIGURE 5.** The equivalent circuit of the proposed RMSL.

where  $L_g$  is the total inductance of the metasurface layer, and  $C_g$  is the total capacitance of the metasurface layer, which is mostly due to the fringing capacitance. The substrate thickness and microstrip-line width are represented by  $h$  and  $w$ . The gap between the two neighboring unit cell's and between the center and edges, respectively, are represented by  $L$  and  $g$ . Lengths  $L_h = 2L_3 + L_4$  and  $L_v = 2L_3 + g_2$ . For a very thin metasurface substrate,  $\epsilon_{reff}$  can be assumed to equate to unity from equation (6c). From the equivalent circuit model given in Fig. 5, the resonance frequency  $f_r$  can be obtained using the following expression [33]:

$$f_r = \frac{1}{2\pi} \sqrt{\frac{C_g + C_{extra}}{C_g C_{extra} L_g}} \quad (7)$$

For the ON state, the calculated equivalent circuit parameters are as follows:  $C_g = 0.1953\text{pF}$ ,  $L_g = 21.241\text{nH}$  and  $f_r = 2.47\text{ GHz}$ . For the OFF state,  $C_{extra}$  appears in series with  $C_g$  which results in reducing the value of equivalent



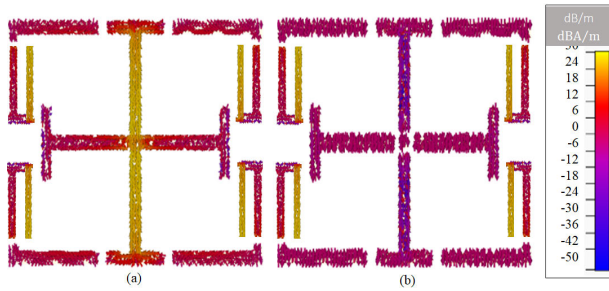

FIGURE 6. Surface current distributions of the proposed unit cell; (a) status-ON; (b) status-OFF.

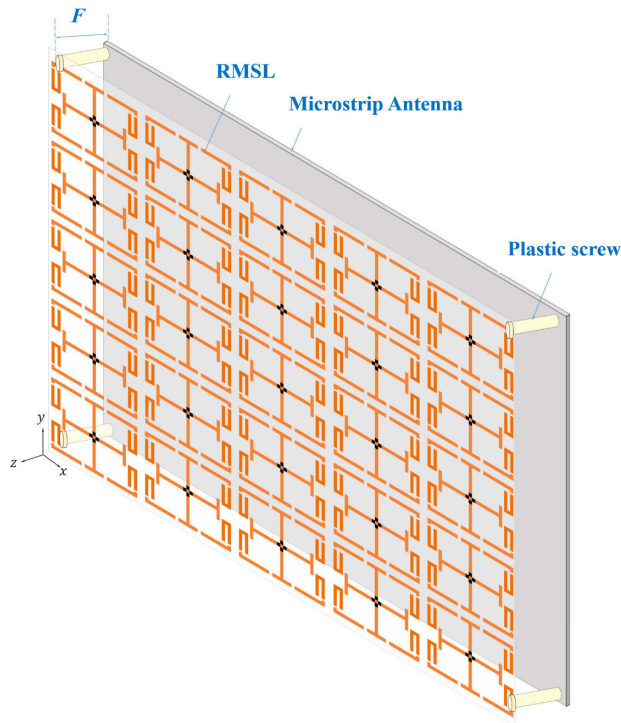

FIGURE 7. The proposed RMSL structure.

capacitance and shift-up the resonance frequency. A small capacitance value of  $C_{extra}$  is expected by considering the physical gap. In fact,  $C_{extra}$  has a value of 0.08pF and as a result, the resonance frequency  $f_r$  shifts up in frequency to 4.4 GHz.

The surface current distributions over the proposed metasurface unit cell structure in the ON and OFF LDR states are shown in Fig. 6. The surface current over the antenna structure is due to the flow of electrical charge over the antenna structure. The non-uniform distribution of surface current is due to the changing electromagnetic field impinging on the antenna and the interaction between the adjacent metasurface unit cells. Nevertheless, in the case of ON state, the surface current distribution reaches a maximum magnitude of 29 dBA/m, as shown in Fig. 6(a), at a resonance frequency of 2.45 GHz.

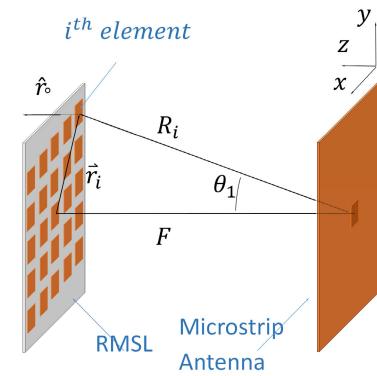

FIGURE 8. Ray-tracing based phase difference.

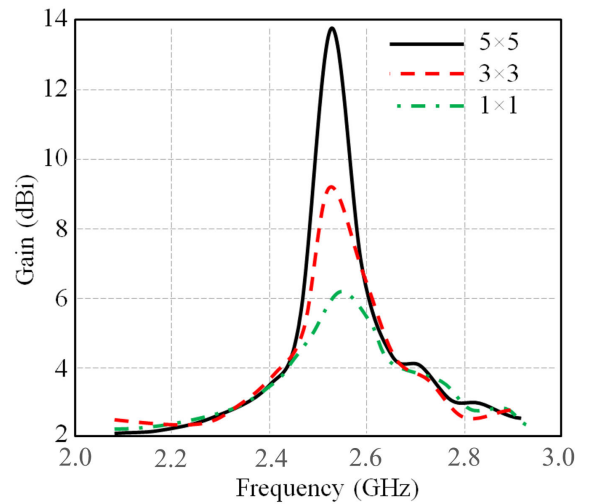
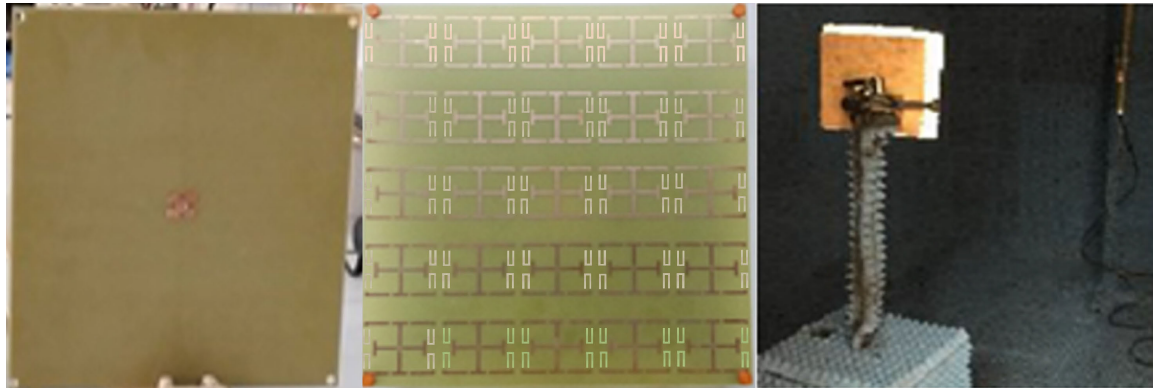

FIGURE 9. A parametric study for the proposed system performance.

In the OFF state, the surface current distribution is observed to be around 0 dBA/m, as shown in Fig. 6(b).

The proposed RMSL is based on an array of  $5 \times 5$  cells distributed uniformly. The RMSL that is constructed from the proposed unit cell is mounted on a FR4 substrate ( $\epsilon_r = 4.3, \tan \delta = 0.025$ ) with a thickness of 1 mm. The dimensions of the individual unit cell are  $50 \times 50 \text{ mm}^2$  where outer physical dimensions of the conductor region are  $45 \times 36 \text{ mm}^2$  and the space between the conductors of neighbor unit cells are 10 mm and 14 mm along x- and y-axes, respectively. To ensure minimum coupling between the unit cells, the periodicity of the unit cell was adjusted to 50 mm ( $\sim \lambda/2$ ) [31]. A perspective view of the proposed antenna and RMSL structure is shown in Fig. 7.

One of the key points in the design of the RMSL was the determination of focal length ( $F$ ) under ON and OFF LDR states. While optimal gain may be obtained when the distance between the RMSL and the antenna is set to achieve the paraxial rays, proper focal length selection is essential. The unit cell in the ON and OFF scenarios has a distinct focal length. We achieved the greatest increase in antenna gain when RMSL was placed at the focus point. When the RMSL



**FIGURE 10.** The fabricated prototypes and measurement setup. From left to right: Fabricated microstrip antenna, top view of the RMSL, and antenna measurement setup inside the RF anechoic chamber.

was switched to the OFF state, the focal length changes to a different value and the antenna gain drops. The gap between the RMSL and antenna was held constant in this study.

In this work, two methods are introduced to find the value of the focal point. The first approach uses ray-tracing analysis, which was motivated by optical theory in [34]. The authors performed the necessary computations while imagining the metasurface layer as a lens mounted antenna to investigate the basic workings of the layer. The RMSL's dimensions were kept the same as the ground plane of the microstrip antenna to reduce the side-lobe levels. Moreover, the phase difference between the central unit cell and the diagonal unit cell on the metasurface layer were made to be  $(2n + 1)\pi$  rad ( $n$  is an integer). This condition is necessary to guarantee the maximum possible deconstructive interference of the radiated electromagnetic waves from the layer's unit cells at the rim. From the illustrated in Fig. 8 it can be shown that the phase difference is given by [35].

$$k \left[ R_i - \left( \vec{r}_i \cdot \hat{r}_0 \right) \right] = \psi_i - \psi_0 \quad (8)$$

where  $k$  is the propagation constant in free space. The distance from the center of the patch antenna to the center of the  $i^{\text{th}}$  element is represented by  $R_i$ , and  $\vec{r}_i$  is the position vector of the  $i^{\text{th}}$  element. The direction vector of the main beam is  $\hat{r}_0$ . To meet this condition, the term  $\psi_i - \psi_0$  must be adjusted to be  $3\pi$  rad. The other clue at the broadside direction is that both  $\vec{r}_i$  and  $\hat{r}_0$  are almost perpendicular, which means that the dot product between  $\vec{r}_i$  and  $\hat{r}_0$  is null. Therefore, the value of  $R_i$  is found to be 153 mm,  $\theta_1 = 67.6^\circ$ . RMSL is mounted at a focal point ( $F$ ) distance of 70 mm.

Based on CST MWS simulations, the second approach is determined by the focal length. To achieve the greatest gain increase, CST MWS is used to investigate the ideal metasurface placement, array size, and orientation of the microstrip patch antenna. By changing the reconfigurable metasurface array configuration size from  $1 \times 1$ ,  $3 \times 3$ , and  $5 \times 5$ , the antenna gain is found to change significantly as shown in Fig. 9.

## V. MEASUREMENTS AND VALIDATION

The antenna and RMSL were constructed and installed, as shown in Fig. 10, following the determination of the ideal system design parameters. Chemical etching using PCB technology is used to create the antenna and RMSL. Four plastic screws, each measuring 70 mm in length, are used to install the RMSL. It is important to note that LDR are not soldered while making RMSL. Instead, two distinct layers are constructed to show the ON and OFF states. A common measuring system is used to assess the antenna performance in terms of  $S_{11}$  spectra and radiation patterns. Coaxial cables, an Agilent PNA 8720 series vector network analyzer, and an 82357A USB to GPIB interface that is linked to an external computer make up the measurement setup. As shown in Fig. 10, the antenna is mounted on a rotating holder which is located inside an RF anechoic chamber.

The simulated and measured  $S_{11}$  variation as the function of frequency and the antenna radiation pattern at  $\varphi = 0^\circ$  and  $\varphi = 90^\circ$  planes are shown in Fig. 11. Fig. 11(a) shows  $S_{11}$  of the antenna without RMSL. It is observed from this figure that the antenna radiation pattern covers a wide 3-dB beamwidth of  $136^\circ$  with a gain of about 1 dBi at 2.45 GHz. The spectra of  $S_{11}$  for the antenna with RMSL in the OFF state is shown in Fig. 11(b) together with radiation patterns at perpendicular planes. The antenna resonates frequency at 2.45 GHz with a gain of about 2 dBi and exhibits a 3-dB beamwidth of  $113^\circ$ . The final set of measurements is presented in Fig. 11(c) for the antenna with RMSL in the ON state. It is found from this figure that the antenna exhibits a gain of about 13.8 dBi at 2.45 GHz. In this case, the antenna's 3-dB beamwidth is significantly reduced to  $26^\circ$ .

Total efficiency of the antennas was investigated in this study. The total efficiency of the antenna was 20% when RMSL is not employed. However, by assembling the RMSL on the microstrip antenna, the total efficiency improved to 28% in the OFF state but in the ON state the efficiency significantly increased to 45%. The reason for the improvement in total efficiency in the ON state is because the reactive part of the RMSL at its resonance frequency, i.e., operating

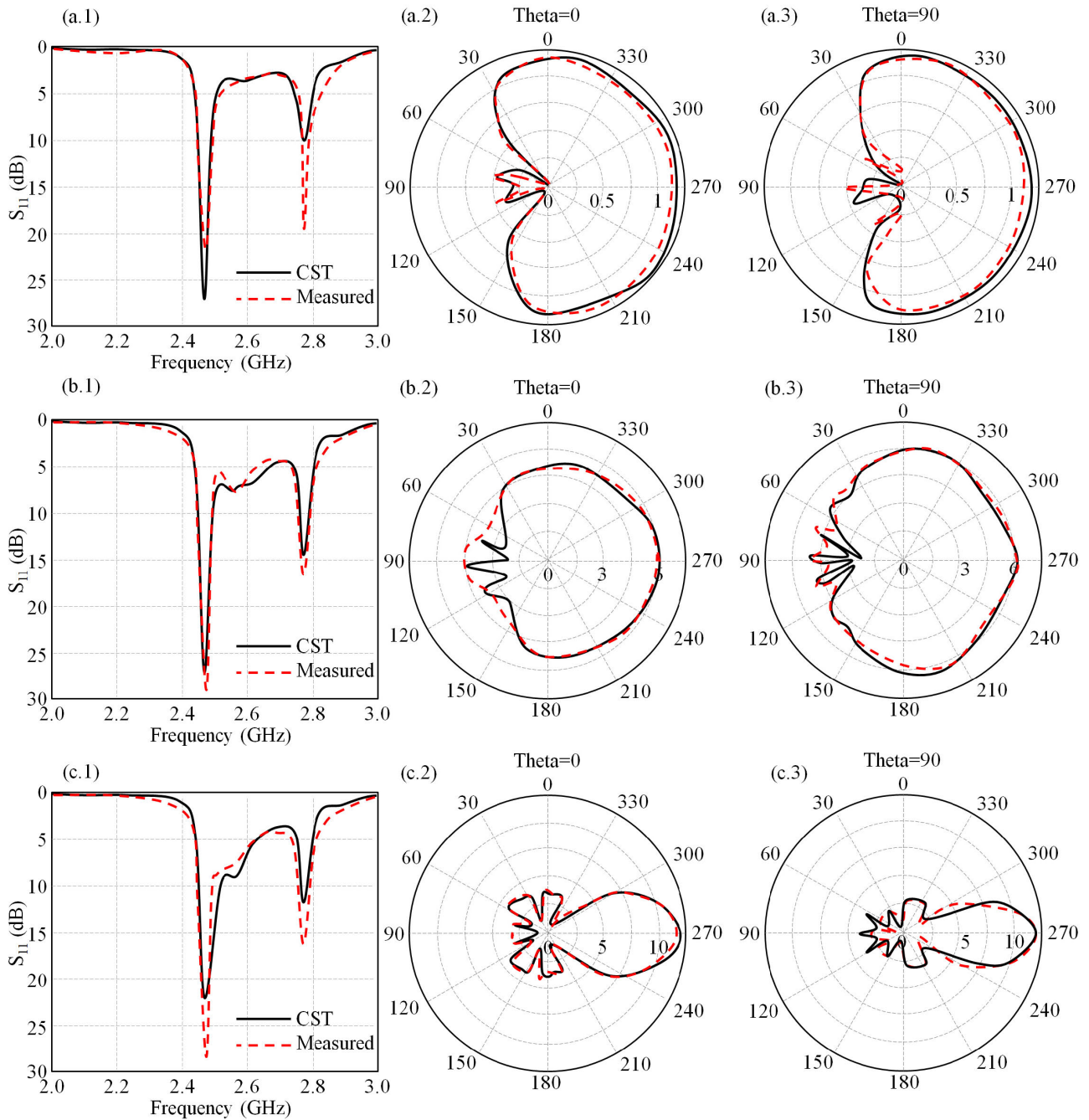

**FIGURE 11.** Measured and simulated results of the proposed antennas, (a.1)  $S_{11}$  spectra of the antenna without RMSL, (a.2), and (a.3) radiation pattern of the antenna without the RMSL at  $\varphi = 0^\circ$  and  $\varphi = 90^\circ$ , respectively, (b.1)  $S_{11}$  spectra of the antenna with RMSL in the OFF state, (b.2), and (b.3) radiation pattern of the antenna with RMSL in the OFF state at  $\varphi = 0^\circ$  and  $\varphi = 90^\circ$ , respectively, (c.1)  $S_{11}$  spectra of the antenna with RMSL in the ON state, (c.2), and (c.3) radiation pattern of the antenna with RMSL in the ON state at  $\varphi = 0^\circ$  and  $\varphi = 90^\circ$ , respectively.

frequency, is negated. Hence, optimum power is transferred through the RMSL.

RMSL does not have the same symmetry along  $x$  and  $y$ -planes. Thus, to observe the effects of RMSL placement on the antenna performance, RMSL is rotated  $90^\circ$  with respect to the microstrip antenna on  $x - y$  plane around its center. The antenna parameters are listed in Table 1 for non-rotated and

$90^\circ$ -rotated cases. When the RMSL is rotated  $90^\circ$ , the antenna gain obtained is 2.6 dBi and 10 dBi for the OFF and ON states, respectively. The difference in the gain between the ON and OFF states is 7.4 dB. An optimum gain of 9 dB was obtained at  $0^\circ$  orientation. Therefore,  $0^\circ$  orientation was chosen as the optimal case. The simulated antenna gain was 11.8 dB. The discrepancy between the measured and simulated results is

**TABLE 1.** Effects of RMSL rotation on the antenna performance.

At orientation = 0°						
status	$f_r$ (GHz)	$S_{11}$ (dB)	Gain (dBi)	F/B (dB)	Total efficiency (%)	Radiation efficiency (%)
OFF	2.45	-24	2	7.5	28	29
ON	2.45	-21	13.8	5.2	44	45
At orientation = 90°						
status	$f_r$ (GHz)	$S_{11}$ (dB)	Gain (dBi)	F/B (dB)	Total efficiency (%)	Radiation efficiency (%)
OFF	2.45	-25	2.3	7.4	28	29
ON	2.45	-20	13.6	6.5	39	39

**TABLE 2.** Comparison of the proposed work with other published results.

Reference	$f_r$ (GHz)	Substrate	Size (mm <sup>2</sup> )	Number of layers	Gain enhancement (G) (dB)
[15]	2.45	FR4	240 × 240	2 layers	5.1
[35]	2.65	Taconic	360 × 360	2 layers (Octagon)	7.8
[36]	5.8	FR4	50 × 50	1 layer	1.2
[37]	11.38	Polymer	50 × 50	1 layer	7.9
[38]	5.2	FR4	50 × 50	1 Layer	4.5
[39]	2.65	Taconic	360 × 360	2 layers (circular)	6.0
proposed work	2.45	FR4	250 × 250	1 layer	9.0

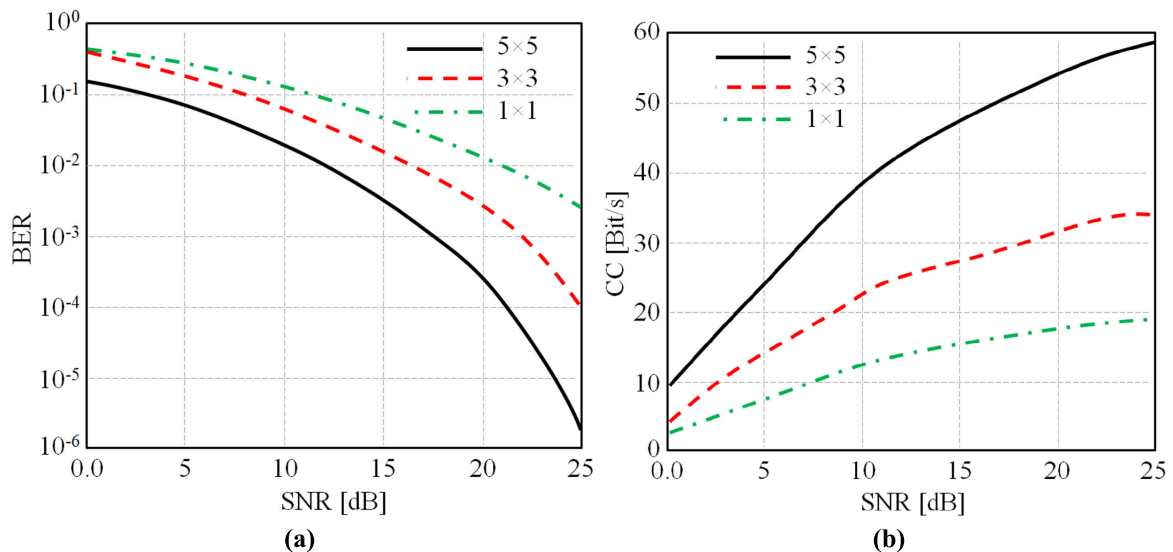
**FIGURE 12.** Channel performance: (a) BER for 12 bits/s/Hz, and (b) CC evaluations.

attributed to manufacturing tolerance and the inaccuracy of the simulation models. Front-to-back ratio (F/B) change is insignificant by the orientation of the RMSL.

Previous antenna research has essentially paid attention to improving the antenna gain. The performance of the proposed antenna is compared with other published works in Table 2. It is evident from the table that the proposed antenna exhibits exceptional gain improvement resulting from the use of the reconfigurable RMSL. In this work, the application intended for the proposed antenna is for controlling the antenna gain required direct antenna modulation schemes. According to

authors' knowledge, the proposed work is the first of its kind on intelligent metasurface layer for amplitude modulation technology.

## VI. CHANNEL PERFORMANCE RESULTS

In this section, the proposed antenna system is evaluated in terms of bit error rate (BER) and channel capacity (CC). ASK schema was applied to the antenna directly by reconfiguring the RMSL. This was achieved by switching the status of the LDR devices. The BER performance was determined at various signal-to-noise ratios (SNR) and in the ON/OFF



LDR scenarios. In the MATLAB computation Additive white Gaussian noise (AWGN) was considered. The maximum BER is placed at 100 and the maximum number of bits is taken as  $1 \times 10^7$ . The BER behavior as a function of S/N and RMSL array size is shown in Fig. 12(a). The performance of the proposed antenna system in terms of CC as a function of S/N and RMSL array size is shown in Fig. 12(b). It was discovered that significant variation in CC could occur with changing the switching scenarios at the frequency band of interest.

## VII. CONCLUSION

Proposed here is an ASK transmitter system based on microstrip antenna and RMSL for point-to-point microwave link. When the RMSL is turned on (Logic-1), the proposed antenna system offers a gain of 13.8 dBi. However, when the RMSL is turned off (Logic-0), the gain only reaches 2 dBi in relation to cycles of the modulation period. Digital coding can regulate the transmitted electromagnetic power from the proposed antenna system by electrically switching each unit cell in the RMSL. The operating principle is explained using an analogous circuit model and optical ray-tracing analysis. By changing the metasurface layer, the antenna gain can be controlled. The antenna system was practically evaluated. The measured findings show excellent agreement with the numerical predictions. Rotating the RMSL in relation to the microstrip antenna around its center allowed one to see how the positioning of the RMSL affects the antenna's performance. It was discovered that the radiation pattern and gain could be significantly altered by  $90^\circ$  rotation of the metasurface layer with respect to the patch antenna's normal axis. It was discovered that when the RMSL is switched to the OFF state, the surface current over the structure is reduced and vice-versa in the ON state. The phase variation of the forward transmission coefficient shows impedance matching at the resonant frequency at the ON state. In this case, the phase is zero and the imaginary part of the impedance is negligible. As a result, maximum power transfer is obtained at Logic-1. Finally, the efficiency of the antenna system was found to be significantly enhanced by switching the RMSL to the ON state. This was because the reactive component of the antenna is negated at its resonance frequency. As a future work, the proposed RMSL structure needs to be analyzed using different modulation processes. Also, investigation needs to be conducted to realize beam splitting for space division multiple access applications.

## REFERENCES

- [1] I. Glover and P. Grant, "Bandpass modulation of a carrier signal," in *Digital Communications*, 3rd ed. London, U.K.: Prentice-Hall, 2010, pp. 390–449.
- [2] S. Henthorn, K. L. Ford, and T. O'Farrell, "Bit-error-rate performance of quadrature modulation transmission using reconfigurable frequency selective surfaces," *IEEE Antennas Wireless Propag. Lett.*, vol. 16, pp. 2038–2041, 2017.
- [3] V. F. Fusco and Q. Chen, "Direct-signal modulation using a silicon microstrip patch antenna," *IEEE Trans. Antennas Propag.*, vol. 47, no. 6, pp. 1025–1028, Jun. 1999.
- [4] W. Yao and Y. Wang, "Direct antenna modulation—A promise for ultra-wideband (UWB) transmitting," in *IEEE MTT-S Int. Microw. Symp. Dig.*, Jun. 2004, pp. 1273–1276.
- [5] X. Jessie Xu and Y. E. Wang, "A direct antenna modulation (DAM) transmitter with a switched electrically small antenna," in *Proc. Int. Workshop Antenna Technol. (iWAT)*, Lisbon, Portugal, Mar. 2010, pp. 1–4.
- [6] S. D. Keller, W. D. Palmer, and W. T. Joines, "Switched antenna circuit with increased information bandwidth," *IEEE Antennas Wireless Propag. Lett.*, vol. 9, pp. 1045–1048, 2010.
- [7] A. Ourir, K. Rachedi, D.-T. Phan-Huy, C. Leray, and J. de Rosny, "Compact reconfigurable antenna with radiation pattern diversity for spatial modulation," in *Proc. 11th Eur. Conf. Antennas Propag. (EUCAP)*, Mar. 2017, pp. 3038–3043, doi: 10.23919/EuCAP.2017.7928562.
- [8] A. Babakhani, D. B. Rutledge, and A. Hajimiri, "Transmitter architectures based on near-field direct antenna modulation," *IEEE J. Solid-State Circuits*, vol. 43, no. 12, pp. 2674–2692, Dec. 2008.
- [9] D. Park, M. Kim, and D.-H. Cho, "Novel single-RF MIMO system based on repetitive pulse width modulation," *IEEE Commun. Lett.*, vol. 20, no. 1, pp. 165–168, Jan. 2016.
- [10] M. Manteghi, "A wideband electrically small transient-state antenna," *IEEE Trans. Antennas Propag.*, vol. 64, no. 4, pp. 1201–1208, Apr. 2016.
- [11] S. Henthorn, K. L. Ford, and T. O'Farrell, "Frequency selective surface loaded antenna for direct antenna modulation," in *Proc. 11th Eur. Conf. Antennas Propag. (EUCAP)*, Paris, France, Mar. 2017, pp. 731–734.
- [12] T. J. Cui, S. Liu, G. D. Bai, and Q. Ma, "Direct transmission of digital message via programmable coding metasurface," *Research*, vol. 2019, pp. 1–12, Jan. 2019, doi: 10.34133/2019/2584509.
- [13] K. Chen, Y. Feng, F. Monticone, J. Zhao, B. Zhu, T. Jiang, L. Zhang, Y. Kim, X. Ding, S. Zhang, A. Alù, and C. Qiu, "A reconfigurable active Huygens' metalens," *Adv. Mater.*, vol. 29, no. 17, Feb. 2017, Art. no. 1606422.
- [14] Y. Alnaiey, T. A. Elwi, and N. Lajos, "Enhancing the microstrip antenna gain using a novel EBG lens based on a single layer," in *Proc. 11th Int. Symp. Commun. Syst., Netw. Digit. Signal Process. (CSNDSP)*, Budapest, Hungary, 2018, pp. 1–4, doi: 10.1109/CSNDSP.2018.8471786.
- [15] Y. Alnaiey, T. A. Elwi, N. Lajos, and T. Zwick, "A systematic analysis and design of a high gain microstrip antenna based on a single FSS layer," *Infocommun. J.*, vol. 10, pp. 1–9, Dec. 2018.
- [16] T. Kodera, "Smart metasurface with non-reciprocity for fog layer in IoT environment," in *Proc. IEEE Int. Symp. Electromagn. Compat. IEEE Asia-Pacific Symp. Electromagn. Compat. (EMC/APEMC)*, Singapore, May 2018, pp. 912–914.
- [17] L. Liu, L. Kang, T. S. Mayer, and D. H. Werner, "Hybrid metamaterials for electrically triggered multifunctional control," *Nature Commun.*, vol. 7, no. 1, p. 13236, Oct. 2016.
- [18] P. Hosseini, C. D. Wright, and H. Bhaskaran, "An optoelectronic framework enabled by low-dimensional phase-change films," *Nature*, vol. 511, no. 7508, pp. 206–211, Jul. 2014.
- [19] L. Bao, X. Fu, R. Y. Wu, Q. Ma, and T. J. Cui, "Full-space manipulations of electromagnetic wavefronts at two frequencies by encoding both amplitude and phase of metasurface," *Adv. Mater. Technol.*, vol. 6, no. 4, Apr. 2021, Art. no. 2001032, doi: 10.1002/admt.202001032.
- [20] S. J. Li, Z. Y. Li, G. S. Huang, X. B. Liu, R. Q. Li, and X. Y. Cao, "Digital coding transmissive metasurface for multi-OAM-beam," *Frontiers Phys.*, vol. 17, no. 6, p. 62501, Dec. 2022, doi: 10.1007/s11467-022-1179-9.
- [21] H. Almizan, M. H. Jwair, Y. Al Naiemy, Z. A. A. Hassain, L. Nagy, and T. A. Elwi, "Novel metasurface based microstrip antenna design for gain enhancement RF harvesting," *Infocommun. J.*, vol. 15, no. 1, pp. 2–8, 2023.
- [22] S. J. Li, B. W. Han, Z. Y. Li, X. B. Liu, G. S. Huang, R. Q. Li, and X. Y. Cao, "Transmissive coding metasurface with dual-circularly polarized multi-beam," *Opt. Exp.*, vol. 30, no. 15, p. 26362, Jul. 2022, doi: 10.1364/OE.466036.
- [23] G. Kizer, *Digital Microwave Communication: Engineering Point-to-Point Microwave Systems*. Hoboken, NJ, USA: Wiley, 2013.
- [24] C. Elachi and J. J. Van Zyl, *Introduction to the Physics and Techniques of Remote Sensing*. New York, NY, USA: Wiley, 2006.
- [25] G. I. Kiani and T. S. Bird, "ASK modulator based on switchable FSS for THz applications," *Radio Sci.*, vol. 46, no. 2, pp. 1–8, Apr. 2011.
- [26] F. S. Barnes and B. Greenebaum, *Bioengineering and Biophysical Aspects of Electromagnetic Fields*, 3rd ed. Boca Raton, FL, USA: Taylor & Francis, 2007.

- [27] K. Chen, Z. Yang, Y. Feng, B. Zhu, J. Zhao, and T. Jiang, "Improving microwave antenna gain and bandwidth with phase compensation metasurface," *AIP Adv.*, vol. 5, no. 6, pp. 1–8, Jun. 2015.
- [28] C. A. Balanis, *Antenna Theory: Analysis and Design*, 4th ed. Hoboken, NJ, USA: Wiley, 2016.
- [29] H. Almizan, T. A. Elwi, and Z. A. A. Hassain, "Circularly-polarized, wide-range coverage azimuth and elevation angles microstrip antenna for RF harvesting," *J. Eng. Sustain. Develop.*, vol. 24, pp. 191–198, Aug. 2020.
- [30] M. Hosseini and S. V. Hum, "A circuit-driven design methodology for a circular polarizer based on modified Jerusalem cross grids," *IEEE Trans. Antennas Propag.*, vol. 65, no. 10, pp. 5322–5331, Oct. 2017.
- [31] M. Haleem and T. A. Elwi, "Circularly polarized metamaterial patch antenna circuitry for modern applications," *Far East J. Electron. Commun.*, vol. 26, pp. 17–32, Dec. 2022, doi: [10.17654/0973700622003](https://doi.org/10.17654/0973700622003).
- [32] *CST Microwave Studio*. Accessed: May 28, 2018. [Online]. Available: <http://www.cst.com>
- [33] H. Almizan, Z. A. A. Hassain, T. A. Elwi, and S. M. Al-Sabti, "Controlling gain enhancement using a reconfigurable metasurface layer," in *Proc. 12th Int. Symp. Adv. Topics Electr. Eng. (ATEE)*, Bucharest, Romania, Mar. 2021, pp. 1–6, doi: [10.1109/ATEE52255.2021.9425037](https://doi.org/10.1109/ATEE52255.2021.9425037).
- [34] A. H. Abdelrahman, F. Yang, A. Z. Elsherbeni, and P. Nayeri, "Space-fed array design method," in *Analysis and Design of Transmitarray Antennas*, 1st ed. San Rafael, CA, USA: Morgan Claypool, 2017, pp. 7–8.
- [35] T. A. Elwi, H. M. Al-Rizzo, D. G. Rucker, and F. Song, "Numerical simulation of a UC-PBG lens for gain enhancement of microstrip antennas," *Int. J. RF Microw. Comput.-Aided Eng.*, vol. 19, no. 6, pp. 676–684, Nov. 2009, doi: [10.1002/mmce.20391](https://doi.org/10.1002/mmce.20391).
- [36] Y. Che, X. Hou, and P. Zhang, "Design of multiple FSS screens with dissimilar periodicities for directivity enhancement of a dual-band patch antenna," in *Proc. 9th Int. Symp. Antennas, Propag. EM Theory*, Guangzhou, China, Nov. 2010, pp. 319–322.
- [37] A. Pirhadi, H. Bahrami, and J. Nasri, "Wideband high directive aperture coupled microstrip antenna design by using a FSS superstrate layer," *IEEE Trans. Antennas Propag.*, vol. 60, no. 4, pp. 2101–2106, Apr. 2012.
- [38] A. Mellita, D. S. Chandu, and S. S. Karthikeyan, "Gain enhancement of a microstrip patch antenna using a novel frequency selective surface," in *Proc. 23rd Nat. Conf. Commun. (NCC)*, Chennai, India, Mar. 2017, pp. 1–4.
- [39] T. A. Elwi, H. M. Al-Rizzo, N. Bouaynaya, M. M. Hammood, and Y. Al-Naiemy, "Theory of gain enhancement of UC-PBG antenna structures without invoking Maxwell's equations: An array signal processing approach," *Prog. Electromagn. Res. B*, vol. 34, pp. 15–30, 2011.



**MARWAH HALEEM JWAIR** was born in Baghdad, Iraq, in 1986. She received the bachelor's and master's degrees in information engineering college from AL-Nahrain University, Baghdad, Iraq, in 2016 and 2018, respectively, where she is currently pursuing the Ph.D. degree since 2021. Her main research interests are in antennas, microwave devices, analog and digital electronics.

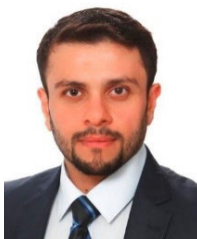

**TAHAA A. ELWI** received the B.Sc. degree (Hons.) from the Department of Electrical Engineering, Nahrain University, Baghdad, Iraq, in 2003, the M.Sc. degree (Hons.) from the Department of Laser and Optoelectronics Engineering, Nahrain University, in 2005, and the Ph.D. degree in system engineering and science from the University of Arkansas at Little Rock, in 2011. From April 2005 to August 2007, he was with Huawei Technologies Company, Baghdad. His research interests include wearable and implantable antennas for biomedical wireless systems, smart antennas, WiFi deployment, electromagnetic wave scattering by complex objects, design, modeling, and testing of metamaterial structures for microwave applications, design and analysis of microstrip antennas for mobile radio systems, precipitation effects on terrestrial and satellite frequency re-use communication systems, and effects of the complex media on electromagnetic propagation and GPS. The nano-scale structures in the entire electromagnetic spectrum are a part of his research interest.



**MOHAMMAD ALIBAKHSHIKENARI** (Member, IEEE) was born in Mazandaran, Iran, in February 1988. He received the Ph.D. degree (Hons.) with European Label in electronics engineering from the University of Rome Tor Vergata, Italy, in February 2020. From May 2018 to December 2018, he was a Ph.D. Visiting Researcher with the Chalmers University of Technology, Sweden. His training during the Ph.D. research included a research stage with Swedish

Company Gap Waves AB, Gothenburg. Since July 2021, he has been with the Department of Signal Theory and Communications, Universidad Carlos III de Madrid (uc3m), Spain, as a Principal Investigator of the CONnecting Excellence (CONEX)-Plus Talent Training Program and Marie Skłodowska-Curie Actions. From 2021 to 2022, he was also a Lecturer with the Electromagnetic Fields and Electromagnetic Laboratory, Department of Signal Theory and Communications. His research interests include electromagnetic systems, antennas and wave-propagations, metamaterials and metasurfaces, sensors, synthetic aperture radars (SAR), 5G and beyond wireless communications, multiple input multiple output (MIMO) systems, RFID tag antennas, substrate integrated waveguides (SIWs), impedance matching circuits, microwave components, millimeter-waves and terahertz integrated circuits, gap waveguide technology, beamforming matrix, and reconfigurable intelligent surfaces (RIS), which led to achieve more than 4200 citations and H-index above 42 reported by Scopus, Google Scholar, and ResearchGate. He was a recipient of the three years Principal Investigator research grant funded by the Universidad Carlos III de Madrid and the European Union's Horizon 2020 Research and Innovation Program under the Marie Skłodowska-Curie Grant, in July 2021, the two years research grant funded by the University of Rome Tor Vergata started, in November 2019, the three years Ph.D. Scholarship funded by the University of Rome Tor Vergata started, in November 2016, and the two Young Engineer Awards of the 47th and 48th European Microwave Conference held in Nuremberg, Germany, in 2017, and Madrid, Spain, in 2018, respectively. He also received the "Teaching Excellent Acknowledgement" Certificate for the course of electromagnetic fields from the Vice-Rector of Studies of uc3m. From December 2022 to May 2023, he spent three industrial and academic research visits in SARAS Technology Ltd. Company, Leeds, U.K.; Edinburgh Napier University, Edinburgh, U.K.; and the University of Bradford in West Yorkshire, U.K., which were defined by CONEX-Plus Talent Training Program and Marie Skłodowska-Curie Actions as his secondment research visit plans. In April 2020, his research article entitled "High-Gain Metasurface in Polyimide On-Chip Antenna Based on CRLH-TL for Sub Terahertz Integrated Circuits" published in Scientific Reports was awarded as the Best Month Paper from the University of Bradford, West Yorkshire, U.K. He is serving as an Associate Editor for *Radio Science* and *IET Journal of Engineering*. He also acts as a referee in several highly reputed journals and international conferences.



**BAL S. VIRDEE** (Senior Member, IEEE) received the B.Sc. and M.Phil. degrees in communications engineering from the University of Leeds, U.K., and the Ph.D. degree in electronic engineering from the University of London, U.K. He has worked in the industry for various companies, including Philips, U.K., as a Research and Development Engineer and Teledyne Defence and Space, Shipley, U.K., as a Future Products Design Engineer in RF/microwave communications systems. He has taught at several academic institutions in the U.K., before joining London Metropolitan University, where he is currently a Senior Professor of communications technology with the School of Computing and Digital Media and the Director of the Center for Communications Technology. His research, in collaboration with industry and academia, is in the area of microwave/millimeter-wave/terahertz wireless communications encompassing mobile phones to satellite technology. He has chaired numerous technical sessions at IEEE international conferences and published numerous research papers. He is the Chair and an Executive Member of IET's Technical and Professional Network Committee on RF/Microwave Technology. He is a fellow of IET and a Chartered Engineer of IEEE. He is also a Senior Fellow of the Higher Education Academy.





**HAYDER ALMIZAN** received the B.S. degree in electrical engineering from the University of Kufa, Najaf, Iraq, in 2008, and the Higher Diploma degree in aerospace engineering from the Sapienza University of Rome, Rome, Italy, in 2014. He is currently pursuing the M.Sc. degree in electronics and communications engineering with Mustansiriyah University, Baghdad, Iraq. From 2009 to 2012, he worked at the Consultant Engineering Department of Kufa University. Since 2014, he has

been joined the Electronics and Communications Engineering Department, Kufa University. His recent research interests include signal processing, neural network, numerical techniques for electromagnetic engineering of metamaterials and artificial structures.



**ZAID A. ABDUL HASSAIN** was born in Baghdad, Iraq, in 1979. He received the B.Eng. degree in electrical engineering from Mustansiriyah University, Baghdad, in 2000, and the master's degree in engineering science, in 2002. He is currently a Professor and the Director of Antenna and Microwave with the Department of Electrical Engineering, Mustansiriyah University.



**SYED MANSOOR ALI** received the Ph.D. degree in physics from The Islamia University of Bahawalpur, Pakistan, in 2014. Since September 2012, he has been a Researcher with the Department of Physics and Astronomy, College of Science, King Saud University, Riyadh, Saudi Arabia. His research specialization in materials science includes radiation interaction with nanomaterials for radiation and energy conversion/storage applications. His research interests include various

heterostructure junction fabrication and simulation for the application of perovskite solar cells, supercapacitors, and radiation sensors/detectors.



**LIDA KOUHALVANDI** (Senior Member, IEEE) received the B.Sc. degree in electronics engineering from the Azad University of Tabriz, Tabriz, Iran, in 2011, the M.Sc. and Ph.D. degrees in electronics engineering from Istanbul Technical University, Istanbul, Turkey, in 2015 and 2021, respectively, and the Ph.D. (Hons.), joined the Department of Electrical and Electronics Engineering at Dogus University as an Assistant Professor in October 2021. She took possession of an

Associate Professor degree, in February 2023. In recognition of her research, she received the Doctoral Fellowship from the Department of Electronics and Telecommunications, Politecnico di Torino, Turin, Italy, from 2019 to 2020, where she joined as a Research Fellowship, from February 2021 to July 2021 and also from May 2022 to May 2023. She also has experience in computer-aided designs and optimization algorithms through machine learning. Her research interests include radio frequency and analog engineer are power amplifiers, antenna, analog designs, and implantable medical devices. She received the Best Paper Award from EExPolytech-2021: Electrical Engineering and Photonics Conference, in 2021. Her Ph.D. thesis was accepted for presentation at the Ph.D. Forum of the 2021 IEEE/ACM Design Automation Conference (DAC 2021) in San Francisco, USA. From the 30th IEEE Conference on Signal Processing and Communications Applications, she received another Best Paper Award, in 2022. She received the 2022 Mojgan Daneshmand Grant from the IEEE Antennas and Propagation Society (AP-S), organized by the IEEE AP-S Young Professionals. Additionally, her Ph.D. thesis was awarded by Istanbul Technical University as the 'Outstanding Ph.D. Thesis' and the Turkish Electronics Industrialists Association (TESID) as the 'Best Innovation and Creativity Ph.D. Thesis' in 2022.



**PATRIZIA LIVRERI** (Member, IEEE) received the Laurea degree (Hons.) in electronics engineering, and the Ph.D. degree in electronics and communications engineering from the University of Palermo, Italy, in 1986 and 1992, respectively. From 1993 to 1994, she was a Researcher with the National Council for Researches, CNR, Tome, Italy. Since 1995, she has been serving as the Scientific Director for the Microwave Instruments and Measurements Laboratory' with the Department

of Engineering, University of Palermo. In 2020, she also joined the CNIT National Laboratory for Radar and Surveillance Systems RaSS, Pisa. She is currently a Professor with the Department of Engineering, University of Palermo, and a Visiting Professor with the San Diego State University. She is a Principal Investigator of the "Microwave Quantum Radar" project, funded by the Ministry of Defense, in 2021. She is a supervisor of many funded project and the author of more than 200 published papers. Her research interests include microwave and millimeter vacuum high power (TWT, Klystron) and solid-state power amplifiers for radar applications; high power microwave sources (virtual cathode oscillator and magnetically insulated transmission line oscillator); microwave and optical antennas; radar; and microwave quantum radar.



**NURHAN TÜRKER TOKAN** received the B.Sc. degree in electronics and communications engineering from Kocaeli University, in 2002, and the M.Sc. and Ph.D. degrees in communication engineering from Yildiz Technical University (YTU), Istanbul, Turkey, in 2004 and 2009, respectively. From May 2003 to May 2009, she was a Research Assistant in electromagnetic fields and microwave techniques with the Department of Electronics and Communication Engineering (ECE), YTU. From

May 2009 to April 2015, she was an Assistant Professor and from April 2015 to August 2021, she was an Associate Professor with the Department of ECE, YTU, where she has been a Professor, since August 2020. From October 2011 to October 2012, she was a Postdoctoral Researcher with the Department of Electrical Engineering, Mathematics and Computer Science (EEMCS), Delft University of Technology, Delft, The Netherlands. From October 2012 to May 2013, she was a Postdoctoral Fellow supported by the European Science Foundation with the Institute of Electronics and Telecommunications (IETR), University of Rennes1, Rennes, France. She is the author or coauthor of more than 50 papers published in peer-reviewed international journals and conference proceedings. Her current research interests include the analysis and design of antennas with an emphasis on dielectric lens antennas and wideband antennas, microwave circuits, and intelligent systems.



**GIOVANNI PAU** (Member, IEEE) received the bachelor's degree in telematics engineering from the University of Catania, Italy, and the master's (cum laude) and Ph.D. degrees in telematics engineering from Kore University of Enna, Italy. He is currently an Associate Professor with the Faculty of Engineering and Architecture, Kore University of Enna. He is the author/coauthor of more than 80 refereed papers published in journals and conference proceedings. His research interests include

wireless sensor networks, fuzzy logic controllers, intelligent transportation systems, the Internet of Things, smart homes, and network security. He has been involved in several international conferences as a session co-chair and a technical program committee member. He serves/served as a leading guest editor for special issues of several international journals. He is an Editorial Board Member and an Associate Editor of several journals, such as IEEE Access, *Wireless Networks* (Springer), *EURASIP Journal on Wireless Communications and Networking* (Springer), *Wireless Communications and Mobile Computing* (Hindawi), *Sensors* (MDPI), and *Future Internet* (MDPI).

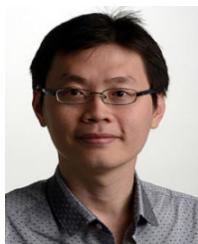

**CHAN HWANG SEE** (Senior Member, IEEE) received the B.Eng. (Hons.) degree in electronic, telecommunication and computer engineering and the Ph.D. degree from the University of Bradford, U.K., in 2002 and 2007, respectively. He is currently an Associate Professor with the School of Computing, Engineering and the Built Environment, Edinburgh Napier University, U.K., where he was the Head of Electrical Engineering and Mathematics from 2019 to 2022. He is a coauthor for one book and three book chapters. His research interests cover wireless sensor network system design, computational bioelectromagnetics, antennas, microwave circuits, Internet of Things (IoTs), microwave sensors, Wireless Power Transfer and acoustic sensor design. He has published over 250 peer-reviewed journal articles and conference papers in these research areas. He was a recipient of two Young Scientist Awards from the International Union of Radio Science (URSI) and Asia-Pacific Radio Science Conference (AP-RASC) in 2008 and 2010, respectively. He was awarded a certificate of excellence for his successful Knowledge Transfer Partnership (KTP) with Yorkshire Water on the design and implementation of a wireless sensor system for sewerage infrastructure monitoring in 2009. He was awarded an IEEE Malaysia AP/MTT/EMC Joint Chapter Best Paper Award in 2020. He is a Chartered Engineer, Fellow of the Institution of Engineering and Technology. He is also a Fellow of the Higher Education Academy, a full member of the EPSRC Review College, an Associate Editor for IEEE ACCESS and an Editor for *Journal of Electronics and Electrical Engineering*, *Scientific Reports*, *PeerJ Computer Science*, *PLOS One*, and *Wireless Power Transfer Journals*. According to Web of Science, he has completed over 500 verified reviews and over 250 verified editor records.



**ERNESTO LIMITI** (Senior Member, IEEE) has been a Research and Teaching Assistant, since 1991, and an Associate Professor, since 1998, with the Faculty of Engineering, University of Roma Tor Vergata, where he has also been a Full Professor of electronics, since 2002. He represents the University of Roma Tor Vergata in the governing body of the Microwave Engineering Center for Space Applications (MECSA), an inter-university center among several Italian universities. He has been elected to represent the industrial engineering sector in the Academic

Senate of the University from 2007 to 2010 and from 2010 to 2013. He is the President of the Consortium “Advanced Research and Engineering for Space,” ARES, formed between the university and two companies. Further, he is the President of the Laurea and Laurea Magistrale degrees in electronic engineering with the University of Roma Tor Vergata. The research activity is focused on three main lines, all of them belonging to the microwave and millimeter-wave electronics research area. The first one is related to the characterization and modeling of active and passive microwave and millimeter-wave devices. Regarding active devices, the research line is oriented to the small-signal, noise, and large-signal modeling. Regarding passive devices, equivalent-circuit models have been developed for interacting discontinuities in microstrip, for typical MMIC passive components (MIM capacitors) and to waveguide/coplanar waveguide transitions analysis and design. For active devices, new methodologies have been developed for the noise characterization and the subsequent modeling, and equivalent-circuit modeling strategies have been implemented both for small and large-signal operating regimes for GaAs, GaN, SiC, Si, and InP MESFET/HEMT devices. The second line is related to design methodologies and characterization methods for low-noise circuits. The main focus is on cryogenic amplifiers and devices. Collaborations are currently ongoing with the major radio astronomy institutes all around Europe within the frame of FP6 and FP7 programmed (RadioNet). Finally, the third line is in the analysis methods for nonlinear microwave circuits. In this line, novel analysis methods (Spectral Balance) are developed, together with the stability analysis of the solutions making use of traditional (harmonic balance) approaches. The above research lines have produced more than 250 publications in refereed international journals and presentations at international conferences. He acts as a referee of international journals of the microwave and millimeter wave electronics sector. He is on the steering committee of international conferences and workshops. He is actively involved in research activities with many research groups, both European and Italian, and he is in tight collaborations with high-tech Italian (Selex-SI, Thales Alenia Space, Rheinmetall, Elettronica S.p.A., and Space Engineering) and foreign (OMMIC, Siemens, and UMS) companies. He contributed, as a researcher and/or as the unit responsible, to several National (PRIN MIUR, Madess CNR, and Agenzia Spaziale Italiana) and international (ESPRIT COSMIC, Manpower, Edge, Special Action MEPI, ESA, EUROPA, Korrigan, and RadioNet FP6 and FP7) projects. Regarding teaching activities, he teaches, over his institutional duties in the frame of the Corso di Laurea Magistrale in Ingegneria Elettronica, “Elettronica per lo Spazio” within the Master Course in Sistemi Avanzati di Comunicazione e Navigazione Satellitare. He is a member of the committee of the Ph.D. program in telecommunications and microelectronics with the University of Roma Tor Vergata, tutoring an average of four Ph.D. students per year.

...